

SILENT *Bass*TM

SLB-100

Owner's Manual

Thank you for purchasing the Yamaha SILENT BassTM. In order to obtain the maximum performance and enjoyment from your SILENT BassTM, we urge you to read this Owner's Manual thoroughly before using the instrument. Please keep this Owner's Manual in a safe place for later reference.

Contents

Precautions	3
Main Body/Accessories	4
Nomenclature	5
Setup	7
■ Tuning	7
■ Attaching the Frame Unit	9
■ About the End Pin	10
■ Putting the Instrument into the Soft Case.....	10
■ Changing Strings	11
■ About the Mute	12
Power Supply	13
■ Using the Battery	13
■ Supplying AC Power	13
Connecting External Devices	14
Using the Controls	16
Specifications	17

SPECIAL MESSAGE SECTION

This product utilizes batteries or an external power supply (adaptor). DO NOT connect this product to any power supply or adaptor other than one described in the manual, on the name plate, or specifically recommended by Yamaha.

This product should be used only with the components supplied or; a cart, rack, or stand that is recommended by Yamaha. If a cart, etc., is used, please observe all safety markings and instructions that accompany the accessory product.

SPECIFICATIONS SUBJECT TO CHANGE: The information contained in this manual is believed to be correct at the time of printing. However, Yamaha reserves the right to change or modify any of the specifications without notice or obligation to update existing units.

Do not attempt to service this product beyond that described in the user-maintenance instructions. All other servicing should be referred to qualified service personnel.

This product, either alone or in combination with an amplifier and headphones or speaker/s, may be capable of producing sound levels that could cause permanent hearing loss. DO NOT operate for long periods of time at a high volume level or at a level that is uncomfortable. If you experience any hearing loss or ringing in the ears, you should consult an audiologist.

IMPORTANT: The louder the sound, the shorter the time period before damage occurs.

NOTICE: Service charges incurred due to a lack of knowledge relating to how a function or effect works (when the unit is operating as designed) are not covered by the manufacturer's warranty, and are therefore the owner's responsibility. Please study this manual carefully and consult your dealer before requesting service.

ENVIRONMENTAL ISSUES: Yamaha strives to produce products that are both user safe and environmentally friendly. We sincerely believe that our products and the production methods used to produce them meet these goals. In keeping with both the letter and the spirit of the law, we want you to be aware of the following:

Battery Notice: This product MAY contain a small non-rechargeable battery which (if applicable) is soldered in place. The average life span of this type of battery is approximately five years. When replacement becomes necessary, contact a qualified service representative to perform the replacement.

This product may also use "household" type batteries. Some of these may be rechargeable. Make sure that the battery being charged is a rechargeable type and that the charger is intended for the battery being charged.

When installing batteries, do not mix old batteries with new, or with batteries of a different type. Batteries MUST be installed correctly. Mismatches or incorrect installation may result in overheating and battery case rupture.

Warning: Do not attempt to disassemble or incinerate any battery. Keep all batteries away from children. Dispose of used batteries promptly and as regulated by the laws in your area. Note: Check with any retailer of household type batteries in your area for battery disposal information.

Disposal Notice: Should this product become damaged beyond repair, or for some reason its useful life is considered to be at an end, please observe all local, state, and federal regulations that relate to the disposal of products that contain lead, batteries, plastics, etc. If your dealer is unable to assist you, please contact Yamaha directly.

NAMEPLATE LOCATION: The nameplate is located on the bottom of the product. The model number, serial number, power requirements, etc., are located on this plate. You should record the model number, serial number, and the date of purchase in the spaces provided below and retain this manual as a permanent record of your purchase.

Model

Serial No.

Purchase Date

PLEASE KEEP THIS MANUAL

92-BP

Your SILENT Bass™ will give you years of reliable service if you follow the simple rules given below:

■ Location

Do not expose it to the following conditions to avoid deformation, discoloration, or more serious damage.

- Direct sunlight (e.g. near a window).
- High temperatures (e.g. near a heat source, outside, or in a car during the daytime).
- Excessive humidity.
- Excessive dust.
- Strong vibration.

■ Power Supply

- Turn the power switch OFF when not in use.
- If you use an AC power adaptor, unplug the adaptor from the AC outlet if not to be used for an extended period of time.
- Unplug the AC power adaptor during electric storms.
- Avoid plugging the AC power adaptor into the same AC outlet as appliances with high power consumption, such as electric heaters or ovens. Also avoid using multi-plug adaptors since these can result in reduced sound quality and possibly damage.

■ Turn Power OFF When Making Connections

- To avoid damage to the SILENT Bass™ and other devices to which it is connected (a sound system, for example), turn the power switches of all related devices OFF prior to connecting or disconnecting audio cables.

■ Handling and Transport

- Never apply excessive force to the controls, connectors or other parts.
- Always unplug cables by gripping the plug firmly, not by pulling on the cable.
- Disconnect all cables before moving the unit.
- Physical shocks caused by dropping, bumping, or placing heavy objects on the unit can result in scratches and more serious damage.

■ Cleaning

- Clean the cabinet and panel with a dry soft cloth.
- A slightly damp cloth may be used to remove stubborn grime and dirt.
- Never use cleaners such as alcohol or thinner.
- Avoid placing vinyl objects on top of the unit (vinyl can stick to and discolor the surface).

■ Electrical Interference

- This unit contains electric circuitry and may cause interference if placed too close to radio or television receivers. If this occurs, move it further away from the affected equipment.

Yamaha is not responsible for damage caused by improper handling or operation.

Information for Users on Collection and Disposal of Old Equipment and used Batteries



These symbols on the products, packaging, and/or accompanying documents mean that used electrical and electronic products and batteries should not be mixed with general household waste. For proper treatment, recovery and recycling of old products and used batteries, please take them to applicable collection points, in accordance with your national legislation and the Directives 2002/96/EC and 2006/66/EC.

By disposing of these products and batteries correctly, you will help to save valuable resources and prevent any potential negative effects on human health and the environment which could otherwise arise from inappropriate waste handling.

For more information about collection and recycling of old products and batteries, please contact your local municipality, your waste disposal service or the point of sale where you purchased the items.



[For business users in the European Union]

If you wish to discard electrical and electronic equipment, please contact your dealer or supplier for further information.



[Information on Disposal in other Countries outside the European Union]

These symbols are only valid in the European Union. If you wish to discard these items, please contact your local authorities or dealer and ask for the correct method of disposal.

Note for the battery symbol (bottom two symbol examples):

This symbol might be used in combination with a chemical symbol. In this case it complies with the requirement set by the Directive for the chemical involved.

Cd

Main Body/Accessories

After opening the packaging, please check that all the parts listed below are included.

• Main Body x1

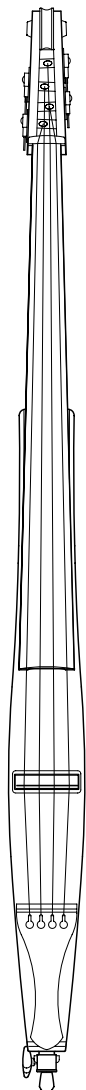

• Frame Unit x1

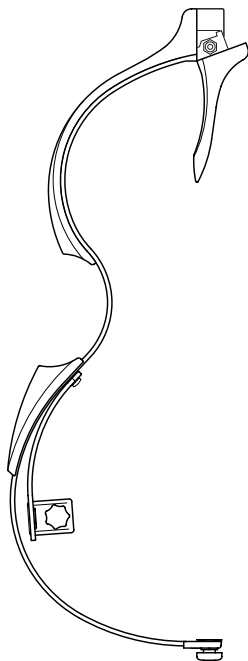

• Mute x1

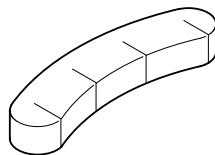

• Allen Wrench x1

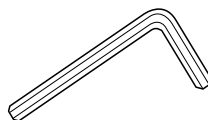

* Use an optional Yamaha Power Adaptor (see page 17) for powering the instrument with a power adaptor.

* To play SLB-100, you will need 6F22 (S-006P) 9V battery.

Option

- AC Adaptor
- Stand for SILENT Bass™ (BST1)
- Knee support for SILENT Bass™ (BKS1)
- Soft case for SILENT Bass™ (BSC1)

To purchase the optional accessories shown above, please inquire at your authorized Yamaha dealer.

Nomenclature

● Front

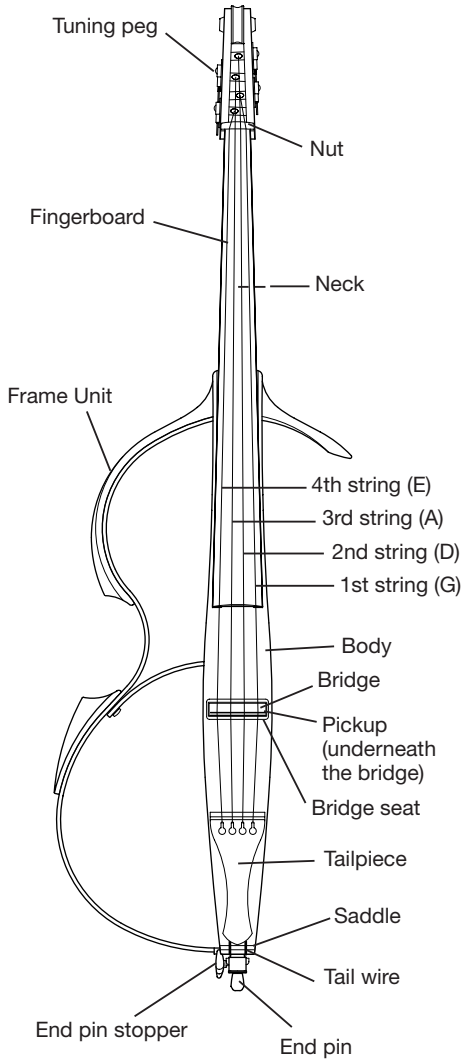

● Rear

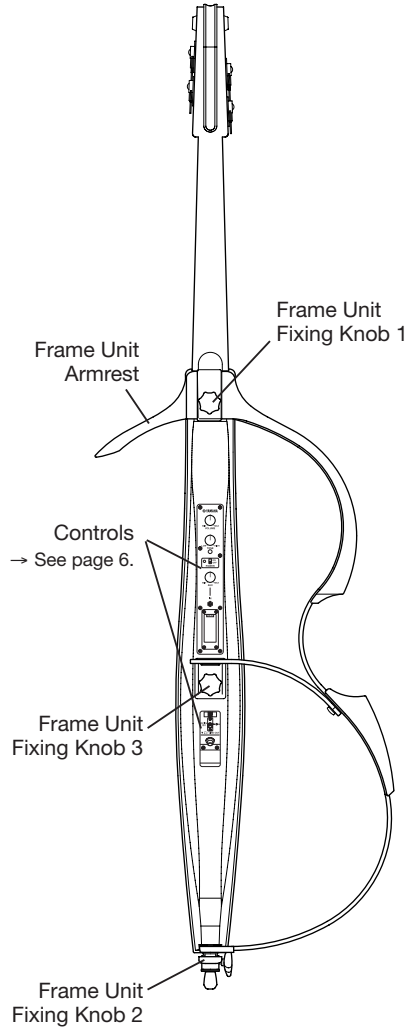

● Controls

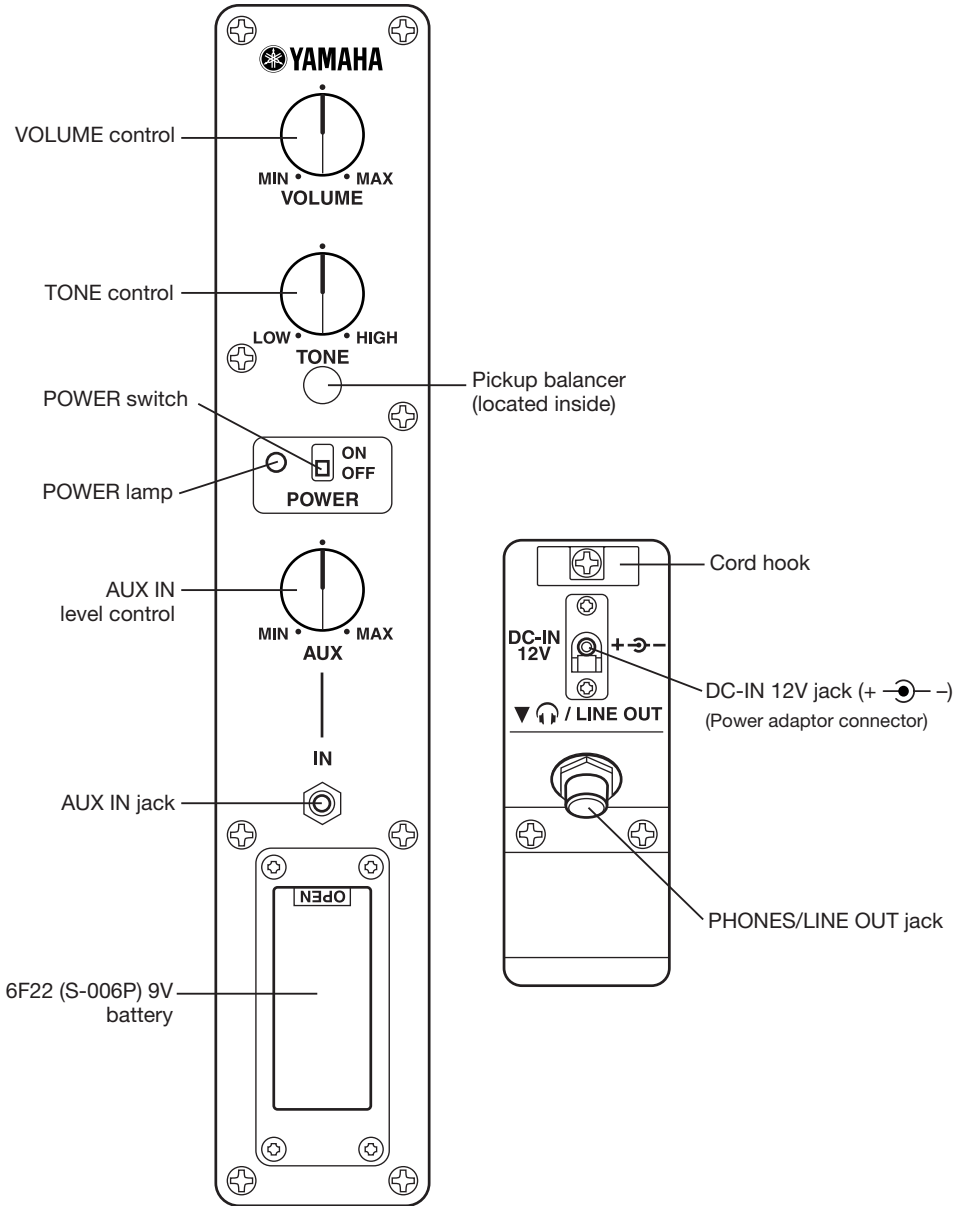

Setup

■ Tuning

The SILENT Bass™ is shipped from the factory with the bridge in place and the strings slightly loosened. The bridge's height is set to an average height.

Since the position of the bridge will sometimes shift during transport, please properly adjust the position of the bridge before tuning the strings.

- The lower side of the bridge supports the 1st string (G), the higher side supports the 4th string (E). When looking at the bridge from the side, the surface that has a sharper curve should face the fingerboard. (Facing up when in the playing position). (Fig. 1)
- The side of the bridge facing the tailpiece should be at a right angle compared to the body. (Fig. 2)
- The height of the instrument's bridge is adjustable. Turning the round legs clockwise will raise the bridge higher. Turning the round legs counter-clockwise will lower the bridge's height. (Fig. 3)

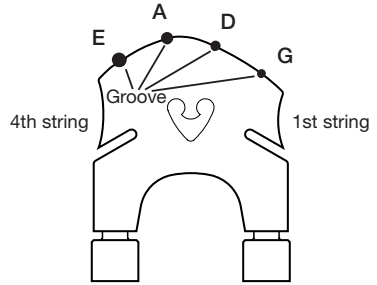

[Fig. 1 : Looking from the tailpiece]

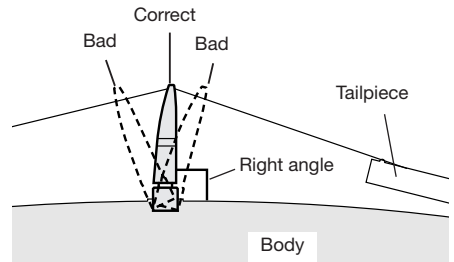

[Fig. 2 : Bridge stands vertically]

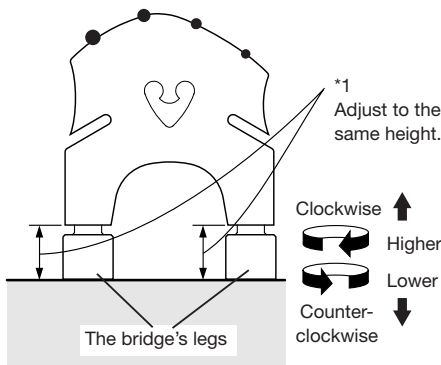

[Fig. 3 : Adjusting bridge height]

- Before adjusting the bridge's height, make sure that the strings are loosened so that the legs can turn easily. If string tension is too tight and the legs are turned by force, it may result in damage to the bridge, pickup, etc.
- Make sure that both of the bridge's legs are adjusted to the same height. If both legs are not stable and string tension is increased, the bottom of the bridge will not have adequate contact with the pickup resulting in poor sound quality, noise, damage, etc. (Fig. 3-*1)

- The strings are tuned to the following pitches. The 1st string is tuned to G, the 2nd string to D, the 3rd string to A, and the 4th string to E. Use a piano, tuning fork, tuner, etc., and adjust the pitch of each string using the tuning pegs.

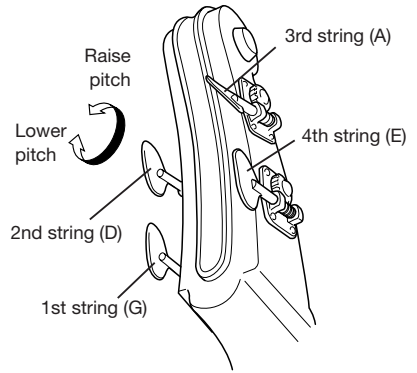

- After tuning is complete, make sure that the tailpiece side of the bridge is still properly aligned. If the bridge is leaning in either direction, slightly loosen the strings and carefully re-align the bridge using both hands.

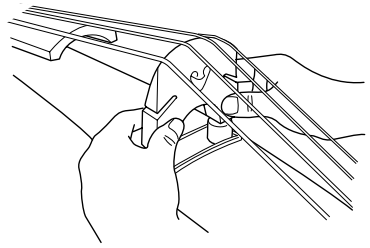

Caution

Make sure that the Tail Wire is correctly positioned on top of the Saddle.

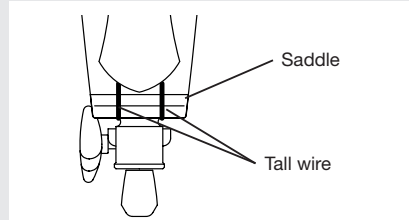

● Tuning machine tension adjustment

The tuning machine's tension that regulates the amount of pressure required to turn the tuners can be adjusted using the supplied Allen wrench.

- * If the tuning machine turns with very slight pressure → Rotate the adjustment screw to the right (clockwise: **A**).
- * If the tension is tight and the tuning machine is hard to turn → Rotate the adjustment screw to the left (counter-clockwise: **B**).

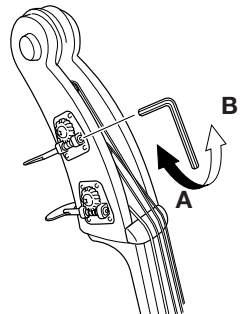

■ Attaching the Frame Unit

The SILENT Bass™ is shipped from the factory with the Frame Unit removed from the main body.

Please properly attach the Frame Unit using the following procedure.

- 1 Open the frame unit's armrest until it comes in contact with the stopper.
- 2 Fully loosen the [Fixing Knob 2] located on the bottom end of the main body.
- 3 Align the cut end of the Frame Unit with the post above the [Fixing Knob 2] and fully insert. Then, align the notch at the top of the Frame Unit so it rests on the top of the bass' main body and slowly insert.
- 4 Turn the [Fixing Knob 1] located on the upper portion of the frame unit clockwise until it is tight, to attach the frame unit to the body.
- 5 Turn the [Fixing Knob 2] on the bottom end of the main body clockwise (looking from the bottom) until it is tight, to attach the frame unit to the body.
- 6 Align the [Fixing Knob 3], located on the center of the frame unit, with the Fixing Knob Plate located on the center of the main body, then turn clockwise to tighten.

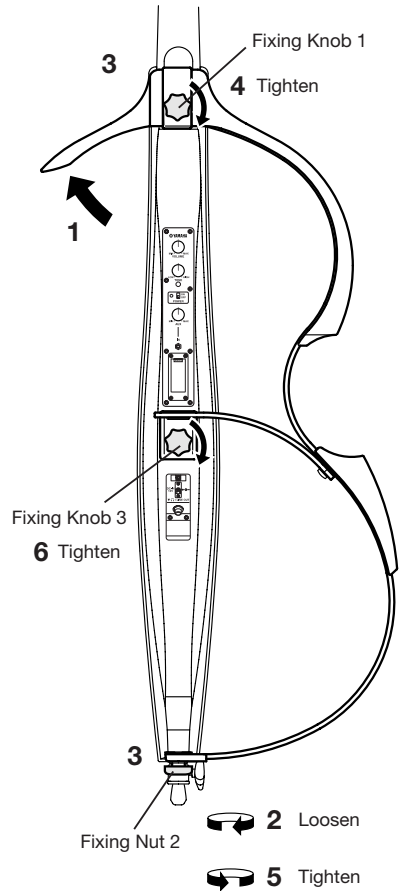

When you move the frame unit's center section, be careful not to pinch your fingers, hand, etc.

This completes attachment of the frame unit.

To remove the frame, simply reverse the order of the previous procedure.

- Make sure that Fixing Knobs 1-3 are tightened firmly. If they are left loose, it may result in rattle or noise during performance.
- When transporting the instrument, always hold it by its neck or main body. Holding by the frame unit only may result in damage to the frame unit.

■ About the End Pin

Loosen the end pin stopper, extend the end pin to a comfortable length for playing and firmly tighten the end pin stopper.

- Make sure the end pin stopper is secured firmly to prevent the instrument from falling while you play.

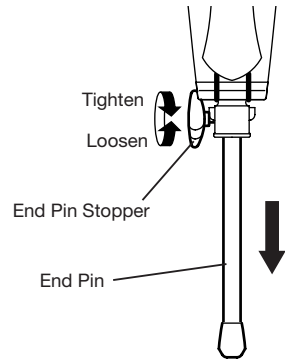

■ Putting the Bass into the Optional Soft Case

Before putting the bass into the optional SILENT Bass™ soft case, remove the frame unit from the SILENT Bass™ and pack the components into the case as shown in the diagram below.

- Use the Velcro® fasteners (2 locations) inside the case to secure the frame unit in place.
- When putting the bow in the soft case, make sure that it is first put into the hard bow case, then place the hard case in the pocket and secure with a Velcro® fastener (1 location).
- When the case is placed on its side with the instrument packed inside, make sure that the side holding the main unit is placed on the bottom (so the side with the frame is on top).

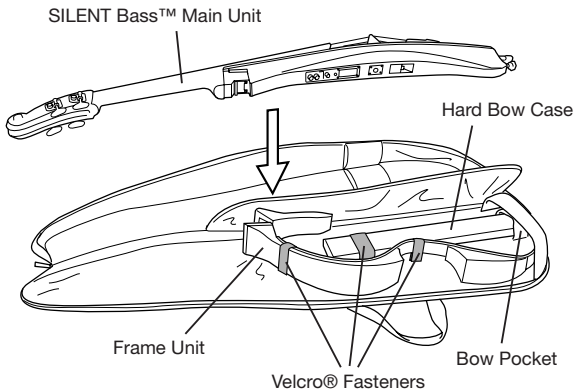

The soft case does not fully protect parts such as the bridge from damage.

The soft case is meant for storing and transportation of the instrument and protects it from dust, etc. Do not place the bridge so it is on the bottom of the case and do not cause damage to the instrument by placing objects on top of the case, hitting it, etc.

■ Changing Strings

As the strings get old, sound quality will gradually decrease, and it will become difficult to tune the instrument. Change the strings as soon as you think they are getting old. Make sure you purchase Double Bass strings. The SILENT Bass™ uses a string length of 1,054 mm (41.5 inch).

- The end of the strings are sharp and can cut fingers. Use caution when changing strings.
- When changing or adjusting strings, do not put your face close to the instrument. The string may suddenly break resulting in eye or other unexpected injuries.

Winding the Strings

1 Hook the ball located on the end of the string in the string hole on the tailpiece. At this time, make sure that the ball is properly inserted in the notch of the string hole.

- * If the ball end is bigger than the string hole, thread the string from the back of the tailpiece.

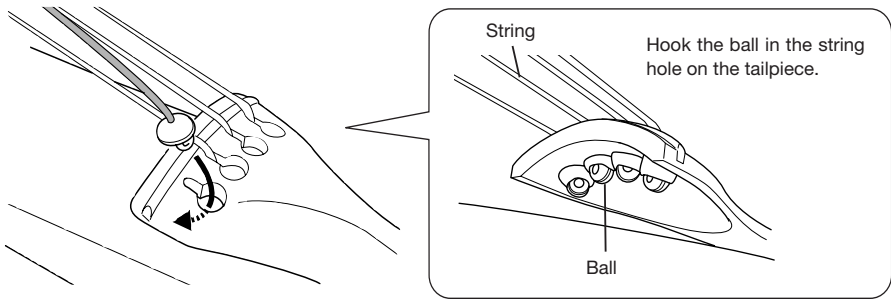

2 Insert the other end of the string into the hole on the tuning peg. Rotate the tuning peg. As shown in the illustration, wind the string on the side away from the peg handle once around the peg, then return the string back overlapping that wind so that the remaining slack is wound gradually toward the peg handle. 1st (G) and 2nd (D) strings are shown on the left, 3rd (A) and 4th (E) strings on the right.

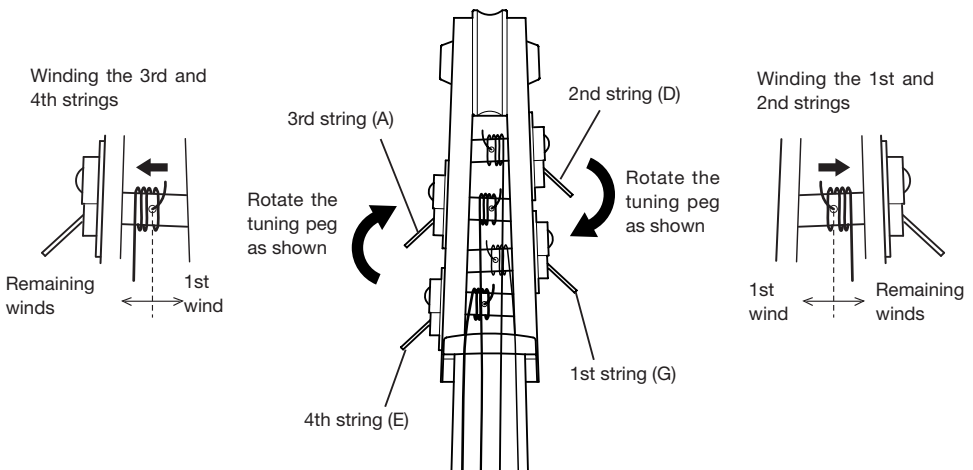

Make sure the bridge is at a right angle.

Also, make sure each of the strings are positioned in their corresponding grooves.

- * **Make sure the tailpiece side of the bridge stands vertically in relation to the body.**

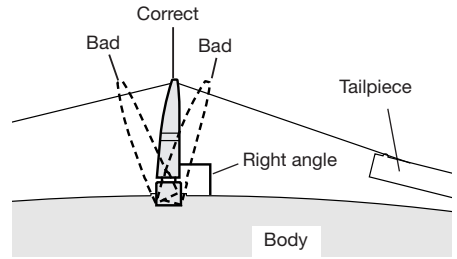

3 Use a piano, tuning fork, tuner, etc., and adjust the pitch of each string using the tuning pegs.

* Refer to the “Tuning” section (page 7).

- When the instrument is not being used for an extended period of time, loosen the strings.
- Before using the instrument, make sure that the bridge is positioned vertically. Damage to the bridge and poor sound quality may result if the bridge is not properly positioned.

■ About the Mute

Due to the design of the Yamaha SILENT Bass™, the pickups also pickup vibration of the strings between the bridge and the tailpiece. At times this extraneous vibration may occur. If the sound is unpleasant, attach the supplied mute to the strings near the upper end of the colored thread wrappings on the strings as shown in the illustration below.

- The mute will have little effect if it is attached midway between the bridge and the tailpiece. Please take note.

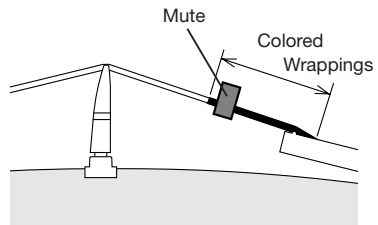
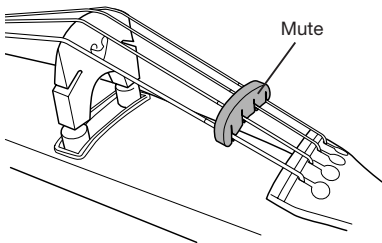

Power Supply

The SILENT Bass™ can be operated with either battery or AC power. Always turn the power switch on the rear panel OFF before making AC power connections or replacing the battery.

■ Using the Battery

- 1 Open the battery case located on the backside of the instrument by pulling the tab labeled “OPEN” toward you, then open the battery compartment cover.
- 2 Insert the battery (6F22:S-006P) into the battery compartment. Take careful note of the polarity markings (+/-) as shown in the illustration when inserting the battery.
- 3 Close the battery compartment cover and push the battery case all the way back into the instrument body.

* For customers in the Netherlands

Bij dit produkt zijn batterijen geleverd.
Wanneer deze leeg zijn, moet u ze niet
weggoien maar inleveren als KCA.

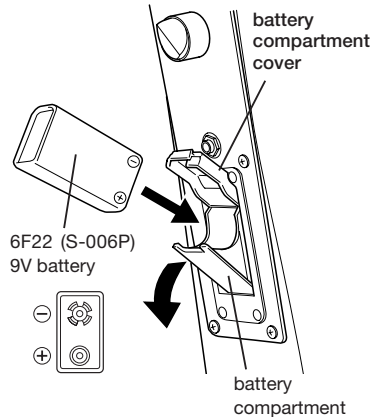

When the battery is low, the lamp will dim and the sound may become distorted or noisy. When these symptoms occur, please take note of the following precautions and replace the battery.

- When replacing the battery, purchase a replacement battery that properly fits the battery holder (battery designs differ among makers). Too big a battery may damage the instrument. Too small a battery may result in poor conductivity.
- Always follow the +/- signs when inserting the battery. Improper insertion may result in fire.
- To prevent possible damage to the unit due to battery leakage and unnecessary power drain, remove the battery from the unit when it is not going to be used for an extended period of time.

■ Supplying AC Power

AC adaptor is optional, please purchase the optional power adaptor (Refer to page 17).

- 1 Plug the adaptor's DC output cable into the SILENT Bass™'s DC IN 12V jack located on the back of the instrument, making sure the plug is firmly inserted into the jack.
- 2 Plug the AC adaptor into a convenient wall AC power socket.

- Battery power is automatically disconnected when the AC adaptor is connected.
- When the AC adaptor is used, the batteries may leak. To prevent leakage we recommend that you remove the batteries from the instrument.
- When using an AC adaptor, make sure you use only the appointed compatible adaptor. The use of an incompatible adaptor may result in damage to the instrument or cause fire, etc. Please use with caution.

Connecting External Devices

- **Using the cord hook**

Wrap the Power Adaptor's cord around the cord hook (prevents cord from being unplugged).

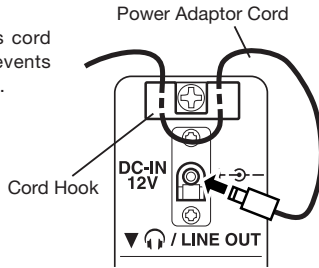

SILENT Bass™

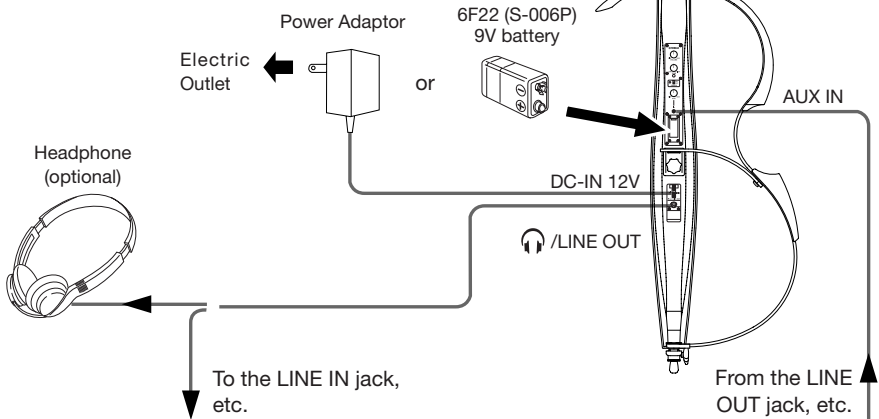

Bass Amplifier,
Powered Speaker

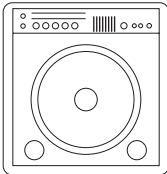

Electronic Tuner

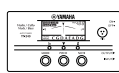

* Power rating of 50W or more is recommended

P.A. Mixer, Recording Device

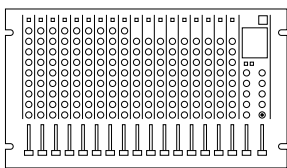

CD Player

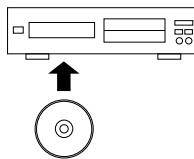

MD Player

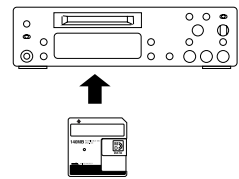

Cassette Player



Electronic Metronome





When connecting the instrument to external audio equipment, check the jack size and make sure to use a plug size that corresponds to the jack being used, and properly connect the cable to the jack.

■ AUX IN jack

- The AUX IN jack, located on the rear of the instrument, can be used to connect an external stereo signal source to the SILENT Bass™. Connecting the audio output of a CD player, cassette player, etc. to the instrument allows you to play along with the external audio source.
- The AUX IN jack's signal level can be controlled with the AUX IN level control.
- The VOLUME control is used to adjust the total level of the output signal. This signal contains the AUX IN signal that is controlled by the AUX IN level control knob too.

■ LINE OUT jack

- The /LINE OUT jack located on the rear panel provides stereo output for the SILENT Bass™ (the bass signal is mono while the AUX IN signal is stereo). When a device other than headphones is used for monitoring the instrument, use an optional stereo phone plug cable (or monaural phone plug cable) to connect the instrument to the audio input jack of a bass amplifier, external powered speaker, mixing console, etc., to listen from external audio equipment or recording. You can also connect this jack to the INPUT jack on an electronic tuner and tune the SILENT Bass™ like an electronic instrument using the instrument's output signal.

- **Before connecting the SILENT Bass™ to any external devices, make sure that the power of all related devices is turned OFF. Set the volume level of any external audio sources to the minimum level before connecting anything. High volume settings could cause damage to the equipment and your hearing.**
- **If a connection cord is unplugged while the power is ON, it may result in damage to the equipment. The sudden shock to your ears may be great, so please use with care.**
- **Be careful not to step on the cord. The cord may break, equipment may be damaged, and this may cause a substantial shock to your ears.**
- **The signal from the SILENT Bass™'s output jacks must NEVER be returned to the AUX IN jack, either directly or through external equipment. Doing so will result in feedback which may cause damage to the internal electronics.**
- **When a powered speaker is connect to the  /LINE OUT jack, speakers with inadequate power ratings may distort due to the low frequencies produced by the instrument. For sufficient headroom, used powered speakers with a power rating of 50 watts or more.**

Using the Controls

- 1 Turn the POWER switch on the rear panel to its “ON” position. The SILENT Bass™ will be powered and the lamp will light.
- 2 Use a cable with a standard 1/4 inch phone plug to connect the /LINE OUT jack on the rear panel to the input jack on a bass amp or powered speaker, etc.
Also, connecting a pair of headphones to this jack will allow you to practice in private without the use of an amp.

- Before making any connections, make sure the volume is turned down on the amplifier, powered speaker, etc. or its power is switched OFF.
- Do not make any connections when you are wearing the headphones over your ears.

- 3 Rotate the VOLUME dial to adjust the volume to a suitable level.

- When using the headphones, do not operate at high volume levels for long periods of time. Doing so can lead to irreparable damage to your hearing.
- If the sound is distorted when playing strongly, try turning the volume knob slightly to the left.

- 4 Use the TONE dial to control the instrument’s tone quality. Rotate the dial to the right (HIGH) to increase high frequencies. Rotate the dial to the left (LOW) to increase low frequencies.

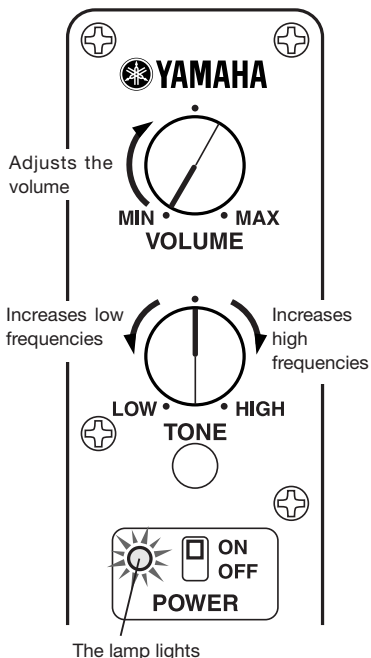

● Pickup balance adjustment



The SILENT Bass™ pickup system consists of two sensors, one for low strings the other for high. Depending upon the type of strings and your playing style, you might want to adjust the balance of the high and low sensors. If so, please use the following procedure.

- 1 Remove the rubber cover located under the TONE knob on the rear section of the main body.
* Do not lose this cover.
- 2 Use a non-conductive screwdriver (made of plastic or resin so it does not conduct electricity) to turn the balance control located inside the hole and adjust the balance. Turn to the right (clockwise) to increase the volume of the high sensor. Turn to the left (counter-clockwise) to increase the volume of the low sensor.
* Do not turn the balance control too much.
- 3 After adjustment is complete, replace the rubber cover.

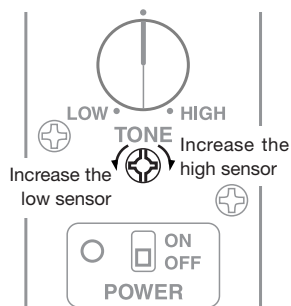
HINT If your playing uses mostly a pizzicato style, we suggest slightly boosting the bass side. If you mainly use a bow, a center setting may be best.



Specifications

Neck	Maple
Body	Spruce + Mahogany
Fingerboard	Rosewood
Bridge	Maple (height is adjustable)
Frame Unit	Beech + Aluminum frame
Tuning Pegs	Custom Worm Gear Type
Tail Piece	Ebony
Strings	Contra Bass Strings (Ball-end type)
Sensors	2 Piezo Pickups
Connectors/Controls	<ul style="list-style-type: none">• AUX IN (w/Level Control)•  (Headphone)/LINE OUT output jack for normal use.• Volume• Tone control
Power	<ul style="list-style-type: none">• POWER Switch (OFF/ON)• Battery: 6F22(S-006P)/6LR61 9V battery x1* *Rechargeable batteries cannot be used.• Power Adaptor (sold separately): Yamaha PA3C (for use in Japan), PA130 (for use internationally), DC 12 V/700 mA +  -
Power Consumption	2.5W (with the PA3C), 1.0W (with the PA130, PA130A), 1.1W (with the PA130B)
Battery Life (Continuous Use)	Using Manganese battery : approximately 12 hours Using Alkaline battery : approximately 24 hours
String Length	1,054 mm (41.5")
Dimensions (with the frame attached and the End Pin fully contracted)	1,735 (L) x 525 (W) x 435 (H) mm 68.3" (L) x 20.7" (W) x 17.1" (H)
Weight	approximately 10 kg (22 lbs.)

* Design and specifications are subject to change without notice.

ヤマハ株式会社

〒430-8650 静岡県浜松市中区中沢町10-1