

DIGITAL KEYBOARD

REFERENCE MANUAL

— **PSR-E283**

— **YPT-280**

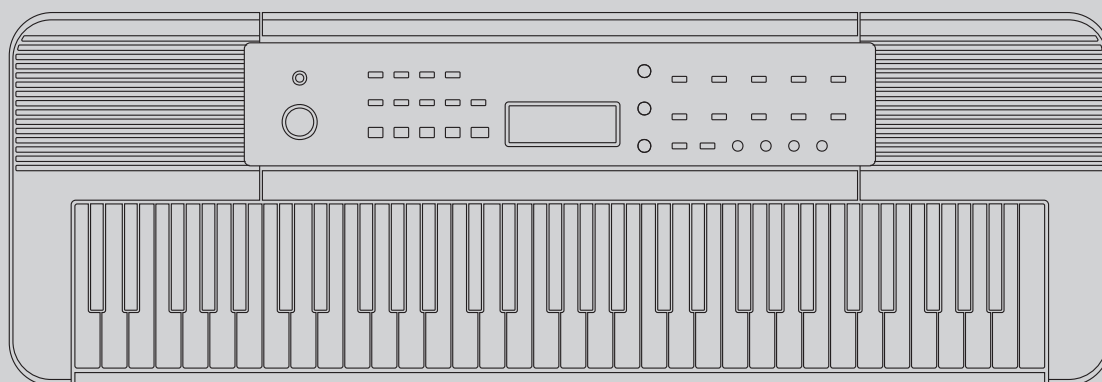

About the Manuals

The following manuals are provided for the instrument.

■ Printed Manual



Owner's Manual (included with the product)

Explains the basic operations of the instrument. The manual also includes "PRECAUTIONS" that you must read before use.

■ Online Material



Reference Manual (this document)

In addition to the contents of the Owner's Manual, detailed explanations of all functions including more detailed operating procedures and applied functions are provided. You can also check a list of Voices, Songs, Styles, etc. installed on the instrument.

■ Video Manuals

Video manuals explaining how to use this instrument are available.



Scan the two-dimensional code to the left or access the website below.

<https://manual.yamaha.com/mi/kb-ekb/psr-e283/movies/>

* If subtitles for your language are not displayed, set them with the "Subtitles/closed captions (cc)" and "Settings" buttons in the lower right of the YouTube screen.



"Settings" button (Sets the language of the subtitles, etc.)

"Subtitles/closed captions (cc)" button (Switches the subtitle display on/off.)

Downloading the Song Book

Use the free downloadable songbook when playing this instrument. You can download the Song Book from the "PSR-E283 related data download" website below.

PSR-E283 related data download:



<https://manual.yamaha.com/mi/kb-ekb/psr-e283/downloads/>



SONG BOOK

This contains music scores for the preset Songs (excluding the Demo Songs) of this instrument.

■ Notation Rules

Button names: Buttons on the panel are indicated with []. The number after the button name indicates the number in "Panel Controls and Terminals" (pages 8–9). For example, the demo button is written as [DEMO] ③ in the text.

Included Accessories

- Owner's Manual ×1
- Music rest ×1
- AC adaptor* ×1
- Online Member Product Registration ×1

* May not be included depending on your area. Check with your Yamaha dealer.

Contents

About the Manuals	2
Included Accessories	2
Contents	3
Setting Up	5
Power Requirements	5
Turning the Power On/Off	6
Auto Power Off Function	6
Adjusting the Master Volume	7
Connecting Headphones or External Speakers	7
Using a Pedal (Sustain)	7
Using the Music Rest	7
Panel Controls and Terminals	8
Basic Operations and Display Items	10
Basic Operations	10
Display Items	11
Playing a Song	12
Select a Voice and Play!	14
Selecting a Voice	14
Selecting the Best Voice for the Song or Style (One Touch Setting)	14
Playing Various Sound Effects	14
Calling up the Grand Piano Voice	14
Using the Metronome	15
Adjusting the Tempo	15
Playing with Enhanced, More Spacious Sound (Ultra-Wide Stereo)	15
Applying Effects to the Sound	16
Playing the Keyboard with Two People (Duo Mode)	17
Select a Song and Listen!	18
Selecting and Playing a Preset Song	18
Listening to a Demo Song	18
Playing Songs Continuously (Background Music Function)	19
Song Fast Forward, Fast Reverse, and Pause	19
Changing the Melody Voice of a Preset Song	19
Listening to Part of a Song Repeatedly (A-B Repeat)	20
Turning Each Part On/Off	20
Using the Song Lesson Feature	21
Listening, Timing, and Waiting	21
Practicing with a Song Lesson	21
Hearing and Experiencing the Sounds of the Chords (Chord Study)	22
Hearing and Experiencing the Sound of a Single Chord	22
Hearing and Experiencing Basic Chord Progressions	22
Playing Along with Rhythm and Auto Accompaniment (Styles)	23
Playing Along with Auto Accompaniment (Styles)	23
Style Variations (Sections)	24
Selecting How to Play a Chord (Fingering Type)	25
Setting the Fingering Type	25
Setting the Smart Chord Key	25
Chord Types for Style Playback	26
Chords Played in Smart Chord Function	27

Have Fun with Sound Quizzes and Rhythms!	28
Try Guessing the Sound! (Sound Quiz).....	28
Try the Memory Quiz!.....	28
Play with Rhythm! (Rhythm Tutor).....	28
Recording Your Performance (Phrase Recording)	29
Selecting an EQ Setting for the Best Sound	30
Playing an External Audio Device with the Built-in Speakers	31
Function Settings	32
Backup and Initialization	35
Backup Parameters	35
Initialization (Backup Clear).....	35
Troubleshooting	36
Voice List	38
SFX Kit List	41
Drum Kit List	42
Song List	45
Style List	46
Effect Type List	47
Specifications	48
Index	49

Setting Up

Power Requirements

Although this instrument can draw power either from an AC adaptor or batteries, Yamaha recommends the use of an AC adaptor whenever possible.

Using an AC Adaptor

Connect the AC adaptor in the order shown in the illustration.

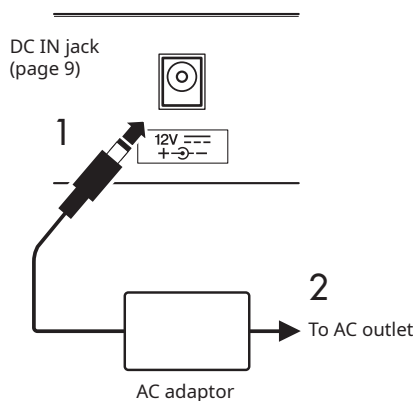

WARNING

- Use only the supplied or specified AC adaptor (page 48). Using a different power adaptor may cause a malfunction, overheating, fire, etc. Note that in such cases, Yamaha may not be able to guarantee the product even within the warranty period.
- When using an AC adaptor with a removable plug, make sure to keep the plug attached to the AC adaptor during use and storage. Inserting just the plug into an outlet can cause electric shock or fire.
- Never touch the inner metallic section of the plug to avoid electric shock, short circuit, or damage. If the plug comes off, push it in until it securely clicks in place. Also be careful that there is no dust or other foreign matter between the AC adaptor and plug.

For PA-130

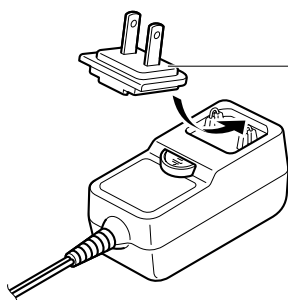

Plug

- Place the plug against the far side, and then firmly push it in until it clicks.
- The shape of the plug differs depending on your area.

- When setting up the instrument, make sure that the AC outlet you are using is easily accessible. If trouble or a malfunction occurs, immediately press the [⏻] (Standby/On) switch (page 6) to turn the power off and disconnect the plug from the outlet.

NOTE

- When disconnecting the AC adaptor, turn off the power of the instrument and follow the order shown above in reverse.

Using Batteries

This instrument can use AA size alkaline, manganese dry cell, or rechargeable nickel metal hydride batteries (rechargeable batteries). However, the use of alkaline or rechargeable batteries is recommended, as the instrument may consume large amounts of power depending on use.

WARNING

- When the batteries run out, or if the instrument is not to be used for a long time, remove the batteries from the instrument.

- 1 Make sure that the power of the instrument is off.
- 2 Turn the instrument over on a soft cloth or cushion and open the battery compartment cover located on the bottom panel.

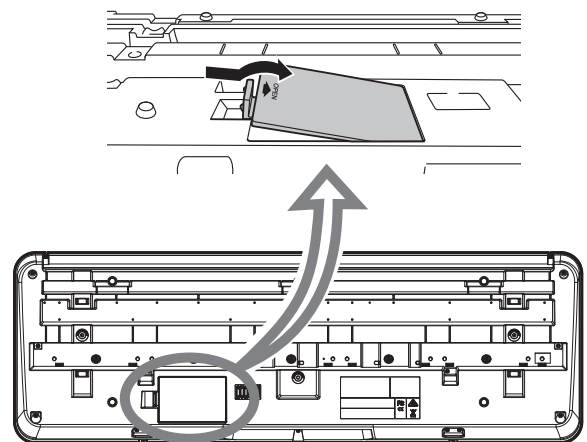

- 3 Insert the six new batteries, being careful to follow the polarity markings on the inside of the compartment.

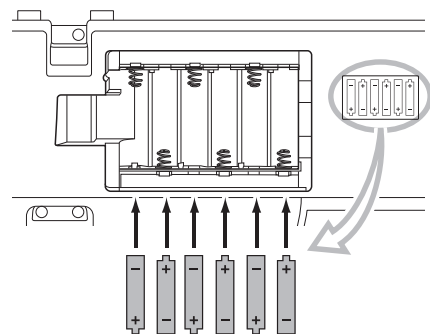

- 4 Replace the compartment cover, making sure that it locks firmly in place.

Make sure your instrument settings are configured correctly according to the type of battery you are using (page 6).

NOTICE

- Do not connect or disconnect the power adaptor while batteries are inserted and the power is turned on. Doing so will cause the power to temporarily turn off and any data being recorded to be lost.
- When battery power becomes too low for proper operation, the volume may be reduced, the sound may be distorted, and other problems may occur. When this happens, make sure to replace all batteries with new ones or already recharged ones.

NOTE

- This instrument cannot be used to charge the batteries. Use only the specified charger device when charging.
- Even if batteries are inserted into the instrument, the AC adaptor will be used as the power source when the AC adaptor is connected.

■ Setting the battery type

Change the setting on the instrument (dry cell or rechargeable batteries) according to the battery type to be used. Dry cell batteries are set by default. After turning the power on, set the battery type via Function number 029 (page 34). For details on how to check and change settings, see “Function Settings” (page 32).

Alkaline	Alkaline batteries or manganese batteries
Ni-MH	Rechargeable nickel metal hydride batteries

NOTICE

- Failure to set the battery type may shorten the amount of the battery life. Make sure to set the battery type correctly.

Turning the Power On/Off

1 Turn down the [MASTER VOLUME] dial to “MIN.”

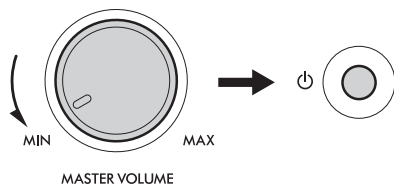

2 Press the [⏻] (Standby/On) switch to turn the power on.

The Voice name will appear on the display. Adjust the volume as desired while playing the keyboard.

3 Press and hold the [⏻] (Standby/On) switch for about a second to turn the power off.

⚠ WARNING

- Even when the power is turned off, electricity is still flowing to this instrument in a small amount. Remove the electric plug from the outlet when the instrument is not to be used for extended periods of time or during electrical storms.

NOTICE

- Press only the [⏻] (Standby/On) switch when turning the power on. Any other operations such as pressing keyboards/ buttons or stepping on the foot switch may cause the instrument to malfunction.

NOTE

- For details on settings that are not erased even when the power is turned off, see “Backup Parameters” (page 35).

Auto Power Off Function

To prevent unnecessary power consumption, this instrument features an Auto Power Off function that automatically turns the power off if the instrument is not operated for approximately 30 minutes by default; however, you can change this setting.

■ To set the time that elapses before Auto Power Off is executed

Press [FUNCTION] **16** repeatedly until “AutoOff” (page 34, Function number 028) appears. Then, press [+] or [-] **15** to change the time until the power turns off. Settings: oFF (off), 5, 10, 15, 30, 60, 120 (minutes) Default value: 30 (minutes)

■ To easily disable the Auto Power Off function

To turn on the power, hold down the leftmost key and press the [⏻] (Standby/On) switch. The message “oFF AutoOff” will appear briefly, and then the instrument will start up with the Auto Power Off function disabled.



NOTICE

- Depending on the instrument status, the power may not turn off automatically, even after the elapse of the specified period of time. Always turn off the power manually when the instrument is not in use.
- When the instrument is not operated for a specified period of time while connected to an external device such as an amplifier, speaker, or computer, make sure to follow the instructions in the Reference Manual to turn off the power to the instrument and the connected devices in order to protect the devices from damage. If you do not want the power to turn off automatically when a device is connected, disable Auto Power Off.

NOTE

- When the power is turned off using the Auto Power Off function, the previous panel settings are automatically backed up. For details on the items that are backed up, see “Backup Parameters” (page 35).

Adjusting the Master Volume

To adjust the volume of all keyboard sounds, use the [MASTER VOLUME] dial while playing the keyboard.

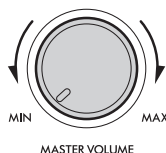

CAUTION

- Do not use the instrument for a long period of time at a high or uncomfortable volume level, since this can cause permanent hearing loss.

Connecting Headphones or External Speakers

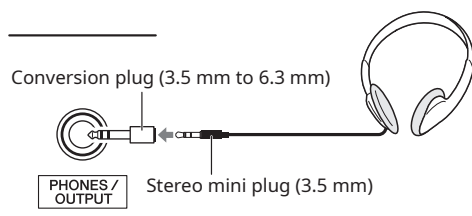

* This is an illustration of the connection when using Yamaha headphones (sold separately).

Connect a pair of headphones to the [PHONES/OUTPUT] jack. This jack also functions as an external output. By connecting to a speaker with a built-in amplifier, computer, keyboard amplifier, recorder, or other audio device, you can output audio signals from this instrument to the external device. The speakers of the instrument are automatically shut off when a plug is inserted into this jack.

CAUTION

- Do not use the instrument or headphones for a long period of time at a high or uncomfortable volume level, since this can cause permanent hearing loss.
- Before connecting the instrument to other external devices, turn off the power of all the devices. Also, before turning any devices on or off, make sure to set all volume levels to the minimum. Otherwise, damage to the devices or electrical shock may occur.

NOTICE

- To avoid possible damage to the external device, first turn on the power to the instrument and then to the external device. When turning off the power, do so in the reverse order: first turn off the power to the external device and then to the instrument.

Using a Pedal (Sustain)

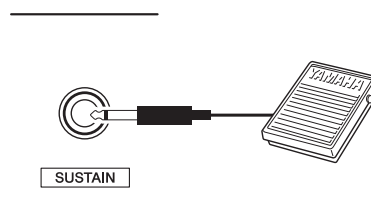

By connecting a foot switch (FC5 or FC4A; sold separately) to the [SUSTAIN] jack, you can make the sound continue to resonate for a long time even if you take your fingers off the keyboard while you press the foot switch, similar to a damper pedal on a piano.

NOTE

- Plug or unplug the foot switch while the power is turned off.
- Do not press the foot switch when turning the power on. Doing so changes the polarity of the foot switch, resulting in reversed operation.
- The sustain function does not affect Styles (automatic accompaniment; page 23).

Using the Music Rest

Insert the music rest into the slots as shown.

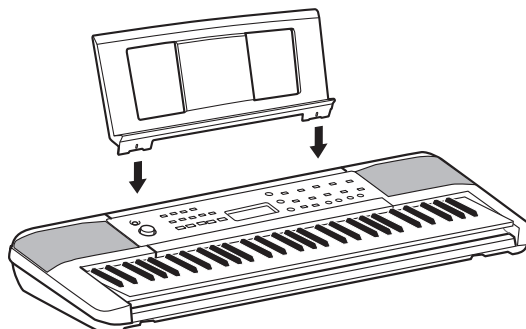

Panel Controls and Terminals

■ Front Panel

About the alternate button names enclosed in frames (SHIFT function)
 If you operate one of the buttons while holding down **[SHIFT]** 19, the function indicated in the frame below the button will be executed.
 For example, holding down **[SHIFT]** 19 and pressing **[METRONOME]** 4 calls up the Time Signature setting display.

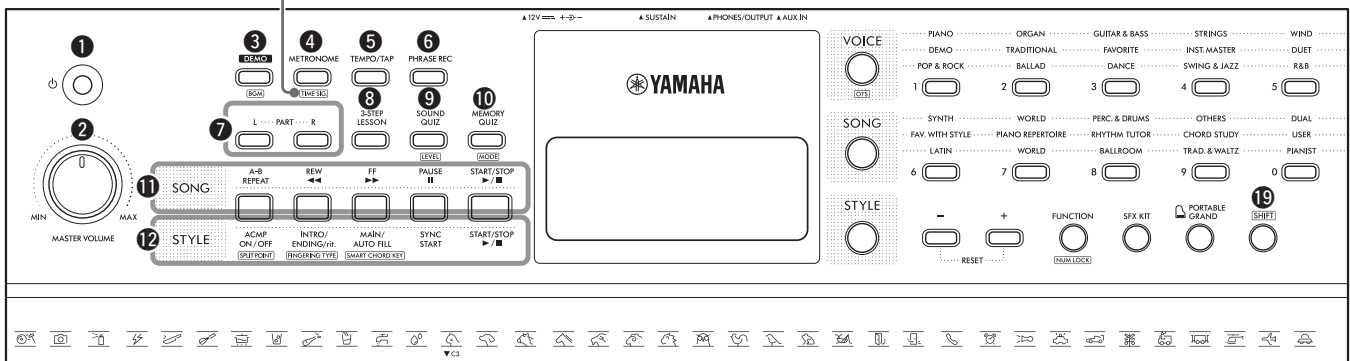

- | | |
|---|---|
| <p>1 [POWER] (Standby/On) switch..... page 6
Switches between standby and power on.</p> <p>2 [MASTER VOLUME] dial..... page 7
Adjusts the overall volume.</p> <p>3 [DEMO] button page 18
Starts/stops continuous Demo Song playback.
[BGM]
Sets the Song group (Demo Group) for continuous playback (page 19).</p> <p>4 [METRONOME] button..... page 15
Starts/stops the metronome.
[TIME SIG.]
Sets the time signature of the metronome (page 15).</p> <p>5 [TEMPO/TAP] button..... page 15
Sets the tempo of the Song/Style/metronome.</p> <p>6 [PHRASE REC] button page 29
Records your performance.</p> | <p>7 [PART] ... [L]/[R] buttons page 20
Selects a lesson part or a muted part of the current Song.</p> <p>8 [3-STEP LESSON] button page 21
Starts/stops the 3-step Lesson. Also used for selecting the mode of the Lesson.</p> <p>9 [SOUND QUIZ] button page 28
Starts/stops the Sound Quiz.
[LEVEL]
Selects the level of the Sound Quiz (page 28).</p> <p>10 [MEMORY QUIZ] button page 28
Starts/stops the Memory Quiz.
[MODE]
Selects the type (mode) of the Memory Quiz (page 28).</p> <p>11 Song control buttons page 18
Controls Song playback.</p> <p>12 Style control buttons page 23
Controls Style playback.</p> |
|---|---|

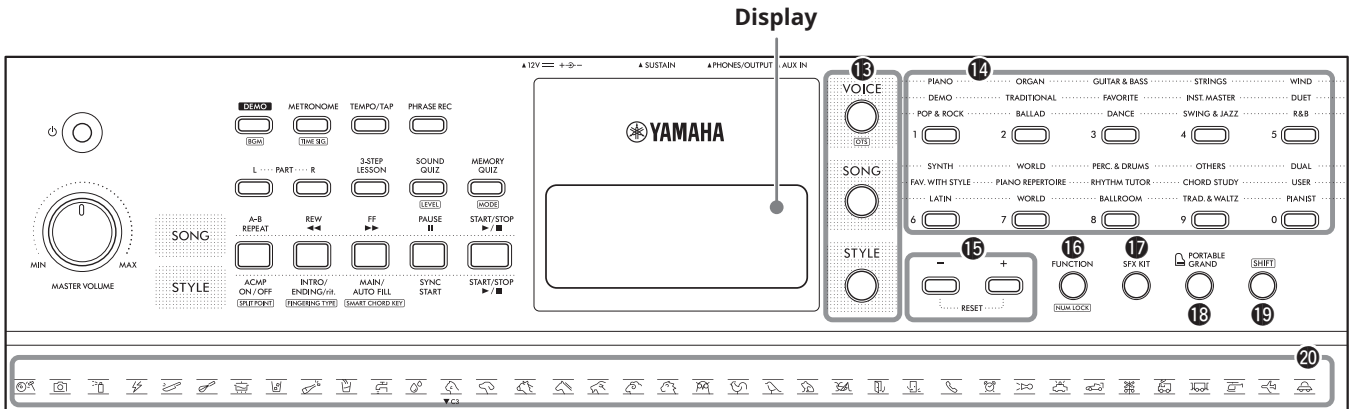

- 13 Mode selection buttons page 10**
Calls up the corresponding selection displays for Voices, Songs, and Styles, and switches to each mode.
OTS (One Touch Setting)
Automatically calls up the best Voice for the selected Song or Style (page 14). When One Touch Setting is enabled, the Voice number becomes "000."
- 14 VOICE/SONG/STYLE Category buttons, Number buttons [0]–[9] page 14, 18, 23**
Selects the desired Voice/Song/Style or allows direct entering of setting values, etc.
- 15 [+]/[-] buttons**
Selects items or sets values. Press and hold either button to continuously increase or decrease the value in the corresponding direction. Press these buttons simultaneously to reset the value to the default.
- 16 [FUNCTION] button page 32**
Calls up the Function setting display.
NUM LOCK
Calls up the **NUM LOCK** icon on the display and lets you use the 14 buttons as Number buttons.
- 17 [SFX KIT] button page 14**
Lets you play various sound effects from the keyboard.
- 18 [PORTABLE GRAND] button page 14**
Automatically selects "Grand Piano" with Voice Number 001 as the Voice.
- 19 [SHIFT] button**
Holding down this button and pressing another button calls up the alternate function of that button.
- 20 SFX Kit illustrations page 14**
These indicate the sound effects assigned to each key when the SFX Kit is selected by pressing [SFX KIT] 17.

■ Rear Panel

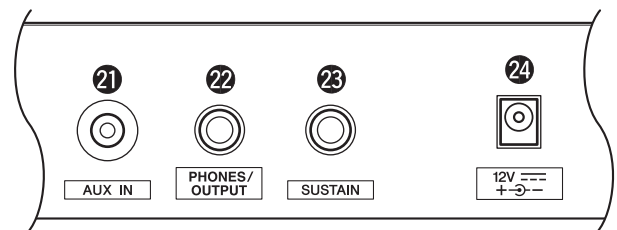

- 21 [AUX IN] jack page 31**
For connecting an audio device such as a smartphone.
- 22 [PHONES/OUTPUT] jack page 7**
For connecting external devices such as headphones and speakers (sold separately).
- 23 [SUSTAIN] jack page 7**
For connecting an optional foot switch and using it as a sustain pedal.
- 24 DC IN jack page 5**
For connecting the AC adaptor.

Basic Operations and Display Items

Basic Operations

This instrument features three basic functions: Voice, Style, and Song. To use the instrument, select a basic function first, and then select the desired data to use for your performance.

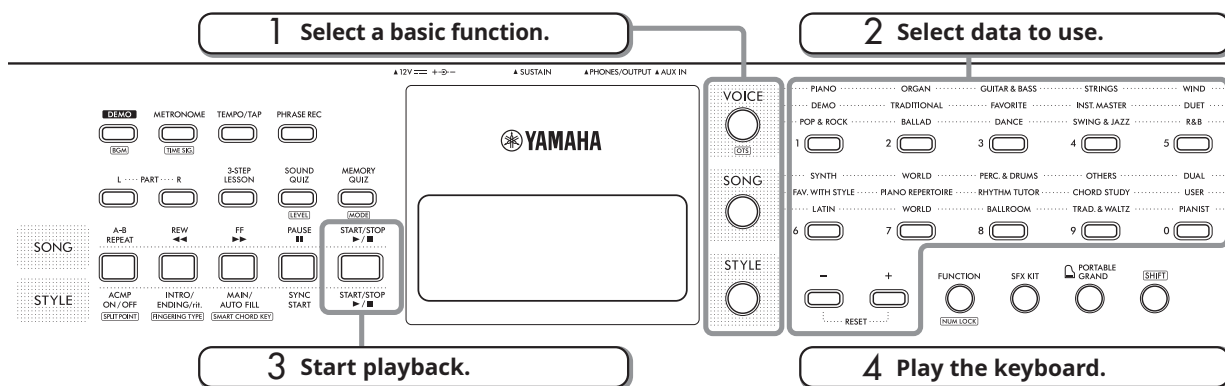

- 1 Select the desired function by pressing [VOICE], [SONG], or [STYLE] ⑬.
- When you select a basic function, the current setting value for the selected function is shown on the display. Also, ▶ is displayed next to the currently selected mode, indicating the mode of the content shown on the display.

NOTE

- Only one of the Songs or Styles can be used.

- 2 Select the desired data.

Data can be selected by one of the following methods.

- By selecting a category
- By inputting the number directly
- By pressing [+] or [-] ⑮

For details on each operation, see “How to select Voices, Songs, or Styles” on the right.

- 3 Press [START/STOP] ⑭.
- The Song or Style will start playing.

NOTE

- Press [START/STOP] ⑭ again to stop playback.

- 4 Play the keyboard with the selected Voice.

NOTE

- You can also use the One Touch Setting (OTS) function (page 14) to call up the optimum panel settings (Voice, etc.) for the selected Song or Style.

How to select Voices, Songs, or Styles

Selecting with the Category buttons ⑭

The top of the panel display is the VOICE category, the middle is the SONG category, and the bottom is the STYLE category.

Each time you press the button, the items change in numerical order within that category.

- ORGAN ← VOICE category
- TRADITIONAL ← SONG category
- BALLAD ← STYLE category



Selecting by entering numbers (NUM LOCK)

Enter the data number directly. For data numbers, see the Voice List, Song List, and Style List (pages 38–46) at the end of the document.

- 1 Hold down [SHIFT] ⑰ and press [FUNCTION] ⑱.

The NUM LOCK icon will appear on the display, and the Category buttons ⑭ can then be used as Number buttons.



- 2 Press the number of your desired Voice, Song, or Style.

- 3 To stop entering numbers, hold down [SHIFT] ⑰ and press [FUNCTION] ⑱ again.

NOTE

- If you keep pressing [+] or [-] ⑮, the numbers will change continuously. Press [+] and [-] ⑮ at the same time to return to the initial settings.

Selecting with [+] or [-] ⑮

Press [+] to select the next Voice, Song, or Style, and press [-] to select the previous Voice, Song, or Style.

Display Items

Each icon appears on the display when the respective function is turned on.

- L R** Part (page 20)
- A=B** A-B Repeat (page 20)
- ACMP** Style (page 13, 23, 27)
- SMART** Smart Chord Key (page 25)
- MULTI** Multi-Finger (page 25)

- DUAL** Appears when you select a Voice in the "DUAL" category (Voice numbers 396–410).
- WIDE** Ultra-Wide Stereo (page 15)
- DUO** Duo Mode (page 17)

NUM LOCK While this icon appears on the display, the VOICE/SONG/STYLE Category buttons **1-9** can be used as Number buttons.

- ▶ VOICE** Voice selection mode
- ▶ SONG** Song mode
- ▶ STYLE** Style mode

* The ▶ mark next to the mode name indicates the mode that is active and whose contents can be selected with the Category buttons **1-9**.

* **▶ VOICE** always appears on the display.

DUAL
WIDE
DUO
L R
A=B
ACMP
SMART
MULTI

NUM LOCK **GrandPro** **▶ VOICE**
▶ SONG
▶ STYLE

C **FUNCTION** **MEASURE** **BEAT** **✔** **✘** **AUTO**
J=003 **00 1/0 1** **3/1** **TRY123** **Lv123**

C3

Indicates the chord played in the Auto Accompaniment range (page 23) of the keyboard or the chords included in the currently playing Song.

Indicates the tempo (page 15) and function number (page 32).

Indicates information about the Sound Quiz (page 28).

- ✔ Number of correct answers
- ✘ Number of incorrect answers

* After the 10th question, ✔ and ✘ will disappear, and only the number of correct answers will be displayed.

TRY123 Number of times you answered the same question

AUTO
Lv123 Quiz level (difficulty)

Indicates notes currently being played. The correct notes for sound quizzes, Song melodies during lessons, chord composition notes for automatic accompaniment, etc. are displayed.

Indicates the current measure number and number of beats in the current Song or Style.

Playing a Song

Try using the convenient functions of this instrument to play Song number 4, "Frère Jacques."

Song No. 004
Tempo ♩ = 94

Frère Jacques

Melody Voice
Celesta

 : Smart Chord

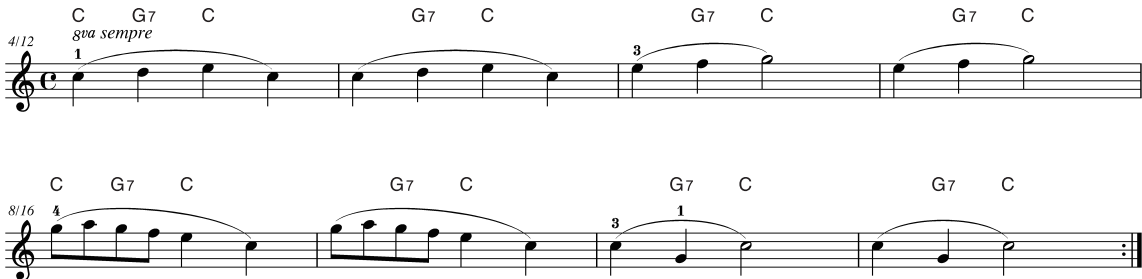



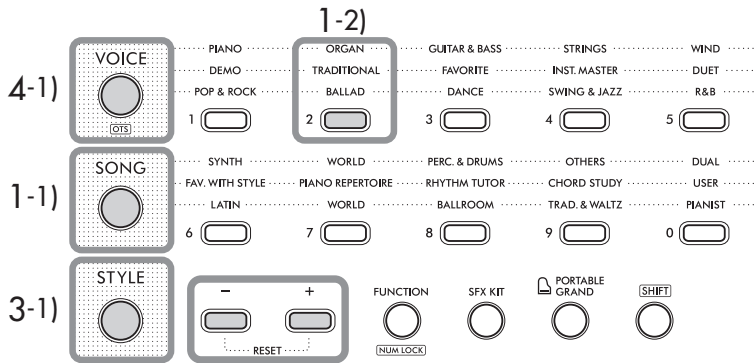

The same chord will sound, no matter which key you play.



Song Playback (page 18)

1 Listen to the sample lesson (Song).

- 1) Press [SONG] .
- 2) Press [TRADITIONAL] in the Category buttons  and select "004 FrereJac" (Frère Jacques), which should be displayed first.
If a different Song is displayed, press [TRADITIONAL] in the Category buttons  repeatedly or use [+] or [-]  to select "004 FrereJac."



3) Press [START/STOP] to listen to the Song.

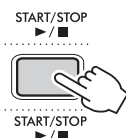

4) Press [START/STOP] again to stop Song playback.

3-Step Lesson (page 21)

2 Try playing with your right hand using the Lesson function.

- 1) Press [3-STEP LESSON]  three times and select "3 WAITING" (Lesson 3—Your own pace).



Song playback will wait until you play the correct key.

- 2) Play slowly at your own pace while looking at the musical score and the keyboard on the display.



Press [START/STOP]  to end the Lesson.

Playing with a Style (page 23)

3 Try playing the automatic accompaniment with your left hand.

- 1) Press [STYLE] 13.
- 2) Press [TRAD. & WALTZ] 14 repeatedly to select "134 Showtune."

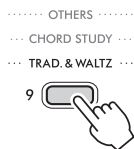

- 3) After pressing [TEMPO/TAP] 5, use [+] or [-] 15 to set the tempo to "94."



- 4) Press [START/STOP] 12 to check the Style.

NOTE

- The Style will be a little different from what you heard in the sample lesson.

- 5) Press [STYLE] 13, and then press [ACMP ON/OFF] 12 to turn on the automatic accompaniment.

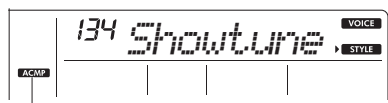

ACMP Displayed when Style (Auto Accompaniment) is turned on.

With this operation, the F#2 key becomes the boundary (split point), and the keys to the left of this become the "Auto Accompaniment range" for chord recognition.

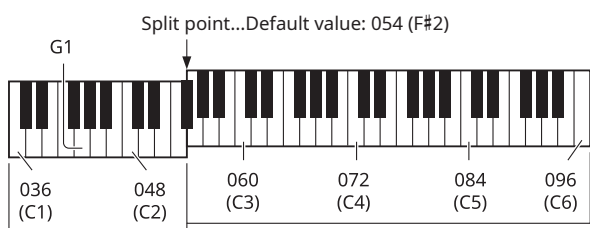

Auto Accompaniment range

- 6) Press [START/STOP] 12 to start rhythm playback, and then play the C2 key.
The Style will start playing. If you play the C2 key, a C (major) chord will sound. (The same chord will sound if you play the C1 key.)
- 7) Play the G1 key. This time, the G7 chord will sound. The chord will change according to the key you play, so feel free to play the keys in the Auto Accompaniment range.
- 8) Press [START/STOP] 12 to stop playback.

4 Select the Voice of the melody.

- 1) Press [VOICE] 13.
- 2) Hold down [SHIFT] 19 and press [FUNCTION] 16.
The NUM LOCK icon will appear on the display.
- 3) Enter "291" using the Number buttons 14 to select "Celesta."



- 4) Play the keyboard to check the Voice.

5 Try playing with both hands.

- 1) Press [START/STOP] 12 to start rhythm playback, and then play the C2 key to start Style playback.
While looking at the musical score, try playing the melody with your right hand, following the chords with your left hand.
- 2) If the tempo is too fast, press [TEMPO/TAP] 5 and then adjust with [+] or [-] 15.
Press [+] and [-] 15 at the same time to return to the default tempo.
- 3) When the performance is finished, press [INTRO/ENDING/rit.] 12.
An ending will be added, and the Song will end automatically.

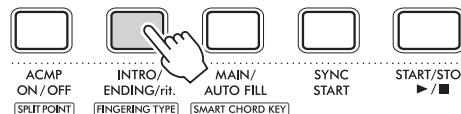

Recording your performance (page 29)

6 Record your own performance.

- 1) Press [PHRASE REC] 6.
Recording will start.



- 2) To end recording, press [PHRASE REC] 6 again.
If you press [INTRO/ENDING/rit.] 12, recording will automatically end when the added ending finishes playing.

Select a Voice and Play!

With this instrument, you can change the sound of the keyboard to the sound of an instrument other than the piano.

Selecting a Voice

- 1 Press [VOICE] ⑬.



- 2 Press the button of the desired Voice from among the Category buttons ⑭.

..... ORGAN ← VOICE category
..... TRADITIONAL
..... BALLAD



Each time you press the button, it changes to a different Voice within the same category.

- 3 Play the keyboard.

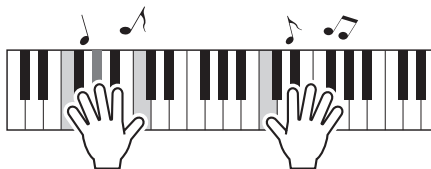

NOTE

- There are two other ways to select a Voice. See “How to select Voices, Songs, or Styles” (page 10).

Drum Kit

The Drum Kit is a collection of various percussion instrument sounds. If you select a drum kit (Voice numbers 125–133 and 387–395) as the Voice, each key played will produce a different percussion instrument sound.

For details on the instruments and key assignments of each Drum Kit, see “Drum Kit List” (page 42).

Selecting the Best Voice for the Song or Style (One Touch Setting)

The One Touch Setting feature automatically selects the most suitable Voice when you select a Song or Style (excluding songs input from the [AUX IN] jack). You can activate the One Touch Setting by holding down [SHIFT] ⑮ and pressing [VOICE] ⑬. You can also activate it by selecting Voice number “000” for the Voice. If you select another Voice, the One Touch Setting will be canceled.

Playing Various Sound Effects

- 1 Press [SFX KIT] ⑰.



- 2 Play the keyboard.

A sound effect plays, one that corresponds to the SFX kit illustration ⑱ just above the key you played.



Even if you play a key that does not have an illustration above it, various sounds will be produced.

For the sound effects assigned to each key, see “SFX Kit List” (page 41).

Calling up the Grand Piano Voice

- 1 Press [PORTABLE GRAND] ⑱.



This instantly resets all of your settings, and lets you play the piano sound with the entire keyboard.

Using the Metronome

This instrument features a built-in metronome (a device that keeps an accurate tempo), convenient for practicing piano songs.

- 1 Press [METRONOME] ④.



The metronome click sound starts.

- 2 Press [METRONOME] ④ again to stop.

To set the Time Signature

Hold down [SHIFT] ⑲ and press [METRONOME] ④ to call up "TimeSig" (page 33, Function number 021). Then, press the Number buttons ⑭ or [+] or [-] ⑮ to set the time signature.

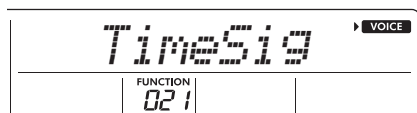

The first beat sounds with a bell (for an accent), and the other beats sound with clicks. If the time signature is set to 00, all beats sound with clicks and no bell accent.

To set the Metronome Volume

Set in "Function Settings" (page 33, Function number 022).

Adjusting the Tempo

You can change the metronome, Style, and Song tempo. Press [TEMPO/TAP] ⑤ to call up "Tempo" on the display.

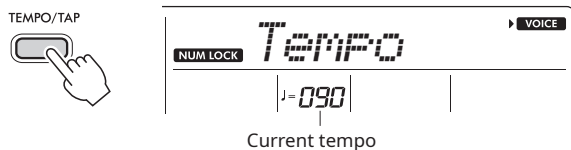

When setting the tempo, the **NUM LOCK** icon will appear on the display, and you can directly enter the tempo using the Category buttons ⑭ as Number buttons. Set the tempo using the Number buttons ⑭ or [+] or [-] ⑮. Press [+] and [-] ⑮ at the same time to return to the default tempo of the current Song or Style.

Using the Tap function

The Song or Style will start at the tempo with which you tap [TEMPO/TAP] ⑤. Tap this button 4 times for 4 beats or 3 times for 3 beats.

While a Song or Style is playing, tapping twice will change the tempo.



Playing with Enhanced, More Spacious Sound (Ultra-Wide Stereo)

The Ultra-Wide Stereo effect provides a more spacious and wider presence for the overall keyboard sound, giving the sensation of hearing the sound outside of the speakers.

- 1 Press [FUNCTION] ⑩ repeatedly to call up "Wide (018)."

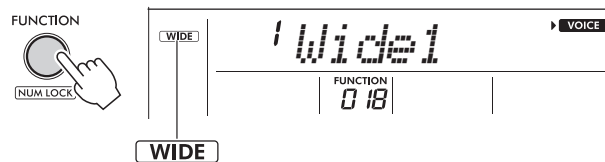

Displayed when Ultra-Wide Stereo is turned on.

- 2 Press [+] or [-] ⑮ to select the level.

There are three levels of the Ultra-Wide Stereo effect: 1-3. The higher the number, the greater the effect.

- 3 Press [+] or [-] ⑮ and select "4" (Wide Off) to turn off Ultra-Wide Stereo.

Applying Effects to the Sound

This instrument features a variety of Effects (listed below) for enhancing the overall sound.

● Reverb

Adds the ambience of a club or concert hall to the sound. Although the best-suited Reverb type will be automatically called up by selecting a Song or Style, you can select another one in "Function Settings" (page 33, Function number 013). You can also set the Reverb level (page 32, Function number 006) in "Function Settings."

● Chorus

Makes the Voice sound richer, warmer, and more spacious. Although the best-suited Chorus type will be automatically called up by selecting a Song or Style, you can select another one in "Function Settings" (page 33, Function number 015). You can also set the Chorus depth (page 32, Function number 007) in "Function Settings."

NOTE

- For some Voices, Chorus is enabled but the Chorus depth (or level) is set to 000, so no effect is applied. If you want to add a Chorus effect, try increasing the Chorus level.

● Panel Sustain

By turning on the Sustain parameter (page 33, Function number 016) in "Function Settings," you can apply a fixed, automatic sustain to the keyboard Voices. A sustain effect can also be applied selectively using a separately sold foot switch (page 7).

NOTE

- Even when Panel Sustain is turned on, there are some Voices to which sustain is not applied and some Voices that produce unintended sounds.

Playing the Keyboard with Two People (Duo Mode)

When the Duo mode is turned on, the keyboard is divided into left and right player sides, allowing two people to play in the same octave range at the same time. This is useful for learning situations, in which one person (a teacher, for example) plays a model performance and the other person watches and practices while sitting at the first person's side.

- 1 Press [FUNCTION] **F** repeatedly to call up "DuoMode (024)."

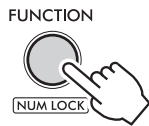

- 2 Press [+] **F** to turn it to "on."

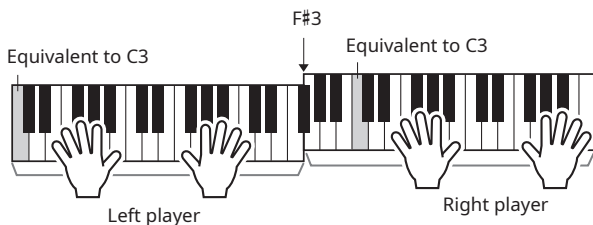
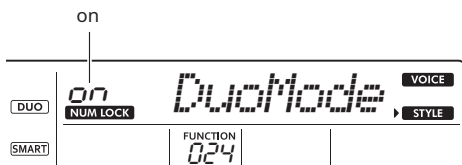

The keyboard is divided into left and right sections with the F#3 key as a boundary, and you can play the same range of notes on the left and right.

NOTE

- The left and right player sides of the keyboard are both set to the same Voice. However, this does not apply if you select a Voice from the "DUAL" category (Voice numbers 396–410).
- The boundary between the left and right players' keys cannot be changed from F#3.

- 3 Play with two people, one on the left player side and one on the right player side.

Selecting a Voice

Select a Voice by executing Steps 1 and 2 in "Selecting a Voice" on page 14.

NOTE

- If you select a Voice from the "DUAL" category (Voice numbers 396–410), only the right player's side will have a sound that is a combination of two sounds (dual).
- The Lesson function cannot be used in the Duo mode.

How sounds are output in the Duo mode

Notes played on the left player side sound from the left-side speaker, while notes played on the right player side sound from the right-side speaker in the initial Duo mode setting. You can change the way the speakers sound by following the steps below.

- 1) Call up "DuoType" (page 33, Function number 025) in "Function Settings."
- 2) Select the output method for the left and right speakers by selecting either "1 Balance" or "2 Separate."
 - **Balance:** The performance sounds on the left player side and right player side will sound from both the left and right speakers.
 - **Separate:** The performance sounds on the left player side will sound from the left speaker, and the performance sounds on the right player side will sound from the right speaker.

The default setting in the Duo mode is "2 Separate."

NOTE

- If "DuoType" is "2 Separate," the pan, volume, and tonal characteristics of the stereo sound may differ from normal. Particularly with Drum Kits, the difference may be more obvious, since each key of a Drum Kit features a different stereo pan position.

Sustain effect in the Duo mode

As with the conventional mode, the Duo mode lets you apply a lingering sound (sustain effect) to the keyboard performance using either of the methods below. With either method, you can apply a sustain effect to both the left and right player's keyboard sounds.

- Press the foot switch (page 7) connected to the [SUSTAIN] jack.
- If you want the sustain effect to always be applied, set "Sustain" (page 33, Function number 016) to "on" in "Function Settings."

NOTE

- Sustain effects cannot be applied separately to the sound on the left and right player sides.

Style Playback in the Duo mode

Only the rhythm part of a Style can be played back. Other parts cannot be played back.

Phrase recording in the Duo mode

The sounds played on the left and right player sides are recorded to the same track.

For details on phrase recording, see "Recording Your Performance (Phrase Recording)" (page 29).

- 4 To cancel the Duo mode, call up "DuoMode (024)" (see Step 1) and press [-] **F** to set it to "off (off)."

Select a Song and Listen!

The term “Song” on this instrument refers to both a “complete piece of music” but also the data it contains. This means that the preset Songs of this instrument are not only fun to listen to, but can also be used in conjunction with other features of the instrument, such as the Lesson function.

Selecting and Playing a Preset Song

1 Press [SONG] ⑬.



2 Press one of the Category buttons ⑭ to select the desired Song.

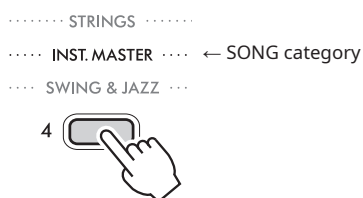

Each time you press the button, it changes to a different Song within the same category.

3 Press [START/STOP] ⑩ to play the Song.

- You can change the tempo by pressing [TEMPO/TAP] ⑤ (page 15).
- To practice a part, press [L] or [R] of [PART] ⑦ to mute the sound of that part (page 20).

4 Press [START/STOP] ⑩ to stop Song playback.

After a Song finishes playing, the playback will stop automatically.

NOTE

- There are two other ways to select a Song. See “How to select Voices, Songs, or Styles” (page 10).

Adjusting the Song Volume

By adjusting the Song volume, you can adjust the balance between your keyboard performance and Song playback. Adjust Song volume (page 33, Function number 011) in “Function Settings.” For preset Songs and Song numbers, see “Song List” (page 45).

Listening to a Demo Song

Three original Demo Songs that take advantage of the features of this instrument are included.

1 Press [DEMO] ③.



After Song numbers 001 to 003 are played back in sequence and the last Song (003) is finished, playback repeats continuously, starting again from the first Song (001).

To stop playback, press [DEMO] ③ again.

You can also stop playback by pressing [START/STOP] ⑩.

NOTE

- You can select the next or previous Song in order by using [+] or [-] ⑤ after pressing [DEMO] ③. The selection range is all Songs in the selected Demo Group (page 34, Function number 026).

Playing Songs Continuously (Background Music Function)

With the default setting, pressing [DEMO] ③ will play back only the three internal Demo Songs repeatedly. However, this setting can be changed so that, for example, all internal Songs automatically play back (Continuous playback), letting you use the instrument as a background music source.

1 Hold down [SHIFT] ⑱ and press [DEMO] ③.

“DemoGrp” (page 34, Function number 026) is shown on the display for a few seconds, followed by the current repeat playback target (Demo Group).

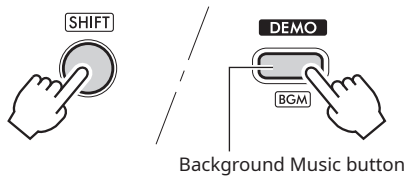

2 Press [+] or [-] ⑮ to select one of the groups below that you want to play continuously.

Demo	Preset Songs (001–003)
Preset	All preset Songs (001–100)
User	User Song (123) (page 29)

3 Press [DEMO] ③.

The Songs in the selected group will be played continuously. To stop playback, press [DEMO] ③ again. You can also stop playback by pressing [START/STOP] ①.

Random Song Playback

When the Demo Group is set to “Preset,” the playback order in [DEMO] ③ can be changed between numerical and random order. To do this, press [FUNCTION] ⑯ repeatedly until “PlayMode (027)” is called up, and then select “Normal” or “Random.”

Song Fast Forward, Fast Reverse, and Pause

Like the transport controls on an audio player, this instrument lets you fast forward (FF), rewind (REW), and pause (PAUSE) playback of a Song.

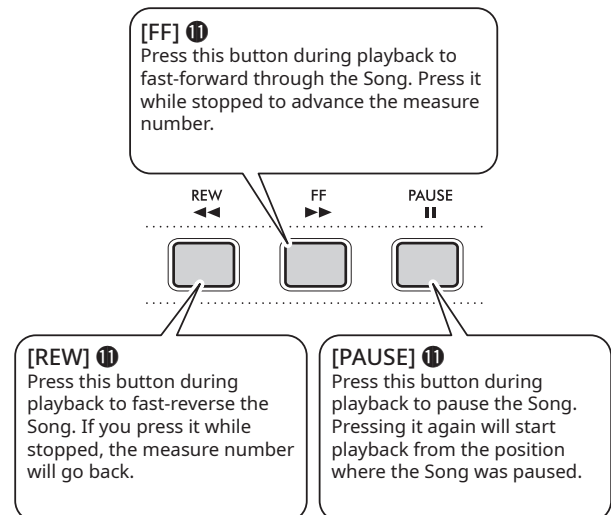

NOTE

- When A-B repeat (page 20) is specified, Fast Reverse and Fast Forward only work within the range between A and B.
- [REW], [FF], and [PAUSE] ① cannot be used during Song playback using [DEMO] ③.

Changing the Melody Voice of a Preset Song

You can change a Preset Song’s melody Voice to any other desired Voice.

- 1 Select a Song and play it (page 18).
- 2 Select the desired Voice (page 14).
- 3 Press [FUNCTION] ⑯ repeatedly until “MelodyVc(012)” appears.
- 4 Press [+] ⑮.

“SONG MELODY VOICE” will appear on the display for a few seconds, and the Song’s melody Voice will change to the Voice you selected in Step 2.

NOTE

- Selecting another Song will cancel the changed Melody Voice.
- You cannot change the melody Voice of a User Song.

Listening to Part of a Song Repeatedly (A-B Repeat)

This function is especially useful for practicing, and lets you repeatedly play back only a specific section of a Song by setting the A point (start point) and B point (end point) in one-measure increments.

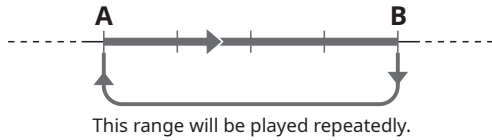

- 1 Start playback of the Song (page 18).
- 2 When playback reaches the point you want to specify as the start point, press [A-B REPEAT] **1** to set the A point.



- 3 When playback reaches the point you want to specify as the end point, press [A-B REPEAT] **1** again to set the B point.

The specified A-B section of the Song will now play repeatedly.

NOTE

- Even when the Song is stopped, you can use [FF] **1** and [REW] **1** to move to the measure you want to specify and set the A-B repeat range.
- If you want to set the start point "A" at the top of the Song, press [A-B REPEAT] **1** before starting playback.

- 4 To cancel repeat playback, press [A-B REPEAT] **1**.

To stop playback, press [START/STOP] **1**.

NOTE

- The A-B Repeat function is canceled when you select another Song.

Turning Each Part On/Off

A Song consists of two parts. Each part can be turned on/off individually by pressing the appropriate button ([L] or [R]) of [PART] **7** while the Song is playing.

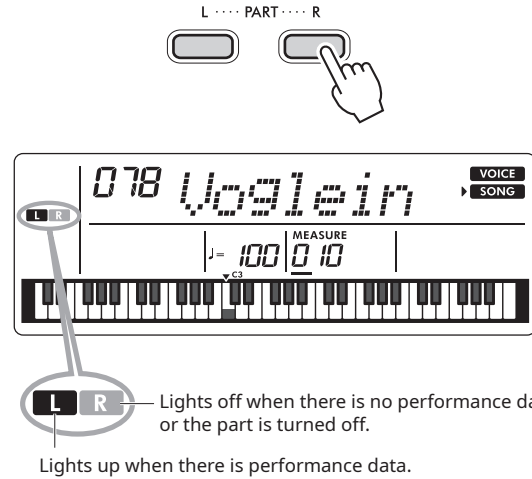

By turning the left- and right-hand parts on or off during playback, you can listen to the part (that is turned on) while practicing the other part (that is turned off) on the keyboard.

NOTE

- Selecting another Song will reset the on/off status of the Parts.

Using the Song Lesson Feature

You can use the selected Song for a left-hand, right-hand, or both-hands Lesson. Try practicing with three Song Lesson types while referring to the music scores in the Song Book (page 2).

Listening, Timing, and Waiting

● Lesson 1—Listening to a model performance (LISTEN)

In this Lesson, you do not need to play the keyboard. The part you selected will sound as a model. Listen to the Song carefully and remember it well.

● Lesson 2—Key play timing (TIMING)

In this Lesson, simply concentrate on playing the keys with the correct timing. Even if you play the wrong notes, the correct notes shown on the display will sound.

● Lesson 3—Your own pace (WAITING)

In this Lesson, try playing the correct notes shown on the display. Song playback will wait until you play the correct key. The Song playback tempo changes to match the pace of the player, so you can practice at your own pace.

NOTE

- If you want to keep the playback tempo constant during "Lesson 3—Your own pace (WAITING)," set the function (page 33, Function number 023) to "oFF (off)" in "Function Settings."

Practicing with a Song Lesson

1 Press [SONG] **8**, and then select a Song for your Lesson.

2 Press either or both [R] and [L] of [PART] **7** to select the part you want to practice.

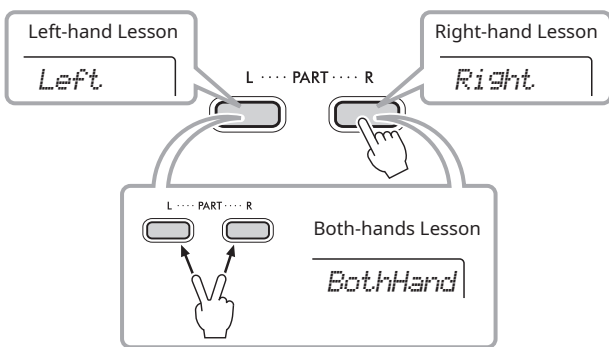

If you select Song numbers 057–077 (SONG category: FAVORITE WITH STYLE), you can practice playing chords using Styles with your left hand. During left-handed and both-handed lessons, the left side of the keyboard becomes the Auto Accompaniment range, so when you play a chord with your left hand, the Style will sound.

NOTE

- If "No LPart" is displayed in Step 2, the selected Song does not include a left-hand part.

3 Press [3-STEP LESSON] **8** to play the Lesson song.

Press [3-STEP LESSON] **8** repeatedly to select the Lesson type. Each time you press the button, the settings will change in the order of "1 LISTEN," "2 TIMING," "3 WAITING," Off, and return to "1 LISTEN."



Let's start the Lesson.

NOTE

- Even during a Lesson, you can press [3-STEP LESSON] **8** to switch between "1 LISTEN," "2 TIMING," and "3 WAITING." You can also stop the Lesson by pressing [START/STOP] **1**.
- The Voice changes to "000" (One Touch Setting; page 14) during the Lesson.

4 When Lesson playback reaches the end, your evaluation Grade will appear on the display ("2 TIMING" and "3 WAITING" only).

Either "Excellent!," "Very Good!," "Good," or "OK" will appear on the display.



After the evaluation display has appeared, the Lesson will start again from the beginning.

NOTE

- When the melody Voice of the Song is changed (page 19), the key position shown on the display may be shifted (in octave units) depending on the selected Voice.

5 If you want to stop Song playback and end the Lesson, press [START/STOP] **1**.

Hearing and Experiencing the Sounds of the Chords (Chord Study)

You can hear and experience the actual sounds of the chords required for performance by playing back Song numbers 111–122 (in the SONG category “CHORD STUDY”). Song numbers 111–117 are Songs consisting of a single chord (C, Dm, Em, F, G, Am, and Bm, respectively), letting you listen to and master the chords one by one. On the other hand, Song numbers 118–122 consist of several chords strung together in a pattern, for experiencing and understanding basic chord progressions. Hear and experience the sounds of simple chords and progressions by playing back these Songs, and play the keyboard while following along with the music notation and key/chord indications shown on the display.

Hearing and Experiencing the Sound of a Single Chord

- 1 Press [SONG] .



- 2 Press [CHORD STUDY]  repeatedly to select a Song from Song numbers 111–117.



- 3 Press [START/STOP]  to start playing the selected Song.

- 4 Play the keyboard while looking at the notes shown on the display.

Experience the sound of each chord one by one.

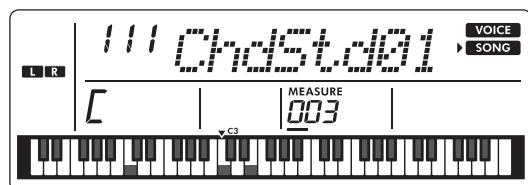



NOTICE

- When playing the keyboard while playing back a Song, you should turn off the part you are playing (page 20) to avoid exceeding the maximum number of notes that can be played simultaneously. For details on polyphony, see “Maximum Polyphony” (page 38).

NOTE

- You can use the function of “Lesson 3—Your own pace (WAITING)” (page 21) by pressing [3-STEP LESSON] .

Hearing and Experiencing Basic Chord Progressions

- 1 Select a Song from Song numbers 118–122 in the SONG category “CHORD STUDY” by pressing [+] or [-] .
- 2 Press [START/STOP]  to start playing the selected Song.
- 3 Play the keyboard while looking at the notes shown on the display.

Listen to the basic chord progression, and play along with the Song repeatedly until you can smoothly perform and play along with the chord changes.

NOTE

- You can use the function of “Lesson 3—Your own pace (WAITING)” (page 21) by pressing [3-STEP LESSON] .

Playing Along with Rhythm and Auto Accompaniment (Styles)

This instrument has an automatic accompaniment feature that automatically plays a chord Style (rhythm + bass note + chord note) that matches the root note or chord played with your left hand. You can select between two ways to play chords: "Smart Chord," in which you play the chord with one finger on the keyboard, and "Multi-Finger," in which you play the notes that make up the chord as they are. Let's try playing using this Auto Accompaniment function.

Playing Along with Auto Accompaniment (Styles)

The default setting for how to play chords is "Smart Chord (SmartChd)." For information on changing how to play the chord, see "Selecting How to Play a Chord (Fingering Type)" (page 25).

1 Press [STYLE] 13.



2 Press one of the Category buttons 14 to select the desired Style.



Each time you press the button, the Style changes to another Style in the same category. For the preset Styles and Style numbers, see "Style List" (page 46).

NOTE

- There are two other ways to select a Style. See "How to select Voices, Songs, or Styles" (page 10).

3 Press [ACMP ON/OFF] 12 to turn Auto Accompaniment on.

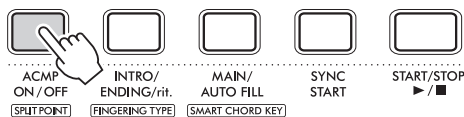

The **ACMP** icon will appear on the display. With this operation, the area to the left of the Split Point (054: F#2) becomes the "Auto Accompaniment range" and is used only for specifying chords.

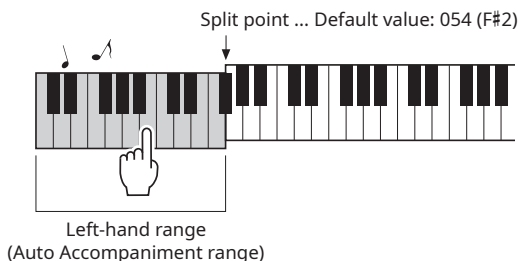

4 Press [SYNC START] 12.

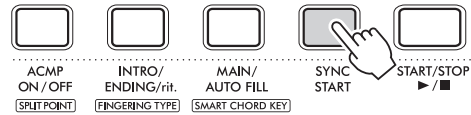

This enables the standby state for Auto Accompaniment, and the Style starts when you press a key in the left-hand range.

5 Play the root note of the accompaniment chords with your left hand, and play the melody with your right hand.

When the fingering type (page 25) is set to "Smart Chord (SmartChd)," press only the root note of the chord with your left hand. For details on how to play chords when using "Multi-Finger (Multi)," see "Chord Types for Style Playback" (page 26).

Try playing various chords with your left hand and melodies with your right hand.

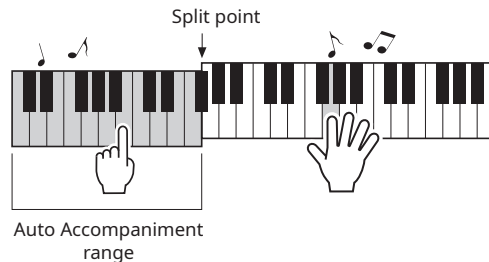

6 If you want to stop the Style and end the performance, press [START/STOP] 12.

Styles allow you to vary the performance by switching sections (accompaniment patterns). For details, see "Style Variations (Sections)" (page 24).

To change the split point

Hold down [SHIFT] 15 and press [ACMP ON/OFF] 12 to call up "SplitPnt" (page 32, Function number 003). Then, press [+] or [-] 15 to change the split point.

To play back the rhythm part only

If you press [START/STOP] 12 (without pressing [ACMP ON/OFF] 12 in step 3), only the rhythm part can be played back, and you will be able to play a melody performance using the entire keyboard range.

NOTE

- Since the Styles in the Style category "PIANIST" (143-150) have no rhythm parts, no sound is produced if you start rhythm-only playback. Sound is heard only when Auto Accompaniment (**ACMP**) is turned on and the keyboard in the left-hand range is played.

Style Variations (Sections)

Each Style consists of "Sections" that allow you to vary the arrangement of the accompaniment to match the song you are playing. These instructions cover a typical example for using the Sections.

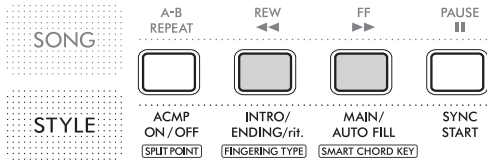

● Intro

Used when starting a performance. Once the Intro has finished playing, it will move on to the Main part. The number of bars in the Intro varies depending on the Style.

● Main

Used when playing the Main part of the Song. It will play repeatedly until you press another Style control button. There are two variations, A and B, and they are played according to the chord played with your left hand.

● Fill-in (Auto fill)

This is automatically inserted when Main A and B switch.

● Ending

Used at the end of a performance. At the same time as Ending playback ends, Style playback also ends. The number of bars in the Ending varies depending on the Style.

1 – 4

Same as Steps 1–4 in "Playing Along with Auto Accompaniment (Styles)" (page 23).

5 Press [MAIN/AUTO FILL] to select Main A or Main B.



The selected section ("MAIN A" or "MAIN B") will be displayed.

6 Press [INTRO/ENDING/rit.] .



Now, you are ready to start Style playback in the order of Intro and then Main A.

7 Play a chord in the Auto Accompaniment range to start playback of the Intro.

For this example, play a C major chord (as shown below). For information on how to enter chords, see "Chord Types for Style Playback" (page 26).

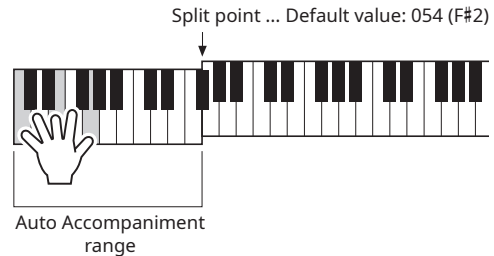

8 After the Intro finishes, play the keyboard according to the progression of the Song you are playing.

Play chords with your left hand while playing melodies with your right hand, and press [MAIN/AUTO FILL]  as necessary. The Section will change to Fill-in and then to Main A or B.



9 Press [INTRO/ENDING/rit.] .



The Section will switch to the Ending. When the Ending is finished, Style playback stops automatically. If you press [INTRO/ENDING/rit.]  again while the Ending is playing, the Ending will gradually slow down (ritardando), and Style playback will end.

Changing the Tempo

See "Adjusting the Tempo" (page 15).

Adjusting the Style Volume

By adjusting the Style volume, you can adjust the balance between your keyboard performance and Style playback. Set it in "Function Settings" (page 32, Function number 008).

Selecting How to Play a Chord (Fingering Type)

The playing method of a chord played in the Auto Accompaniment range during Style playback is called the fingering type and is set in the "Function Settings" (page 32, Function number 009). There are two available fingering types (below).

● Smart Chord (SmartChd) (Default setting)

This is a playing method that plays only the root note of the chord to produce automatic accompaniment.

● Multi-Finger (Multi)

This is a playing method in which the notes that make up the chord are played conventionally to produce automatic accompaniment. However, major, minor, seventh, and minor seventh can also be easily played by pressing just one, two, or three keys on the keyboard.

For details on chords, see "Chord Types for Style Playback" (page 26).

Setting the Fingering Type

The initial setting is "SmartChd." Select your desired fingering type.

1 Hold down [SHIFT] 19 and press [INTRO/ENDING/rit.] 12 to call up "FingType" (page 32, Function number 009).

"FingType" will be displayed for a few seconds, and then the current fingering type will be displayed.

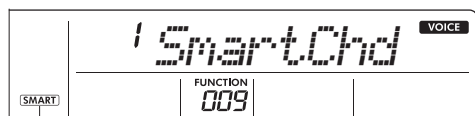
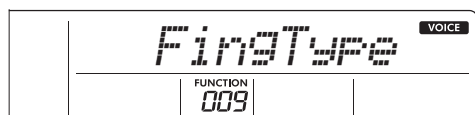

SMART Displayed when the fingering type is Smart Chord.

2 Press the Number buttons 14 or [+] 15 or [-] 16 to select "SmartChd" or "Multi."

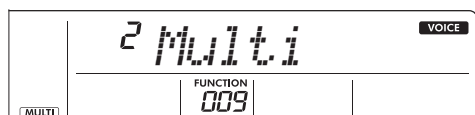

MULTI Displayed when the fingering type is Multi-Finger.

3 Press [STYLE] 18 to finish setting the fingering type.

Setting the Smart Chord Key

If you select Smart Chord as the fingering type, you can set the appropriate key of the Song to be played before playing, based on the number of sharps (#) and flats (b) written in the music score, and is called the Smart Chord Key. To set the Smart Chord Key, follow the steps below.

1 Hold down [SHIFT] 19 and press [MAIN/AUTO FILL] 12 to call up "S.ChdKey" (page 32, Function number 010).

The current Smart Chord Key will be displayed.

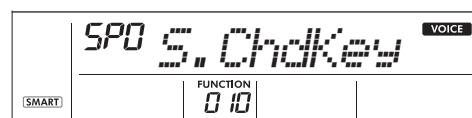

2 Press [+] or [-] 15 to set the Smart Chord Key that matches the music score.

For example, if you want to play the score below, set the smart chord key to "FL2 (2 flats)."



For details on the chords that are played depending on the Smart Chord Key settings, see page 27.

3 Press [STYLE] 18 to finish setting the Smart Chord Key.

Chord Types for Style Playback

When the fingering type (page 25) is set to “Multi-Finger (Multi),” play the keys that make up the chord in the Auto Accompaniment range. When the fingering type is set to “Smart Chord (SmartChd),” play the root note of “★” in the Auto Accompaniment range.

Major	Minor	Seventh	Minor Seventh	Major Seventh
C 	Cm 	C7 	Cm7 	CM7
D 	Dm 	D7 	Dm7 	DM7
E 	Em 	E7 	Em7 	EM7
F 	Fm 	F7 	Fm7 	FM7
G 	Gm 	G7 	Gm7 	GM7
A 	Am 	A7 	Am7 	AM7
B 	Bm 	B7 	Bm7 	BM7

- Inversions can be used as well as in “root” position—with the following exceptions:
m7, m7^b5, m7(11), 6, m6, sus4, aug, dim7, 7^b5, 6(9), sus2
- Inversions of the 7sus4 chords are not recognized if the notes are omitted.
- Sus2 chords are indicated by the root name only.
- When a chord that cannot be recognized by this instrument is played, no chord indication is shown on the display. In such a case, the Style playback will only be the rhythm and bass sound.

Easy Chords

This method lets you easily play chords in the accompaniment range of the keyboard using only one, two, or three fingers.

For root “C”



To play a major chord
Press the root note of the chord.



To play a minor chord
Press the root note together with the nearest black key to the left of it.



To play a seventh chord (7)
Press the root note together with the nearest white key to the left of it.



To play a minor seventh chord (m7)
Press the root note together with the nearest white and black keys to the left of it (three keys altogether).

Chords Played in Smart Chord Function

When the fingering type (page 25) is "SmartChd," set the Smart Chord Key (page 25) based on the key signature of the music score. When you turn on Style (**ACMP**) and play the root note in the Auto Accompaniment range, chords that match many melodies are selected according to the table below.

Key Signature	Smart Chord Key (display items)	Root Note											
		D \flat		E \flat		F \sharp		G \sharp		B \flat			
		C	D	E	F	G	A	B					
	FL7	C dim	D \flat m	D dim7	E \flat 1+5	E	F dim	F \sharp 7	G	G \sharp m	A	B \flat m7 \flat 5	B
	FL6	C dim	D \flat 7	D	E \flat m	E	F m7 \flat 5	F \sharp	G dim	G \sharp m	A dim7	B \flat 1+5	B
	FL5	C m7 \flat 5	D \flat	D dim	E \flat m	E dim7	F 1+5	F \sharp	G dim	G \sharp 7	A	B \flat m	B
	FL4	C 1+5	D \flat	D dim	E \flat 7	E	F m	F \sharp	G m7 \flat 5	G \sharp	A dim	B \flat m	B dim7
	FL3	C m	D \flat	D m7 \flat 5	E \flat	E dim	F m	F \sharp dim7	G 1+5	G \sharp	A dim	B \flat 7	B
	FL2	C m	D \flat dim 7	D 1+5	E \flat	E dim	F 7	F \sharp	G m	G \sharp	A m7 \flat 5	B \flat	B dim
	FL1	C 7	D \flat	D m	E \flat	E m7 \flat 5	F	F \sharp dim	G m	G \sharp dim7	A 1+5	B \flat	B dim
No key signature	SP0 (default)	C	D \flat dim	D m	E \flat dim7	E 1+5	F	F \sharp dim	G 7	G \sharp	A m	B \flat	B m7 \flat 5
	SP1	C	D \flat dim	D 7	E \flat	E m	F	F \sharp m7 \flat 5	G	G \sharp dim	A m	B \flat dim 7	B 1+5
	SP2	C	D \flat m7 \flat 5	D	E \flat dim	E m	F dim7	F \sharp 1+5	G	G \sharp dim	A 7	B \flat	B m
	SP3	C dim 7	D \flat 1+5	D	E \flat dim	E 7	F	F \sharp m	G	G \sharp m7 \flat 5	A	B \flat dim	B m
	SP4	C	D \flat m	D	E \flat m7 \flat 5	E	F dim	F \sharp m	G dim7	G \sharp 1+5	A	B \flat dim	B 7
	SP5	C dim	D \flat m	D dim7	E \flat 1+5	E	F dim	F \sharp 7	G	G \sharp m	A	B \flat m7 \flat 5	B
	SP6	C dim	D \flat 7	D	E \flat m	E	F m7 \flat 5	F \sharp	G dim	G \sharp m	A dim7	B \flat 1+5	B
	SP7	C m7 \flat 5	D \flat	D dim	E \flat m	E dim7	F 1+5	F \sharp	G dim	G \sharp 7	A	B \flat m	B

NOTE 1

- The "1+5" chord indication on the instrument's display is the same as that of a major chord.
- The chord names are shown on the instrument's display. Some notation may differ from that of commercially available music scores.

Have Fun with Sound Quizzes and Rhythms!

Try Guessing the Sound! (Sound Quiz)

This Quiz lets you guess the pitch of the sound or particular sound effect that is played.

1 Select the Voice you want to use for the Quiz (page 14).

Press [SFX KIT] ⑦ to take the Sound Effects Quiz.

2 When you press [SOUND QUIZ] ⑨, fanfare music sounds, and the Quiz will start.

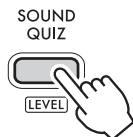

3 Find and play the same sound you hear from the instrument.

If you get it right, move on to the next question. You have 3 chances to answer. Do your best to guess the sound.

After answering, the correct answer will be shown on the display.

After answering all 10 questions, the Quiz ends, and your score is shown.

If you want to exit the Quiz in the middle, press [SOUND QUIZ] ⑨ again.

Selecting the Sound Quiz Level

You can select the difficulty of the Sound Quiz from auto or three levels of difficulty: 1–3 (Sound Quiz Level).

Hold down [SHIFT] ⑰ and press [SOUND QUIZ] ⑨ to call up “QuizLvl.” Then, press [+] or [-] ⑮ repeatedly to select the level.

Try the Memory Quiz!

This Quiz has you listen to a sample Song and lets you try playing it from memory.

1 When you press [MEMORY QUIZ] ⑩, fanfare music sounds, and the Quiz will start.

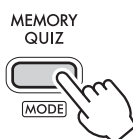

2 After the example finishes playing, play the notes.

The number of notes played for the question increases with each correct answer.

When you finish the Quiz to the end, the melody will be completed.

When you finish playing the melody to the end, or when you make a mistake three times on one question, the Quiz ends and your score is shown.

If you want to exit the Quiz in the middle, press [MEMORY QUIZ] ⑩ again.

Selecting the Memory Quiz Mode

The memory Quiz consists of a Melody mode (1 Melody) and Random mode (2 Random) (Memory Quiz Mode).

Hold down [SHIFT] ⑰ and press [MEMORY QUIZ] ⑩ to call up “QuizMode.” Then, press [+] or [-] ⑮ repeatedly to select the mode.

Play with Rhythm! (Rhythm Tutor)

Practice playing at the right time according to the rhythm.

1 Press [SONG] ⑬, and then press [RHYTHM TUTOR] ⑭.

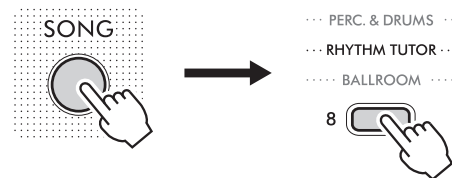

2 Press [START/STOP] ⑪ to start Rhythm Tutor.

3 A mark will move across the top of the display. Press the keyboard when it reaches the rightmost end.

When the mark reaches here, press the keyboard.

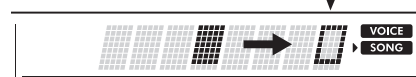

If you play at the correct timing, the letters “PAS” (Pass) will be shown.

As long as your timing is right, any key you play will be correct.

4 When the Song ends, the score will be shown.

Get into the rhythm and do your best to get a perfect score of 100!

If you want to exit the Rhythm Tutor in the middle, press [START/STOP] ⑪.

Recording Your Performance (Phrase Recording)

You can record your performance as User Song (Song number 123), which can then be played back on the instrument. The recorded User Song can be played back in the same way as the preset Songs.

NOTE

- A total of approximately 300 notes can be recorded to the User Song.

1 Select the desired Voice.

2 Press [PHRASE REC] **6** to enable the Record mode.

"UserSong" will be shown on the display.

PHRASE REC

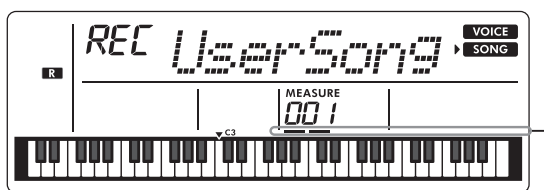

The bars will flash.

To exit the Record mode, press [PHRASE REC] **6** again. (The flashing bars will stop.)

NOTICE

- If a User Song has already been recorded, overwrite recording will be enabled (erasing the already recorded user song data and recording a new one).

3 Play the keyboard to start recording.

NOTICE

- Never attempt to turn the power off or to connect or disconnect the AC adaptor during recording. Doing so can result in a loss of data.

NOTE

- If the recording capacity becomes full during recording, "Mem Full" will appear on the display, recording will end, and the Song select display will appear.
- Recording will also start if you press [START/STOP] **1** without playing the keyboard.

Limitations while recording:

- The following settings/operations cannot be recorded: Reverb Level, Style, metronome click, Transpose, Tuning.
- The following settings and buttons are not available, or if operated, new settings cannot be recorded:
Split Point, Reverb Type, Chorus Type, [FUNCTION] **16**, [PORTABLE GRAND] **18**.

4 Press [START/STOP] **1** to stop recording.

5 Press [START/STOP] **1** to start playing the recorded song.

You can also play by selecting [USER] from the Category buttons **14** in Song selection (page 18).

NOTE

- User Song data can be erased by overwriting empty data. To do this, enable the Record mode in step 2, and then press [START/STOP] **1** twice in succession.

Selecting an EQ Setting for the Best Sound

Master equalizer (EQ) settings ensure the best sound when listening to a variety of playback systems, including your instrument's speakers, headphones, or an external speaker system.

- 1 Press [FUNCTION]  repeatedly until "MasterEQ (017)" appears.

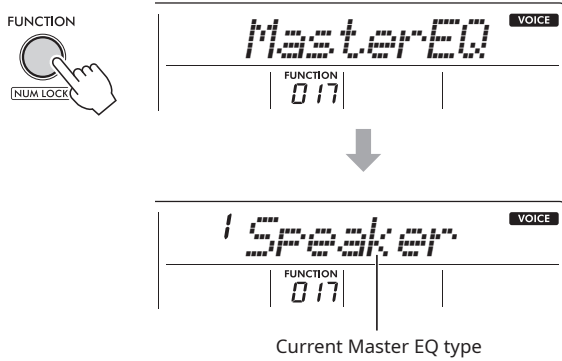

- 2 Press [+] or [-]  repeatedly to select the desired Master EQ type.

Master EQ types

1	Speaker	Optimum for listening via the instrument's built-in speakers.
2	Headphone	Optimum for headphones, or for listening via external speakers.
3	Boost	Features more powerful sound. However, depending on the type of Voice and Style you select, the sound may become more distorted than other EQ types.
4	Piano	Optimum for piano solo performances.
5	Bright	Lowers the mid range for a brighter sound.
6	Mild	Lowers the high range for a softer sound.

Playing an External Audio Device with the Built-in Speakers

You can output the sound of an external audio device, such as a smartphone, with the built-in speakers of this instrument by connecting it via a cable. This lets you play the keyboard along with playback from your audio player.

⚠ CAUTION

- When connecting this instrument to external devices, turn off all devices before making the connections. If you connect the device while it is turned on, there is a risk of electric shock or damage to the device. Also, to prevent damage to the instrument's speakers, etc., turn down the volume of devices to the minimum before connecting them.

NOTICE

- After connecting, first turn on the power to the external audio device and then to this instrument. Reverse this order when you turn the power off.

1 Connect the audio device to the instrument's [AUX IN] jack.

Use a conventional audio cable (having zero resistance) that has a stereo-mini plug on one side for connecting to the instrument and a proper plug to match the output jack of the external audio device on the other side.

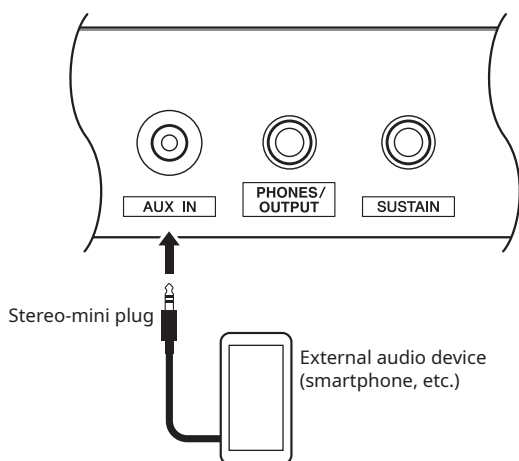

2 Turn on the audio device, and then turn on the instrument.

3 Start playback on the connected external audio device.

The sound of the audio device will be output through the speakers of the instrument.

4 Adjust the volume balance between the audio device and the instrument.

Adjust the playback volume of your audio device on the audio device.

5 Play the keyboard along with the playback sound from the audio device.

6 When you finish playing, stop playback on your audio device.

Function Settings

The Function settings provide access to various detailed instrument parameters including Tuning, Split Point, Voices, Effects, and battery type.

1 Press [FUNCTION] **16** repeatedly until the desired item appears.

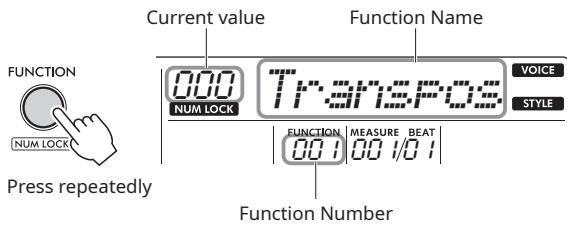

To decrease the Function Number by one, simultaneously hold down [FUNCTION] **16** and press [-] **15** briefly. Simply pressing only [+] or [-] **15** does not change the Function Number. The selected Function Name is displayed for a few seconds, and then the current setting value is displayed.

2 Set the value by using the Number buttons **14**, [+] or [-] **15** buttons.

Press [+] and [-] **15** simultaneously to restore the default setting.

NOTE

- When setting one of the Functions, the **NUM LOCK** icon automatically lights up, and you can use the VOICE/SONG/STYLE Category buttons **14** as Number buttons **14** to change the setting value.

3 To exit the Function settings, press one of these buttons: [VOICE], [SONG] or [STYLE] **13**.

Function List

Function Number	Function Name	Display	Range/Settings	Default Value	Description
Overall					
001	Transpose	<i>Transpos</i>	-12-12	0	Sets the pitch of the instrument in semitone increments.
002	Tuning	<i>Tuning</i>	427.0 Hz-453.0 Hz	440.0 Hz	Sets the fine tuning of the pitch of the entire instrument in approx. 0.2 Hz increments.
003	Split Point	<i>SplitPnt</i>	036-096 (C1-C6)	054 (F#2)	Sets the highest note (split point) of the Auto Accompaniment range (page 23).
Voice (page 14)					
004	Volume	<i>M. Volume</i>	000-127	*	Adjusts the volume of keyboard performances when performing along with a Song or a Style.
005	Octave	<i>M. Octave</i>	-2-2	*	Sets the pitch of keyboard performances in octaves.
006	Reverb Level	<i>M. Reverb</i>	000-127	*	Sets the amount of reverb applied to the Voice (see "Reverb Type" on page 33).
007	Chorus Depth	<i>M. Chorus</i>	000-127	*	Sets the amount of chorus applied to the Voice (see "Chorus Type" on page 33).
Style (page 23)					
008	Style Volume	<i>StyleVol</i>	000-127	100	Sets the Style playback volume when selecting a Style (page 24).
009	Fingering Type	<i>FingType</i>	1 (SmartChd) 2 (Multi)	1 (SmartChd)	Sets how to play the chord in the Auto Accompaniment range when playing with a Style.
010	Smart Chord Key	<i>S. ChdKey</i>	FL7 (7 Flats ♭) – SP0 (No Key Signature) – SP7 (7 Sharps #)	SP0 (No Key Signature)	Sets the Key Signature for Style playback when the Fingering Type is set to "Smart Chord." For example, if there are 2 sharps (#) on your music score, press [+] or [-] 15 until "SP2" appears on the display.

Function Number	Function Name	Display	Range/Settings	Default Value	Description
Song (page 18)					
011	Song Volume	<i>SongVol</i>	000-127	100	Sets the Song playback volume when selecting a Song (page 18).
012	Song Melody Voice (page 19)	<i>MelodyVc</i>	001-410	**	Allows you to change the melody Voice of the preset Song to a different desired Voice.
Effect					
013	Reverb Type (page 16)	<i>Reverb</i>	01-03 (Hall 1-3) 04-05 (Room 1-2) 06-07 (Stage 1-2) 08-09 (Plate 1-2) 10 (Off)	**	Selects the Reverb type. For reverb types, see "Effect Type List" (page 47).
014	Reverb Total Level	<i>RevLevel</i>	000-127	64	Sets the amount of reverb.
015	Chorus Type (page 16)	<i>Chorus</i>	1 (Chorus1) 2 (Chorus2) 3 (Chorus3) 4 (Flanger1) 5 (Flanger2) 6 (Off)	**	Selects the Chorus type. For chorus types, see "Effect Type List" (page 47).
016	Panel Sustain (page 16)	<i>Sustain</i>	on/off (off)	oFF (off)	Sets whether to turn the Panel Sustain function of this instrument on or off.
017	Master EQ Type (page 30)	<i>MasterEQ</i>	1 (Speaker) 2 (Headphone) 3 (Boost) 4 (Piano) 5 (Bright) 6 (Mild)	1 (Speaker)	Sets the sound output from the speakers to your preference depending on the environment in which the instrument is played.
018	Wide Type (page 15)	<i>Wide</i>	1 (Wide1) 2 (Wide2) 3 (Wide3) 4 (Wide Off)	4 (Wide Off)	Sets the Ultra-Wide Stereo type. Higher values produce a greater Wide effect (except for 4).
Quiz (page 28)					
019	Sound Quiz Level	<i>QuizLvl</i>	AUt (Auto), 001, 002, 003	AUt (Auto)	Allows you to select the Sound Quiz Level. AUt: Auto 001 to 003: The higher the number, the higher the difficulty level.
020	Memory Quiz Mode	<i>QuizMode</i>	1 (Melody) 2 (Random)	1 (Melody)	You can select the Memory Quiz Mode. Melody: A song is heard. Random: Randomly generated sounds are presented in sequence (up to 30 sounds).
Metronome (page 15)					
021	Time Signature Numerator	<i>TimeSig</i>	00-15	**	Sets the time signature of the Metronome (with "4" as the fixed denominator).
022	Metronome Volume	<i>MetroVol</i>	000-127	100	Sets the volume of the Metronome.
Lesson (page 21)					
023	Your Tempo	<i>YourTemp</i>	on/off (off)	on	Sets whether the tempo of the Song changes (on) or does not change (off) according to the playing pace in "Lesson 3—Your own pace (WAITING)."
Duo (page 17)					
024	Duo Mode	<i>DuoMode</i>	on/off (off)	oFF (off)	Turns Duo Mode (page 17) on or off.
025	Duo Type	<i>DuoType</i>	1 (Balance) 2 (Separate)	2 (Separate)	Sets how sounds are output from the speakers in the Duo Mode.

Function Settings

Function Number	Function Name	Display	Range/Settings	Default Value	Description						
Demo (page 18)											
026	Demo Group	<i>Demogrpf</i>	1 (Demo) 2 (Preset) 3 (User)	1 (Demo)	<p>Selects the playback group to repeat. After holding down [DEMO] 3 for longer than a second to select a playback Demo Group, press [DEMO] 3 again to start playback of all preset Songs in each Demo Group.</p> <table border="1"> <tr> <td>Demo</td> <td>Preset Songs (Song Number: 001-003)</td> </tr> <tr> <td>Preset</td> <td>All preset Songs (Song Number: 001-100)</td> </tr> <tr> <td>User</td> <td>User Song (Song Number: 123)</td> </tr> </table>	Demo	Preset Songs (Song Number: 001-003)	Preset	All preset Songs (Song Number: 001-100)	User	User Song (Song Number: 123)
Demo	Preset Songs (Song Number: 001-003)										
Preset	All preset Songs (Song Number: 001-100)										
User	User Song (Song Number: 123)										
027	Demo Play Mode	<i>PlayMode</i>	1 (Normal) 2 (Random)	1 (Normal)	Selects the repeat playback mode.						
Auto Power Off (page 6)											
028	Auto Power Off Time	<i>AutoOfff</i>	oFF (off), 5/10/15/30/60/ 120 (minutes)	30 (minutes)	Sets the time that will elapse before the instrument's power is automatically turned off.						
Battery (page 5)											
029	Battery Type	<i>Battery</i>	1 (Alkaline) 2 (Ni-MH)	1 (Alkaline)	<p>Selects the type of batteries you have inserted into the instrument.</p> <table border="1"> <tr> <td>Alkaline</td> <td>Alkaline batteries or manganese batteries</td> </tr> <tr> <td>Ni-MH</td> <td>Rechargeable nickel metal hydride batteries</td> </tr> </table>	Alkaline	Alkaline batteries or manganese batteries	Ni-MH	Rechargeable nickel metal hydride batteries		
Alkaline	Alkaline batteries or manganese batteries										
Ni-MH	Rechargeable nickel metal hydride batteries										

* The appropriate value is automatically set for each Voice combination.

** The appropriate value is automatically set for the currently selected Song or Style.

NOTE

- For details on settings that are retained even when the power is turned off, backup, and initialization, see page 35.

Backup and Initialization

Backup Parameters

The following settings are automatically backed up on the instrument, so they are not erased even when the power is turned off.

Backup parameters

- **User Song (page 29)**
- **Function Settings (page 32):**
 - Tuning, Fingering Type, Master EQ Type, Your Tempo, Auto Power Off Time, Battery Type

To initialize backup data (which erases your custom settings), execute "Backup Clear" described at right.

NOTICE

- Backup is performed automatically when you turn off the power. However, note that the settings of the backup parameters cannot be backed up or maintained in the following situations.
 - When the AC adaptor is unplugged with the power turned on (even if batteries are installed)
 - When the power is turned off due to an accident such as electric power failure
 - When the batteries run down
 - When the AC adaptor is plugged while using batteries

Initialization (Backup Clear)

This function erases any custom backup data and restores the settings to the factory defaults. To perform initialization, follow the instructions below.

Backup Clear

This operation initializes the backup parameters.

While holding down the highest white key, press the [⏻] (Standby/On) switch to turn the power on.

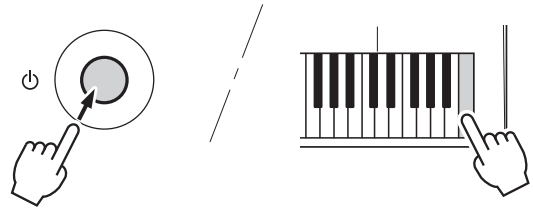

Troubleshooting

Problem	Possible Cause and Solution
When you press the [⏻] (Standby/On) switch to turn on or turn off the power, a popping sound is temporarily produced.	This is normal and indicates that the instrument is receiving electrical power.
Noise is heard from the instrument's speakers or headphones when using a mobile phone (or the mobile phone is ringing) near this instrument.	Turn off your mobile phone. If you use a mobile phone near this instrument, noise may be heard.
Noise is heard from the instrument's speakers or headphones when using the instrument with an application on a smart device.	When you use the instrument along with an application on your smart device, we recommend that you set "Airplane Mode" to "ON" on your smart device in order to avoid noise caused by communication.
No sound is heard from the instrument's speakers even when the keyboard is played or when a Song or Style is being played back.	Check that nothing is connected to the [PHONES/OUTPUT] jack on the rear panel. When a set of headphones is plugged into this jack, no sound is output.
Some keys played at the same time do not sound. When you play the keyboard, the Song or Style performance sound or metronome sound is interrupted.	The maximum number of simultaneous polyphony (32 notes) for this instrument has been exceeded. You can play up to 32 notes, including Song, Style, metronome, etc. If this amount is exceeded to 33 or more notes, some of the sounds being produced will be cancelled.
The sound volume does not change, regardless of how strongly or softly you play the keyboard.	Since this keyboard does not have touch response, the level of the sound does not change in response to your playing strength.
The ACMP icon does not appear when [ACMP ON/OFF] 12 is pressed.	<ul style="list-style-type: none"> • Always press [STYLE] 13 first when you are going to use any Style-related function. • The icon does not appear when the Duo mode is turned on.
Styles are not playing correctly.	<p>Make sure that the Style Volume is set to an appropriate level (page 32, Function number 008).</p> <p>Make sure that the split point is set to an appropriate position for the chords you are playing in "Function Settings" (page 32, Function number 003). If the ACMP icon is not shown on the display, press [ACMP ON/OFF] 12 again so that it does appear.</p>
The Style is not playing as you play a chord.	<ul style="list-style-type: none"> • The Auto Accompaniment will sometimes not change when related chords are played in sequence (e.g., some minor chords followed by the minor seventh with the same root note). • Two-note fingerings will produce a chord based on the previously played chord. • Playing two same-root keys in the adjacent octaves produces accompaniment based only on the root.
The foot switch (for sustain) seems to produce the opposite effect. For example, pressing the foot switch cuts off the sound, and releasing it sustains the sound.	This is because you connected the foot switch after turning on the power or turned on the power while stepping on the foot switch. Connect the foot switch with the power turned off, and then turn on the power without stepping on the foot switch.
The sound quality and volume change depending on the key you play.	This is normal. The AWM sound source system adopted in this instrument uses a method called "multi-sampling," which divides the keyboard into several sections and samples the instrument's sound, in order to enable realistic instrument expression. Thus, the quality and volume of these Voices may vary slightly depending on the range.
<ul style="list-style-type: none"> • The volume is too soft. • The sound quality is poor. • The rhythm stops unexpectedly or will not play. • Songs, etc. are not played correctly. • The LCD display suddenly goes dark, and all panel settings are reset. 	The batteries are low or depleted. Replace all six batteries with completely new ones, or use the included AC adaptor.

Problem	Possible Cause and Solution
The power suddenly and unexpectedly turns off.	This is normal, and the Auto Power Off function may have been activated (page 6). If you need to disable the Auto Power Off function, set the function to off in "Function Settings" (page 34, Function number 028).
When you press the [⏻] (Standby/On) switch and turn on the power, the power turns off immediately.	Make sure to use the included or specified AC adaptor (page 48).

Voice List

Maximum Polyphony

The instrument has 32-note maximum polyphony. This means that it can play a maximum of up to 32 notes at once, regardless of what functions are used. Auto Accompaniment uses a number of the available notes, so when Auto Accompaniment is used the total number of available notes for playing on the keyboard is correspondingly reduced. The same applies to the Song functions. If the maximum polyphony is exceeded, earlier played notes will be cut off and the most recent notes have priority (last note priority).

NOTE

- Some voices may sound continuously or have a long decay after the notes have been released while the sustain pedal (foot switch) is held.

Voice No.	Voice Name
PIANO	
001	Grand Piano
002	Electric Piano 1
003	Harpsichord 1
004	Clavi
005	Bright Piano
006	Mellow Piano
007	Honky Tonk Piano
008	Electric Piano 2
009	Electric Grand Piano
010	Chorus Electric Piano 1
011	Piano Strings
012	Dream
ORGAN	
013	Drawbar Organ 1
014	Percussive Organ 1
015	16+2'2/3 Organ
016	Rock Organ
017	Rotary Organ
018	Pipe Organ 1
019	Accordion
020	Tango Accordion 1
021	Harmonica 1
022	Drawbar Organ 2
023	60s Drawbar Organ 1
024	70s Drawbar Organ 1
025	Percussive Organ 2
026	Detuned Percussive Organ
027	Notre Dame
028	Reed Organ
GUITAR&BASS	
029	Nylon Guitar
030	Steel Guitar
031	Clean Guitar
032	Overdriven Guitar
033	Distortion Guitar
034	Muted Guitar
035	Finger Bass 1
036	Acoustic Bass 1
037	Pick Bass
038	Fretless Bass 1
039	Slap Bass 1
040	Slap Bass 2
041	Synth Bass 1
042	Techno Synth Bass
043	DX Bass

Voice No.	Voice Name
STRINGS	
044	Strings 1
045	Strings 2
046	Tremolo Strings
047	Orchestra 1
048	Pizzicato Strings
049	Violin
050	Cello
051	Contrabass
052	Orchestral Harp
053	Synth Strings 1
054	Synth Strings 2
055	Orchestra Hit 1
056	Choir Aahs
057	Voice Oohs
058	Synth Voice 1
WIND	
059	Brass Section
060	Trumpet
061	Trombone 1
062	French Horn 1
063	Tuba
064	Muted Trumpet
065	Sax Section
066	Tenor Sax
067	Alto Sax
068	Soprano Sax
069	Flute
070	Piccolo
071	Clarinet
072	Oboe
073	Recorder
074	Ocarina
075	Synth Brass 1
076	Resonant Synth Brass
SYNTH	
077	Square Lead 1
078	Sawtooth Lead 1
079	Portatone
080	Under Heim
081	Sine Lead
082	Voice Lead
083	Fifths Lead
084	Funky Lead
085	Fargo
086	Analogon

Voice No.	Voice Name
087	Bell Pad
088	New Age Pad
089	Fantasia
090	Dream Heaven
091	Symbiont
092	Fantasy
093	Bowed Pad
094	Metallic Pad
095	Xenon Pad
096	Halo Pad
097	Crystal
098	Atmosphere
099	Brightness
100	Sweep Pad
101	Rain
102	Sound Track
WORLD	
103	Er Hu
104	Di Zi
105	Pi Pa
106	Sitar 1
107	Pungi
108	Harmonium 1 (Single Reed)
109	Shakuhachi
110	Koto
111	Pan Flute
112	Kanoon
113	Oud
114	Fiddle
115	Bagpipe
116	Dulcimer 1
117	Kalimba
PERC.&DRUMS	
118	Vibraphone
119	Marimba
120	Xylophone
121	Glockenspiel
122	Steel Drums
123	Tubular Bells
124	Timpani
125	Standard Kit 1
126	Chinese Kit
127	Indian Kit 1
128	Indian Kit 2
129	Arabic Kit
130	SE Kit 1

Voice No.	Voice Name
131	SE Kit 2
132	SE Kit 3
133	SFX Kit
OTHERS	
134	Mono Grand Piano
135	Harpsichord 2
136	Electric Piano 3
137	Chorus Electric Piano 2
138	Detuned Electric Piano
139	DX + Analog Electric Piano
140	Wah Clavi
141	60s Drawbar Organ 2
142	60s Drawbar Organ 3
143	70s Drawbar Organ 2
144	Detuned Drawbar Organ
145	70s Percussive Organ
146	Organ Bass
147	Slow Rotary Organ
148	Fast Rotary Organ
149	Pipe Organ 2
150	Pipe Organ 3
151	Organ Flute
152	Tremolo Organ Flute
153	Cheezy Organ
154	Light Organ
155	Puff Organ
156	Tango Accordion 2
157	Harmonica 2
158	Nylon & Steel Guitar
159	Steel Guitar with Body Sound
160	Muted Steel Guitar
161	12-string Guitar
162	Jazz Guitar
163	Jazz Amp
164	Jazz Man
165	Chorus Guitar
166	Funk Guitar
167	Guitar Pinch
168	Feedback Guitar 1
169	Feedback Guitar 2
170	Guitar Feedback
171	Guitar Harmonics 1
172	Guitar Harmonics 2
173	Guitar Harmonics 3
174	Acoustic Bass 2
175	Finger Bass 2
176	Finger Dark
177	Finger Slap Bass
178	Fretless Bass 2
179	Fretless Bass 3
180	Fretless Bass 4
181	Slap Bass 3
182	Jazz Rhythm
183	Bass & Distorted Electric Guitar

Voice No.	Voice Name
184	Muted Pick Bass
185	Modulated Bass
186	Punch Thumb Bass
187	Synth Bass 2
188	Synth Bass 2 Dark
189	Mellow Synth Bass
190	Sequenced Bass
191	Click Synth Bass
192	Modular Synth Bass
193	Strings 3
194	Slow Strings
195	Stereo Strings
196	Stereo Slow Strings
197	Orchestra 2
198	60s Strings
199	Suspense Strings
200	Legato Strings
201	Warm Strings
202	Kingdom
203	Slow Tremolo Strings
204	Tremolo Orchestra
205	Slow Violin
206	Viola
207	Orchestra Hit 2
208	Impact
209	Stereo Choir
210	Mellow Choir
211	Choir Strings
212	Synth Voice 2
213	Choral
214	Analog Voice
215	Breathy Tenor Sax
216	Baritone Sax
217	English Horn
218	Bassoon
219	Warm Trumpet
220	Trombone 2
221	Trumpet & Trombone Section
222	French Horn 2
223	French Horn Solo
224	Horn Orchestra
225	Synth Brass 2
226	Soft Brass
227	Choir Brass
228	Blown Bottle
229	Whistle
230	Square Lead 2
231	LM Square
232	Sawtooth Lead 2
233	Thick Sawtooth
234	Dynamic Sawtooth
235	Digital Sawtooth
236	Solo Sine
237	Calliope Lead

Voice No.	Voice Name
238	Chiff Lead
239	Charang Lead
240	Bass & Lead
241	Hollow
242	Shroud
243	Mellow
244	Big Lead
245	Sequenced Analog
246	Pure Lead
247	Distorted Lead
248	Big Five
249	Big & Low
250	Fat & Perky
251	Warm Pad
252	Poly Synth Pad
253	Equinox
254	Choir Pad
255	Soft Whirl
256	Itopia
257	Goblins
258	Echoes
259	Sci-Fi
260	African Wind
261	Carib
262	Prologue
263	Synth Drum Comp
264	Popcorn
265	Tiny Bells
266	Round Glockenspiel
267	Glockenspiel Chimes
268	Clear Bells
269	Chorus Bells
270	Soft Crystal
271	Air Bells
272	Warm Atmosphere
273	Hollow Release
274	Nylon Electric Piano
275	Nylon Harp
276	Harp Vox
277	Atmosphere Pad
278	Goblins Synth
279	Creeper
280	Ritual
281	To Heaven
282	Night
283	Glisten
284	Bell Choir
285	Bell Harp
286	Soft Vibraphone
287	Soft Marimba
288	Sine Marimba
289	Balimba
290	Log Drums
291	Celesta

Voice List

















Voice No.	Voice Name
292	MusicBox 1
293	MusicBox 2
294	Church Bells
295	Carillon
296	Tinkle Bell
297	Agogo
298	Woodblock
299	Castanets
300	Melodic Tom 1
301	Melodic Tom 2
302	Real Tom
303	Rock Tom
304	Electronic Percussion
305	Analog Tom
306	Synth Drum
307	Taiko Drum
308	Gran Cassa
309	Gamelimba
310	Glass Percussion
311	Reverse Cymbal
312	Banjo
313	Muted Banjo
314	Dulcimer 2
315	Cimbalom
316	Santur
317	Rabab
318	Harmonium 2 (Double Reed)
319	Harmonium 3 (Triple Reed)
320	Tanpura
321	Sitar 2
322	Detuned Sitar
323	Shehnai
324	Gopichant
325	Tabla
326	Gu Zheng
327	Yang Qin
328	Shamisen
329	Taisho-kin
330	Mandolin
331	Ukulele
332	Bonang
333	Altair
334	Gamelan Gongs
335	Stereo Gamelan Gongs
336	Rama Cymbal
337	Thai Bells
338	Fret Noise
339	Breath Noise
340	Cutting Noise 1
341	Cutting Noise 2
342	String Slap
343	Flute Key Click
344	Bird Tweet 1
345	Bird Tweet 2





















Voice No.	Voice Name
346	Telephone Ring 1
347	Telephone Ring 2
348	Phone Call
349	Shower
350	Thunder
351	Wind
352	Stream
353	Seashore
354	Bubble
355	Feed
356	Dog
357	Horse
358	Maou
359	Door Squeak
360	Door Slam
361	Scratch Cut
362	Scratch Split
363	Wind Chime
364	Car Engine Ignition
365	Car Tires Squeal
366	Car Passing
367	Car Crash
368	Siren
369	Train
370	Helicopter
371	Jet Plane
372	Starship
373	Burst
374	Roller Coaster
375	Submarine
376	Laugh
377	Scream
378	Punch
379	Heartbeat
380	Footsteps
381	Applause
382	Gunshot
383	Machine Gun
384	Laser Gun
385	Explosion
386	Firework
387	Standard Kit 2
388	Room Kit
389	Rock Kit
390	Electronic Kit
391	Analog Kit
392	Dance Kit
393	Jazz Kit
394	Brush Kit
395	Symphony Kit
DUAL	
396	Octave Piano
397	Piano & Pizzicato Strings
398	Piano & Flute

Voice No.	Voice Name
399	Piano Pad
400	Octave Honky Tonk Piano
401	Harpsichord & Strings
402	Electric Piano Pad 1
403	Electric Piano Pad 2
404	Electric Piano Pad 3
405	Octave Strings
406	Octave Brass
407	Orchestra Tutti
408	Octave Choir
409	Jazz Section
410	Flute & Clarinet

* When you select a Voice of the "DUAL" category, two voices sound at the same time.

SFX Kit List

		Voice No. 133	
		SFX Kit	
C1	C 1		Punch
C#1	C# 1		Laugh
D1	D 1		Footsteps
D#1	D# 1		Scream
E1	E 1		Handclap
F1	F 1		Applause
F#1	F# 1		Question Setting
G1	G 1		Announcement Start
G#1	G# 1		Correct
A1	A 1		Announcement End
A#1	A# 1		Wrong
B1	B 1		Gong 1
C2	C 2		Gong 2
C#2	C# 2		Camera
D2	D 2		Spray
D#2	D# 2		Short Circuit
E2	E 2		Cut
F2	F 2		Whisk in a Bowl
F#2	F# 2		Boil in a Saucepan
G2	G 2		Put Ice in a Glass
G#2	G# 2		Pull out a Cork
A2	A 2		Pour into a Glass
A#2	A# 2		Water
B2	B 2		Water Drop
C3	C 3		Cat
C#3	C# 3		Dog
D3	D 3		Cow
D#3	D# 3		Horse
E3	E 3		Goat

		Voice No. 133	
		SFX Kit	
F3	F 3		Sheep
F#3	F# 3		Lion
G3	G 3		Owl
G#3	G# 3		Rooster
A3	A 3		Bird
A#3	A# 3		Frog
B3	B 3		Insect
C4	C 4		Door Squeak
C#4	C# 4		Door Slam
D4	D 4		Dial Tone
D#4	D# 4		Alarm Bell
E4	E 4		Bicycle Horn
F4	F 4		Siren
F#4	F# 4		Car Passing
G4	G 4		Railroad Crossing
G#4	G# 4		Steam Engine Whistle
A4	A 4		Train
A#4	A# 4		Helicopter
B4	B 4		Jet Plane
C5	C 5		UFO
C#5	C# 5		Car Engine Ignition
D5	D 5		Car Horn
D#5	D# 5		Metallic Sound
E5	E 5		Laser
F5	F 5		Chime
F#5	F# 5		Cash register drawer
G5	G 5		Barcode Scanner
G#5	G# 5		Zipper
A5	A 5		Cuckoo Clock
A#5	A# 5		Clock Tick
B5	B 5		Big Clock
C6	C 6		Chau Gong

Drum Kit List

* : Same as Standard Kit 1
 * : No Sound
 * Each percussion voice uses one note.

	VoiceNo.		125	126	127	128	129	
	Keyboard		Standard Kit 1	Chinese Kit	Indian Kit 1	Indian Kit 2	Arabic Kit	
	Note No.	Note						
C1		36	C 1	Seq Click H		Baya ge	Baya ge	Khaligi Clap 1
	C#1	37	C# 1	Brush Tap		Baya ke	Baya ke	Arabic Zalgouta Open
D1		38	D 1	Brush Swirl		Baya ghe	Baya ghe	Khaligi Clap 2
	D#1	39	D# 1	Brush Slap		Baya ka	Baya ka	Arabic Zalgouta Close
E1		40	E 1	Brush Tap Swirl		Tabla na	Tabla na	Arabic Hand Clap
F1		41	F 1	Snare Roll		Tabla tin	Tabla tin	Tablet Tak 1
	F#1	42	F# 1	Castanet		Tablabaya dha	Tablabaya dha	Sagat 1
G1		43	G 1	Snare Soft		Dhol 1 Open	Tabla tun	Tablet Dom
	G#1	44	G# 1	Sticks		Dhol 1 Slap	Tablabaya dhin	Sagat 2
A1		45	A 1	Bass Drum Soft		Dhol 1 Mute	Tabla di	Tablet Tak 2
	A#1	46	A# 1	Open Rim Shot		Dhol 1 Open Slap	Tablabaya dhe	Sagat 3
B1		47	B 1	Bass Drum Hard		Dhol 1 Roll	Tabla ti	Riq Tik 3
C2		48	C 2	Bass Drum		Dandia Short	Tabla ne	Riq Tik 2
	C#2	49	C# 2	Side Stick		Dandia Long	Tabla taran	Riq Tik Hard 1
D2		50	D 2	Snare		Chutki	Tabla tak	Riq Tik 1
	D#2	51	D# 2	Hand Clap		Chipri	Chipri	Riq Tik Hard 2
E2		52	E 2	Snare Tight		Khanjira Open	Kanjira Open	Riq Tik Hard 3
F2		53	F 2	Floor Tom L		Khanjira Slap	Kanjira Slap	Riq Tish
	F#2	54	F# 2	Hi-Hat Closed		Khanjira Mute	Kanjira Mute	Riq Snouj 2
G2		55	G 2	Floor Tom H		Khanjira Bendup	Kanjira Bend up	Riq Roll
	G#2	56	G# 2	Hi-Hat Pedal		Khanjira Benddown	Kanjira Bend down	Riq Snouj 1
A2		57	A 2	Low Tom		Dholak 1 Open	Dholak Open	Riq Sak
	A#2	58	A# 2	Hi-Hat Open		Dholak 1 Mute	Dholak Mute	Riq Snouj 3
B2		59	B 2	Mid Tom L		Dholak 1 Slap	Dholak Slap	Riq Snouj 4
C3		60	C 3	Mid Tom H		Dhol 2 Open	Dhol Open	Riq Tak 1
	C#3	61	C# 3	Crash Cymbal 1		Dhol 2 Slap	Dhol Mute	Riq Brass 1
D3		62	D 3	High Tom		Dhol 2 Rim	Dhol Slap	Riq Tak 2
	D#3	63	D# 3	Ride Cymbal 1		Mridangam na	Dhol Slide	Riq Brass 2
E3		64	E 3	Chinese Cymbal		Mridangam din	Mridangam Normal	Riq Dom
F3		65	F 3	Ride Cymbal Cup		Mridangam ki	Mridangam Open	Katem Tak Doff
	F#3	66	F# 3	Tambourine		Mridangam ta	Mridangam Mute	Katem Dom
G3		67	G 3	Splash Cymbal		Mridangam Chapu	Mridangam Slap	Katem Sak 1
	G#3	68	G# 3	Cowbell		Mridangam Lo Closed	Mridangam Rim	Katem Tak 1
A3		69	A 3	Crash Cymbal 2		Mridangam Lo Open	Chimta Open	Katem Sak 2
	A#3	70	A# 3	Vibraslap		Chimta Normal	Chimta Normal	Katem Tak 2
B3		71	B 3	Ride Cymbal 2		Chimta Ring	Chimta Ring	Daholla Sak 2
C4		72	C 4	Bongo H		Dholki Hi Open	Dholki Open	Daholla Sak 1
	C#4	73	C# 4	Bongo L		Dholki Hi Mute	Dholki Mute	Daholla Tak 1
D4		74	D 4	Conga H Mute		Dholki Lo Open	Dholki Slap	Daholla Dom
	D#4	75	D# 4	Conga H Open		Dholki Hi Slap	Dholki Slide	Daholla Tak 2
E4		76	E 4	Conga L		Dholki Lo Slide	Dholki Rim	Tablah Prok
F4		77	F 4	Timbale H		Khol Open	Khol Open	Tablah Dom 2
	F#4	78	F# 4	Timbale L		Khol Slide	Khol Slide	Tablah Roll of Edge
G4		79	G 4	Agogo H	Dagu Mute	Khol Mute	Khol Mute	Tablah Tak Finger 4
	G#4	80	G# 4	Agogo L	Zhongcha Mute	Manjira Open	Manjira Open	Tablah Tak Trill 1
A4		81	A 4	Cabasa	Dagu Heavy	Manjira Close	Manjira Close	Tablah Tak Finger 3
	A#4	82	A# 4	Maracas	Zhongcha Open	Jhanji Open	Jhanji Open	Tablah Tak Trill 2
B4		83	B 4	Samba Whistle H	Paigu Middle	Jhanji Close	Jhanji Close	Tablah Tak Finger 2
C5		84	C 5	Samba Whistle L	Paigu Low	Mondira Open	Mondira Open	Tablah Tak Finger 1
	C#5	85	C# 5	Guiro Short	Xiaocha Mute	Mondira Close	Mondira Close	Tablah Tik 2
D5		86	D 5	Guiro Long	Bangu	Indian Bhangra Scat 1	Mridang Open	Tablah Tik 4
	D#5	87	D# 5	Claves	Xiaocha Open	Indian Bhangra Scat 2	Mridang Mute	Tablah Tik 3
E5		88	E 5	Wood Block H	Bangzi	Indian Bhangra Scat 3	Mridang Rim	Tablah Tik 1
F5		89	F 5	Wood Block L	Muyu Low	Indian Bhangra Scat 4	Mridang Slide	Tablah Tak 3
	F#5	90	F# 5	Cuica Mute	Zhongluo Mute	Khomokh Normal	Khomokh Normal	Tablah Tak 1
G5		91	G 5	Cuica Open	Muyu Mid-Low	Khomokh Mute	Khomokh Mute	Tablah Tak 4
	G#5	92	G# 5	Triangle Mute	Zhongluo Open	Khomokh Mltatk	Khomokh Mltatk	Tablah Tak 2
A5		93	A 5	Triangle Open	Muyu Middle	Thavil Open	Madal-A2	Tablah Sak 2
	A#5	94	A# 5	Shaker	Xiaoluo Open	Thavil Slap	Madal-A#2	Tablah Tremolo
B5		95	B 5	Jingle Bells	Triangle Mute	Thavil Mute	Madal-B2	Tablah Sak 1
C6		96	C 6	Bell Tree	Triangle Open	Khartaal	Madal-C3	Tablah Dom 1

	VoiceNo.	Keyboard		130	131	132	133	387	388	389	
		Note No.	Note	SE Kit 1	SE Kit 2	SE Kit 3	SFX Kit	Standard Kit 2	Room Kit	Rock Kit	
C1	C#1	36	C 1	Cutting Noise 1	Phone Call	Drum Loop	Punch				
D1	D#1	37	C# 1	Cutting Noise 2	Door Squeak		Laugh				
E1		38	D 1		Door Slam		Footsteps				
F1	F#1	39	D# 1	String Slap	Scratch Cut		Scream				
G1	G#1	40	E 1		Scratch		Handclap				
A1	A#1	41	F 1		Wind Chime		Applause				
B1		42	F# 1		Telephone Ring		Question Setting				
C2	C#2	43	G 1				Announcement Start	Snare Soft 2		Snare Noisy	
D2	D#2	44	G# 1				Correct				
E2		45	A 1				Announcement End				
F2	F#2	46	A# 1				Wrong	Open Rim Shot 2			
G2	G#2	47	B 1				Gong 1			Bass Drum H	
A2	A#2	48	C 2				Heartbeat	Gong 2	Bass Drum 2		Bass Drum Rock
B2		49	C# 2			Footsteps	Camera 2				
C3	C#3	50	D 2			Door Squeak	Spray	Snare 2	Snare Room L	Snare Rock	
D3	D#3	51	D# 2			Door Slam	Short Circuit				
E3		52	E 2	Flute Key Click	Car Engine Ignition	Applause	Cut	Snare Tight 2	Snare Room H	Snare Rock Rim	
F3	F#3	53	F 2		Car Tires Squeal	Camera 1	Whisk in a bowl		Tom Room 1	Tom Rock 1	
G3	G#3	54	F# 2		Car Passing	Car Horn	Simmer in a saucepan				
A3	A#3	55	G 2		Car Crash	Hiccup	Fill a glass with ice		Tom Room 2	Tom Rock 2	
B3		56	G# 2		Siren	Cuckoo Clock	Uncorked				
C4	C#4	57	A 2		Train	Stream	Pour into a cup		Tom Room 3	Tom Rock 3	
D4	D#4	58	A# 2		Jet Plane	Frog	Running Water				
E4		59	B 2		Starship	Rooster	Splash		Tom Room 4	Tom Rock 4	
F4	F#4	60	C 3		Burst	Dog	Cat		Tom Room 5	Tom Rock 5	
G4	G#4	61	C# 3		Roller Coaster	Cat	Dog				
A4	A#4	62	D 3		Submarine	Owl	Cow		Tom Room 6	Tom Rock 6	
B4		63	D# 3			Horse Gallop	Horse				
C5	C#5	64	E 3			Horse	Goat				
D5	D#5	65	F 3			Cow	Sheep				
E5		66	F# 3			Lion	Lion				
F5	F#5	67	G 3			Kick a can	Owl				
G5	G#5	68	G# 3	Shower	Laugh	Gear	Rooster				
A5	A#5	69	A 3	Thunder	Scream	Bubble	Bird				
B5		70	A# 3	Wind	Punch	Thunder	Frog				
C6		71	B 3	Stream	Heartbeat	Rain	Insect				
		72	C 4	Bubble	Footsteps	Wind	Door Squeak				
		73	C# 4	Feed		Scratch	Door Slam				
		74	D 4			Yo!	Dial Tone				
		75	D# 4			Go!	Alarm Bell				
		76	E 4			Get up!	Bicycle Horn				
		77	F 4			Whoow!	Siren				
		78	F# 4			Huaah!	Car Passing				
		79	G 4				Railroad Crossing				
		80	G# 4				Steam Engine Whistle				
		81	A 4				Train				
		82	A# 4				Helicopter				
		83	B 4				Jet Plane				
		84	C 5	Dog	Machine Gun	Uhl+Hit	UFO				
		85	C# 5	Horse Gallop	Laser Gun		Car Engine Ignition				
		86	D 5	Bird Tweet	Explosion		Car Horn				
		87	D# 5		Firework		Metallic Sound				
		88	E 5				Laser				
		89	F 5				Chime				
		90	F# 5				Cash register drawer				
		91	G 5	Maou			Barcode Scanner				
		92	G# 5				Zipper				
		93	A 5				Cuckoo Clock				
		94	A# 5			Clock Tick					
		95	B 5			Big Clock					
		96	C 6			Chau Gong					

Drum Kit List

	VoiceNo.	Keyboard		390	391	392	393	394	395
		Note No.	Note	Electronic Kit	Analog Kit	Dance Kit	Jazz Kit	Brush Kit	Symphony Kit
C1		36	C 1						
	C#1	37	C# 1						
D1		38	D 1						
	D#1	39	D# 1						
E1		40	E 1	Reverse Cymbal	Reverse Cymbal	Reverse Cymbal			
		41	F 1						
F1		42	F# 1	Hi Q 2	Hi Q 2	Hi Q 2			
	F#1	43	G 1	Snare Snappy Electronic	Snare Noisy 4	Snare Techno		Brush Slap 2	
G1		44	G# 1						
	G#1	45	A 1	Bass Drum H	Bass Drum H	Kick Techno Q			Bass Drum Soft L
A1		46	A# 1			Rim Gate			
	A#1	47	B 1	Bass Drum Rock	Bass Drum Analog L	Kick Techno L			Gran Cassa
B1		48	C 2	Bass Drum Gate	Bass Drum Analog H	Kick Techno	Bass Drum Jazz	Bass Drum Jazz	Gran Cassa Mute
	C#2	49	C# 2		Side Stick Analog	Side Stick Analog			
C2		50	D 2	Snare Noisy 2	Snare Analog 1	Snare Clap	Snare Jazz L	Brush Slap 3	Band Snare 1
	D#2	51	D# 2						
D2		52	E 2	Snare Noisy 3	Snare Analog 2	Snare Dry	Snare Jazz M	Brush Tap	Band Snare 2
	D#2	53	F 2	Tom Electronic 1	Tom Analog 1	Tom Analog 1	Tom Jazz 1	Tom Brush 1	Tom Jazz 1
F2		54	F# 2		Hi-Hat Close Analog 1	Hi-Hat Close Analog 3			
	F#2	55	G 2	Tom Electronic 2	Tom Analog 2	Tom Analog 2	Tom Jazz 2	Tom Brush 2	Tom Jazz 2
G2		56	G# 2		Hi-Hat Close Analog 2	Hi-Hat Close Analog 4			
	G#2	57	A 2	Tom Electronic 3	Tom Analog 3	Tom Analog 3	Tom Jazz 3	Tom Brush 3	Tom Jazz 3
A2		58	A# 2		Hi-Hat Open Analog	Hi-Hat Open Analog 2			
	A#2	59	B 2	Tom Electronic 4	Tom Analog 4	Tom Analog 4	Tom Jazz 4	Tom Brush 4	Tom Jazz 4
B2		60	C 3	Tom Electronic 5	Tom Analog 5	Tom Analog 5	Tom Jazz 5	Tom Brush 5	Tom Jazz 5
	C#3	61	C# 3		Cymbal Analog	Cymbal Analog			Hand Cymbal 1
C3		62	D 3	Tom Electronic 6	Tom Analog 6	Tom Analog 6	Tom Jazz 6	Tom Brush 6	Tom Jazz 6
	D#3	63	D# 3						Hand Cymbal 1 Short
D3		64	E 3						
	D#3	65	F 3						
F3		66	F# 3						
	F#3	67	G 3						
G3		68	G# 3		Cowbell Analog	Cowbell Analog			
	G#3	69	A 3						Hand Cymbal 2
A3		70	A# 3						
	A#3	71	B 3						Hand Cymbal 2 Short
B3		72	C 4						
	C#4	73	C# 4						
C4		74	D 4		Conga Analog H	Conga Analog H			
	D#4	75	D# 4		Conga Analog M	Conga Analog M			
D4		76	E 4		Conga Analog L	Conga Analog L			
	D#4	77	F 4						
F4		78	F# 4						
	F#4	79	G 4						
G4		80	G# 4						
	G#4	81	A 4						
A4		82	A# 4		Maracas 2	Maracas 2			
	A#4	83	B 4						
B4		84	C 5						
	C#5	85	C# 5						
C5		86	D 5						
	C#5	87	D# 5		Claves 2	Claves 2			
D5		88	E 5						
	D#5	89	F 5						
F5		90	F# 5	Scratch H	Scratch H	Scratch H			
	F#5	91	G 5	Scratch L	Scratch L	Scratch L			
G5		92	G# 5						
	G#5	93	A 5						
A5		94	A# 5						
	A#5	95	B 5						
B5		96	C 6						
C6									

Song List

Song No.	Song Name
DEMO	
001	Demo 1
002	Demo 2
003	Demo 3
TRADITIONAL	
004	Frère Jacques
005	Der Froschgesang
006	Aura Lee
007	London Bridge
008	Sur le pont d'Avignon
009	Old MacDonald Had a Farm
010	Nedelka
011	Sippin' Cider Through a Straw
012	Bury Me Not on the Lone Prairie
013	If You're Happy and You Know It
014	Greensleeves
015	Kalinka
016	Holdilia Cook
017	Red River Valley
FAVORITE	
018	Aloha Oe
019	Old Folks at Home
020	Santa Lucia
021	Beautiful Dreamer
022	Ring de Banjo
023	Funiculi Funicula
024	Largo (from the New World)
025	Brahms' Lullaby
026	Liebesträume Nr. 3
027	Pomp and Circumstance
028	Chanson du Toreador
029	Jupiter, the Bringer of Jollity
030	The Polovetsian Dances
031	Die Moldau
032	Salut d'Amour op. 12
033	Humoresques
034	Symphony No. 9 (from the New World - 4th movement)
INSTRUMENT MASTER	
035	Sicilienne / Fauré
036	Swan Lake
037	Grand March (Aida)
038	Serenade for Strings in C major, op. 48
039	Pizzicato Polka
040	Romance de Amor
041	Menuett BWV Anh. 114
042	Ave Verum Corpus
DUET	
043	Ten Little Indians
044	The Cuckoo
045	Close Your Hands, Open Your Hands
046	O du lieber Augustin
047	We Wish You a Merry Christmas
048	London Bridge
049	Scarborough Fair
050	Twinkle Twinkle Little Star
051	Im Mai
052	O Christmas Tree
053	Pop Goes the Weasel
054	Mary Had a Little Lamb
055	Row Row Row Your Boat
056	On Top of Old Smoky
FAVORITE WITH STYLE	
057	Amazing Grace
058	Oh! Susanna

Song No.	Song Name
059	Joy to the World
060	Little Brown Jug
061	Yankee Doodle
062	My Darling Clementine
063	Auld Lang Syne
064	My Bonnie
065	When the Saints Go Marching In
066	The Danube Waves
067	Battle Hymn of the Republic
068	I've Been Working on the Railroad
069	Grandfather's Clock
070	Bill Bailey (Won't You Please Come Home)
071	Down by the Riverside
072	Camptown Races
073	When Irish Eyes Are Smiling
074	Ave Maria
075	American Patrol
076	Valse Des Fleurs (From "The Nutcracker")
077	Frühlingsstimmen
PIANO REPERTOIRE	
078	Wenn ich ein Vöglein wär
079	Die Lorelei
080	Home Sweet Home
081	Scarborough Fair
082	My Old Kentucky Home
083	Loch Lomond
084	Silent Night
085	Deck the Halls
086	O Christmas Tree
087	Sonata Pathétique 2nd Adagio Cantabile
088	Ave Maria / J. S. Bach - Gounod
089	Jesus bleibet meine Freude
090	Prelude op. 28-15 "Raindrop"
091	Nocturne op. 9-2
092	Etude op. 10-3 "Chanson de l'adieu"
093	Romanze (Serenade K. 525)
094	Arabesque
095	La Chevaleresque
096	Für Elise
097	Turkish March
098	24 Preludes op. 28-7
099	Annie Laurie
100	Jeanie with the Light Brown Hair

- The scores for these built-in songs are included in the Song Book. However, 3 Songs (Song numbers 001-003) are excluded.
- Some Songs have been edited for length or for ease in learning, and may not be exactly the same as the original.

Song No.	Song Name
SPECIAL APPENDIX - RHYTHM TUTOR	
101	Rhythm Tutor 01
102	Rhythm Tutor 02
103	Rhythm Tutor 03
104	Rhythm Tutor 04
105	Rhythm Tutor 05
106	Rhythm Tutor 06
107	Rhythm Tutor 07
108	Rhythm Tutor 08
109	Rhythm Tutor 09
110	Rhythm Tutor 10
SPECIAL APPENDIX - CHORD STUDY*	
111	Chord Study 01
112	Chord Study 02
113	Chord Study 03
114	Chord Study 04
115	Chord Study 05
116	Chord Study 06
117	Chord Study 07
118	Chord Study 08
119	Chord Study 09
120	Chord Study 10
121	Chord Study 11
122	Chord Study 12
USER SONG	
123	User Song

- * You can hear and experience the sound of the chords used in a typical performance by playing back Song in this category. Song numbers 111-117 are very simple songs consisting of a single chord played in various positions, letting you listen to and master the chords one by one. On the other hand, Song numbers 118-122 consist of several chords strung together in patterns, for experiencing and understanding basic chord progressions.

Style List

Style No.	Style Name
POP & ROCK	
001	Brit Pop Rock
002	20s Electric Pop
003	20s Dance Pop
004	20s Diva Pop
005	Dancehall Pop
006	Viva Pop
007	8Beat Modern
008	Cool 8Beat
009	60s Guitar Pop
010	8Beat Adria
011	60s 8Beat
012	8Beat
013	Off Beat
014	60s Rock
015	Hard Rock
016	Rock Shuffle
017	8Beat Rock
018	16Beat
019	Pop Shuffle
020	Guitar Pop
021	16Beat Uptempo
022	Kool Shuffle
023	Hip Hop Light
BALLAD	
024	70s Glam Piano
025	Piano Ballad
026	Love Song
027	6/8 Modern EP
028	6/8 Slow Rock
029	Organ Ballad
030	Pop Ballad
031	16Beat Ballad
DANCE	
032	Euro Trance
033	DJ Mix 2017
034	Ibiza
035	Swing House
036	Club Dance
037	Club Latin
038	Garage 1
039	Garage 2
040	Techno Party
041	UK Pop
042	Hip Hop Groove
043	Hip Shuffle
044	Hip Hop Pop
045	70s Disco
046	Latin Disco
047	Saturday Night
048	Disco Hands
SWING & JAZZ	
049	Big Band Fast
050	Big Band Ballad
051	Jazz Club
052	Swing 1
053	Swing 2
054	Five/Four
055	Dixieland
056	Ragtime
R&B	
057	Soul
058	UK Soul
059	Detroit Pop
060	6/8 Soul
061	Croco Twist
062	Rock & Roll

Style No.	Style Name
063	Combo Boogie
064	6/8 Blues
LATIN	
065	Brazilian Samba
066	Bossa Nova
067	Forro
068	Sertanejo
069	Joropo
070	Parranda
071	Reggaeton
072	Tijuana
073	Paso Duranguense
074	Cumbia Grupera
075	Mambo
076	Salsa
077	Beguine
078	Reggae
WORLD	
079	Country Pop
080	Country Swing
081	Country 2/4
082	Bluegrass
083	Hawaiian
084	Celtic Dance
085	Scottish Reel
086	Saeidy
087	Wehda Saghira
088	Iranian Elec
089	Emarati
090	African Gospel Reggae
091	Makossa
092	Modern Afrobeat
093	High Life
094	Organ High Life
095	Igbo High Life
096	Soca
097	Azonto
098	Indian Pop
099	Bhangra
100	Bhajan
101	Bolly Mix
102	Tamil
103	Kerala
104	Goan Pop
105	Rajasthan
106	Dandiya
107	Qawwali
108	Folk Hills
109	Modern Dangdut 1
110	Modern Dangdut 2
111	Keroncong
112	Vietnamese Pop Ballad
113	Vietnamese 6/8 Ballad
114	Xi Qing Luo Gu
115	Yi Zu Min Ge
116	Jing Ju Jie Zou
BALLROOM	
117	Viennese Waltz
118	English Waltz
119	Slowfox
120	Foxtrot
121	Quickstep
122	Tango
123	Pasodoble
124	Samba
125	Cha-cha-cha
126	Rumba

Style No.	Style Name
127	Jive
TRAD. & WALTZ	
128	US March
129	6/8 March
130	German March
131	Polka Pop
132	Oberkrainer Polka
133	Tarantella
134	Showtune
135	Christmas Swing
136	Christmas Waltz
137	Italian Waltz
138	Swing Waltz
139	Jazz Waltz
140	Country Waltz
141	Oberkrainer Walzer
142	Musette
PIANIST	
143	Stride
144	Piano Swing
145	Arpeggio
146	Habanera
147	Slow Rock
148	8Beat Piano Ballad
149	6/8 Piano March
150	Piano Waltz

Effect Type List

Reverb Types

No.	Reverb Type	Description
01	Hall 1	Concert hall reverb.
02	Hall 2	
03	Hall 3	
04	Room 1	Small room reverb.
05	Room 2	
06	Stage 1	Reverb for solo instruments.
07	Stage 2	
08	Plate 1	Simulated steel plate reverb.
09	Plate 2	
10	Off	No effect.

Chorus Types

No.	Chorus Type	Description
01	Chorus 1	Conventional chorus program with rich, warm chorusing.
02	Chorus 2	
03	Chorus 3	
04	Flanger 1	This produces a rich, animated wavering effect in the sound.
05	Flanger 2	
06	Off	No effect.

NOTE

- The Reverb/Chorus types not included in the lists above may be called up as best-suited types when selecting some Songs or Styles.
- Selecting another Song or Style will reset the Reverb/Chorus type.

Specifications

Product Name		Digital Keyboard	
Size/Weight	Dimensions (W × D × H)		940 mm × 317 mm × 104 mm (37" x 12-1/2" x 4-1/8")
	Weight		4.0 kg (not including batteries) (8 lb, 13 oz)
Control Interface	Keyboard	Number of Keys	61
	Display	Type	LCD display
		Language	English
	Panel	Language	English
Voices	Tone Generation	Tone Generation Technology	AWM Stereo Sampling
	Polyphony	Number of Polyphony (max.)	32
	Preset	Number of Voices	392 Voices + 18 drum/SFX kits
Effects	Types	Reverb	9 types
		Chorus	5 types
		Master EQ	6 presets
		Ultra-Wide Stereo	3 types
	Functions	Panel Sustain	Yes
Duo		Yes	
Accompaniment Styles	Preset	Number of Styles	150
		Fingering	Smart Chord, Multi finger
		Style Control	ACMP ON/OFF, SYNC START, START/STOP, INTRO/ENDING/rit., MAIN/AUTO FILL
	Other Features	One Touch Setting (OTS)	Yes
Songs (Audio not supported.)	Preset	Number of Preset Songs	122 (including 10 Rhythm Tutor and 12 Chord Study Songs)
	Recording	Number of Songs	1
		Number of Tracks	1
		Data Capacity	Approx. 300 notes
		Compatible Data Format	Original File Format
Function	Lesson		3-Step Lesson (1 LISTENING, 2 TIMING, 3 WAITING), A-B Repeat, Rhythm Tutor, Chord Study
	Overall Controls	Metronome	Yes
		Tempo Range	11–280 (Tap Tempo: 32–280)
		Transpose	-12 to 0, 0 to +12
		Tuning	427.0–440.0–453.0 Hz (approx. 0.2 Hz increments)
Miscellaneous	PIANO Button	Yes ([PORTABLE GRAND] button)	
Quiz	Sound Quiz		Yes
	Memory Quiz		Yes (Melody mode, Random mode)
Connectivity	DC IN		12 V
	Headphones/Output		Standard stereo phone jack (Headphone/OUTPUT combined use)
	Sustain Pedal		Yes
	AUX IN		Stereo mini jack
Sound System	Amplifiers		2.5 W + 2.5 W
	Speakers		12 cm × 2
Power Supply	Power Supply	AC Adaptor	PA-130 or an equivalent recommended by Yamaha
		Batteries	"AA" size alkaline (LR6), manganese (R6) or Ni-MH rechargeable batteries (sold separately) × 6
	Power Consumption		6 W (When using PA-130 AC adaptor)
	Auto Power Off		Yes (time is adjustable)
Included Accessories			Owner's Manual Online Member Product Registration Music rest AC adaptor * (PA-130 or an equivalent recommended by Yamaha) * May not be included depending on your area. Please check with your Yamaha dealer.
Separately Sold Accessories (May not be available depending on your area.)			Headphones: HPH-50/HPH-100/HPH-150 Foot switch: FC4A/FC5 AC adaptor: Users within U.S. or Europe: PA-130 or an equivalent recommended by Yamaha Others: PA-3C, PA-130 or an equivalent Keyboard stand: L-2C Keyboard bag: SC-KB630

* The contents of this manual apply to the latest specifications as of the publishing date. To obtain the latest manual, access the Yamaha website then download the manual file. Since specifications, equipment or separately sold accessories may not be the same in every locale, please check with your Yamaha dealer.

Index

A

AC adaptor	5
Auto Accompaniment.....	23
Auto Power Off.....	6
AUX IN	31

B

Background Music	19
Battery.....	5
Battery type	6

C

Chord Study	22
Continuous playback	19

D

Demo	18
Drum Kit List.....	42
Duo mode	17

E

Effects	16
Effect Type List	47
Ending	24

F

Fill-in	24
Fingering Type.....	25
Foot switch.....	7, 9
Function settings	32

G

Grade	21
Grand Piano.....	9, 14

H

Headphones	7, 9
------------------	------

I

Initialization.....	35
Intro	24

L

Lesson	21
LISTEN	21

M

Main.....	24
Master Volume.....	7
Memory Quiz.....	28
Metronome.....	8, 15
Music Rest.....	7

N

NUM LOCK	10, 32
----------------	--------

O

OTS (One Touch Setting)	9, 14
-------------------------------	-------

P

Pedal.....	7
Phrase Recording.....	29
Piano.....	9, 14
Power Requirements	5

Q

Quiz.....	28
-----------	----

R

Recording.....	29
Rhythm Tutor.....	28
rit. (ritardando).....	24

S

Scoring	28
SFX KIT	14
SFX Kit List.....	41
SHIFT function.....	8
Smart Chord Key	25
Song.....	10, 18
Song List.....	45
Sound effects.....	14
Sound Quiz	28
Specifications.....	48
Split point.....	23, 32
Standby/On.....	6
Style	10, 23
Style List	46
Sustain.....	7, 9
SYNC START.....	23

T

Tap	15
Tempo.....	15
Time Signature	15
TIMING	21
Transpose.....	32
Troubleshooting.....	36
Tuning	32

V

Voice	10, 14
Voice List	38
Volume (master).....	7

W

WAITING.....	21
--------------	----

