

ARRAY FRAME HAF2-2112(W) Owner's Manual

EN



*Thank you for choosing this Yamaha product.
Please read this manual carefully before using it in a speaker installation.
Keep the manual in safe place for future reference.*

Package Contents

HAF2-2112(W)

- 3-1101 Angle indicator plates (3 pcs.)
- 3-1104 Suspension plate (1 pc.)
- 3-0235 M10-40mm button head socket screws (8 pcs.)
- 2-1432 M10 flat washers (10 pcs.)
- 3-0112 M10 L-key wrench (1 pc.)

NOTE

- Use only the eye bolts included with the speaker unit.
- For information on load limits and the strength of the eyebolt, refer to the owner's manual of the speaker.
- The load limits and strength of the suspension plate are 114.5 kg (maximum).

Installation Instructions

1. Flip the speakers upside down. Remove the existing speaker screws.
2. Determine the splay angle of the speaker and the holes to use on the front joiner plate.
3. Install two angle indicator plates on the bottom (facing up) of the speakers. Use the two slots of the angle indicator plate for the rear inserts of the speaker, as shown in the illustration. Install another angle indicator plate on the front inserts using the corresponding holes for the appropriate splay angle. The hole closest to the center is 0 degrees and the farthest is 15 degrees. Use the provided M10 button head screws and washers.
4. Slowly flip the speaker assembly so that the tops of the speakers are facing up.
5. Install an angle indicator plate on the top front insert using the provided screws and flat washers. Use the same holes as the bottom front joiner plate.
6. Install a suspension plate on the rear insert using the slot on the joiner plate, as shown in the illustration. Tighten the screws permanently.
7. Install the M10 eye bolts to the top of the speaker as shown in the illustration. For a tight pack, use the two outer holes of the speaker; for maximum splay, use the center holes of the speakers.
8. Use the bar of the suspension plate and the two eye bolts to suspend the speaker cluster assembly.
9. For steep tilt angles, move the suspension plate to the bottom rear of the cluster and use the suspension bar as a pull back point.

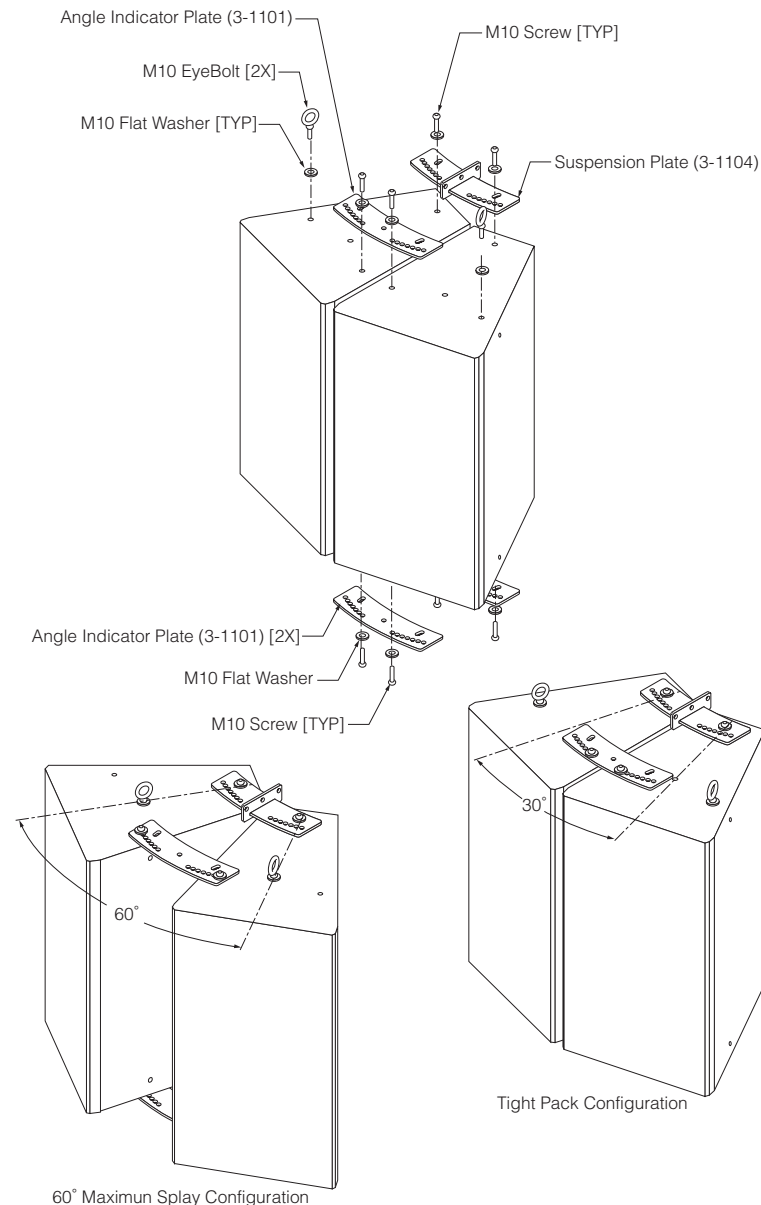

PRECAUTIONS

PLEASE READ CAREFULLY BEFORE PROCEEDING

* Please keep this manual in a safe place for future reference.

CAUTION

Always follow the basic precautions listed below to avoid the possibility of physical injury to you or others, or damage to the device or other property. These precautions include, but are not limited to, the following:



- Before doing any installation or construction work, consult with an installation expert.
- Make sure that the surface this bracket is being mounted on has the strength to handle the weight of both the speaker and this bracket.
- Use bolts and nuts as well as washers for installation and tighten them firmly so that the speaker is secure and does not move.
- Always loosen the corresponding screw before adjusting the angle or direction of the speaker. Never force this adjustment with the screw still tightened.
- Some fittings may deteriorate over extended periods of time due to wear and/or corrosion. For optimum safety, the installation should be checked thoroughly at regular intervals.

Yamaha cannot be held responsible for damage or injury caused by insufficient strength of the support structure or improper installation.

* Illustrations herein are for explanatory purposes only, and may not match actual appearance during operation.

* Company names and product names herein are trademarks or registered trademarks of their respective companies.

* Specifications and descriptions in this owner's manual are for information purposes only. Yamaha Corp. reserves the right to change or modify products or specifications at any time without prior notice. Since specifications, equipment or options may not be the same in every locale, please check with your Yamaha dealer.

Dimensions

3-1101 Angle Indicator Plate

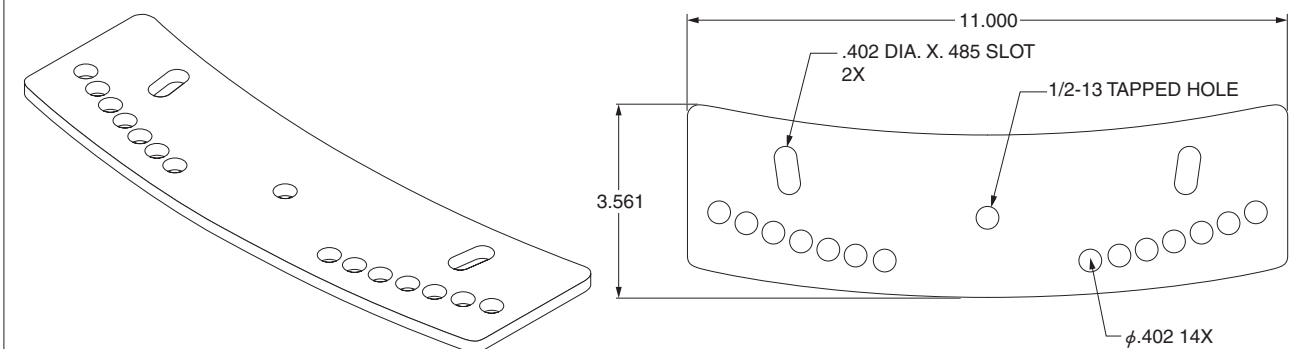

3-1104 Suspension Plate

