



Portable Grand

DGX-230

YPG-235

Owner's Manual



SPECIAL MESSAGE SECTION

This product utilizes batteries or an external power supply (adapter). DO NOT connect this product to any power supply or adapter other than one described in the manual, on the name plate, or specifically recommended by Yamaha.

WARNING: Do not place this product in a position where anyone could walk on, trip over, or roll anything over power or connecting cords of any kind. The use of an extension cord is not recommended! If you must use an extension cord, the minimum wire size for a 25' cord (or less) is 18 AWG. NOTE: The smaller the AWG number, the larger the current handling capacity. For longer extension cords, consult a local electrician.

This product should be used only with the components supplied or; a cart, rack, or stand that is recommended by Yamaha. If a cart, etc., is used, please observe all safety markings and instructions that accompany the accessory product.

SPECIFICATIONS SUBJECT TO CHANGE:

The information contained in this manual is believed to be correct at the time of printing. However, Yamaha reserves the right to change or modify any of the specifications without notice or obligation to update existing units.

This product, either alone or in combination with an amplifier and headphones or speaker/s, may be capable of producing sound levels that could cause permanent hearing loss. DO NOT operate for long periods of time at a high volume level or at a level that is uncomfortable. If you experience any hearing loss or ringing in the ears, you should consult an audiologist.

IMPORTANT: The louder the sound, the shorter the time period before damage occurs.

Some Yamaha products may have benches and / or accessory mounting fixtures that are either supplied with the product or as optional accessories. Some of these items are designed to be dealer assembled or installed. Please make sure that benches are stable and any optional fixtures (where applicable) are well secured BEFORE using. Benches supplied by Yamaha are designed for seating only. No other uses are recommended.

NOTICE:

Service charges incurred due to a lack of knowledge relating to how a function or effect works (when the unit is operating as designed) are not covered by the manufacturer's warranty, and are therefore the owners responsibility. Please study this manual carefully and consult your dealer before requesting service.

ENVIRONMENTAL ISSUES:

Yamaha strives to produce products that are both user safe and environmentally friendly. We sincerely believe that our products and the production methods used to produce them, meet these goals. In keeping with both the letter and the spirit of the law, we want you to be aware of the following:

Battery Notice:

This product MAY contain a small non-rechargeable battery which (if applicable) is soldered in place. The average life span of this type of battery is approximately five years. When replacement becomes necessary, contact a qualified service representative to perform the replacement.

This product may also use "household" type batteries. Some of these may be rechargeable. Make sure that the battery being charged is a rechargeable type and that the charger is intended for the battery being charged.

When installing batteries, do not mix batteries with new, or with batteries of a different type. Batteries MUST be installed correctly. Mismatches or incorrect installation may result in overheating and battery case rupture.

Warning:

Do not attempt to disassemble, or incinerate any battery. Keep all batteries away from children. Dispose of used batteries promptly and as regulated by the laws in your area. Note: Check with any retailer of household type batteries in your area for battery disposal information.

Disposal Notice:

Should this product become damaged beyond repair, or for some reason its useful life is considered to be at an end, please observe all local, state, and federal regulations that relate to the disposal of products that contain lead, batteries, plastics, etc. If your dealer is unable to assist you, please contact Yamaha directly.

NAME PLATE LOCATION:

The name plate is located on the bottom of the product. The model number, serial number, power requirements, etc., are located on this plate. You should record the model number, serial number, and the date of purchase in the spaces provided below and retain this manual as a permanent record of your purchase.

Model

Serial No.

Purchase Date

PLEASE KEEP THIS MANUAL

92-BP (bottom)

FCC INFORMATION (U.S.A.)

1. IMPORTANT NOTICE: DO NOT MODIFY THIS UNIT!

This product, when installed as indicated in the instructions contained in this manual, meets FCC requirements. Modifications not expressly approved by Yamaha may void your authority, granted by the FCC, to use the product.

2. IMPORTANT: When connecting this product to accessories and/or another product use only high quality shielded cables. Cable/s supplied with this product MUST be used. Follow all installation instructions. Failure to follow instructions could void your FCC authorization to use this product in the USA.

3. NOTE: This product has been tested and found to comply with the requirements listed in FCC Regulations, Part 15 for Class "B" digital devices. Compliance with these requirements provides a reasonable level of assurance that your use of this product in a residential environment will not result in harmful interference with other electronic devices. This equipment generates/uses radio frequencies and, if not installed and used according to the instructions found in the users manual, may cause interference harmful to the operation of other electronic devices. Compliance with FCC regulations does

not guarantee that interference will not occur in all installations. If this product is found to be the source of interference, which can be determined by turning the unit "OFF" and "ON", please try to eliminate the problem by using one of the following measures:

Relocate either this product or the device that is being affected by the interference.

Utilize power outlets that are on different branch (circuit breaker or fuse) circuits or install AC line filter/s.

In the case of radio or TV interference, relocate/reorient the antenna. If the antenna lead-in is 300 ohm ribbon lead, change the lead-in to co-axial type cable.

If these corrective measures do not produce satisfactory results, please contact the local retailer authorized to distribute this type of product. If you can not locate the appropriate retailer, please contact Yamaha Corporation of America, Electronic Service Division, 6600 Orangethorpe Ave, Buena Park, CA90620

The above statements apply ONLY to those products distributed by Yamaha Corporation of America or its subsidiaries.

* This applies only to products distributed by YAMAHA CORPORATION OF AMERICA.

(class B)

IMPORTANT NOTICE FOR THE UNITED KINGDOM Connecting the Plug and Cord

IMPORTANT. The wires in this mains lead are coloured in accordance with the following code:

BLUE : NEUTRAL
BROWN : LIVE

As the colours of the wires in the mains lead of this apparatus may not correspond with the coloured markings identifying the terminals in your plug proceed as follows:

The wire which is coloured BLUE must be connected to the terminal which is marked with the letter N or coloured BLACK.

The wire which is coloured BROWN must be connected to the terminal which is marked with the letter L or coloured RED.

Making sure that neither core is connected to the earth terminal of the three pin plug.

• This applies only to products distributed by Yamaha-Kemble Music (U.K.) Ltd.

(2 wires)

COMPLIANCE INFORMATION STATEMENT (DECLARATION OF CONFORMITY PROCEDURE)

Responsible Party : Yamaha Corporation of America

Address : 6600 Orangethorpe Ave., Buena Park, Calif.
90620

Telephone : 714-522-9011

Type of Equipment : Digital Keyboard

Model Name : DGX-230/YPG-235

This device complies with Part 15 of the FCC Rules.

Operation is subject to the following two conditions:

- 1) this device may not cause harmful interference, and
- 2) this device must accept any interference received including interference that may cause undesired operation.

See user manual instructions if interference to radio reception is suspected.

* This applies only to products distributed by YAMAHA CORPORATION OF AMERICA.

(FCC DoC)

OBSERVERA!

Apparaten kopplas inte ur växelströmskällan (nätet) så länge som den är ansluten till vägguttaget, även om själva apparaten har stängts av.

ADVARSEL: Netspændingen til dette apparat er IKKE afbrudt, så længe netledningen sidder i en stikkontakt, som er tændt — også selvom der er slukket på apparatets afbryder.

VAROITUS: Laitteen toisiopiiriin kytketty käyttökyltkin ei irroita koko laitetta verkosta.

(standby)

Entsorgung leerer Batterien (nur innerhalb Deutschlands)

Leisten Sie einen Beitrag zum Umweltschutz. Verbrauchte Batterien oder Akkumulatoren dürfen nicht in den Hausmüll. Sie können bei einer Sammelstelle für Altbatterien bzw. Sondermüll abgegeben werden. Informieren Sie sich bei Ihrer Kommune.

(battery)

PRECAUTIONS

PLEASE READ CAREFULLY BEFORE PROCEEDING

* Please keep this manual in a safe place for future reference.



WARNING

Always follow the basic precautions listed below to avoid the possibility of serious injury or even death from electrical shock, short-circuiting, damages, fire or other hazards. These precautions include, but are not limited to, the following:

Power supply/AC power adaptor

- Only use the voltage specified as correct for the instrument. The required voltage is printed on the name plate of the instrument.
- Use the specified adaptor (PA-150 or an equivalent recommended by Yamaha) only. Using the wrong adaptor can result in damage to the instrument or overheating.
- Check the electric plug periodically and remove any dirt or dust which may have accumulated on it.
- Do not place the AC adaptor cord near heat sources such as heaters or radiators, and do not excessively bend or otherwise damage the cord, place heavy objects on it, or place it in a position where anyone could walk on, trip over, or roll anything over it.

Do not open

- Do not open the instrument or attempt to disassemble the internal parts or modify them in any way. The instrument contains no user-serviceable parts. If it should appear to be malfunctioning, discontinue use immediately and have it inspected by qualified Yamaha service personnel.

Water warning

- Do not expose the instrument to rain, use it near water or in damp or wet conditions, or place containers on it containing liquids which might spill into any openings. If any liquid such as water seeps into the instrument, turn off the power immediately and unplug the power cord from the AC outlet. Then have the instrument inspected by qualified Yamaha service personnel.
- Never insert or remove an electric plug with wet hands.

Fire warning

- Do not put burning items, such as candles, on the unit. A burning item may fall over and cause a fire.

If you notice any abnormality

- If the AC adaptor cord or plug becomes frayed or damaged, or if there is a sudden loss of sound during use of the instrument, or if any unusual smells or smoke should appear to be caused by it, immediately turn off the power switch, disconnect the adaptor plug from the outlet, and have the instrument inspected by qualified Yamaha service personnel.



CAUTION

Always follow the basic precautions listed below to avoid the possibility of physical injury to you or others, or damage to the instrument or other property. These precautions include, but are not limited to, the following:

Power supply/AC power adaptor

- When removing the electric plug from the instrument or an outlet, always hold the plug itself and not the cord.
- Unplug the AC power adaptor when not using the instrument, or during electrical storms.
- Do not connect the instrument to an electrical outlet using a multiple-connector. Doing so can result in lower sound quality, or possibly cause overheating in the outlet.

Battery

- Always make sure all batteries are inserted in conformity with the +/- polarity markings. Failure to do so might result in overheating, fire, or battery fluid leakage.
- Always replace all batteries at the same time. Do not use new batteries together with old ones. Also, do not mix battery types, such as alkaline batteries with manganese batteries, or batteries from different makers, or different types of batteries from the same maker, since this can cause overheating, fire, or battery fluid leakage.
- Do not dispose of batteries in fire.

- Do not attempt to recharge batteries that are not intended to be charged.
- When the batteries run out, or if the instrument is not to be used for a long time, remove the batteries from the instrument to prevent possible leakage of the battery fluid.
- Keep batteries away from children.
- If the batteries do leak, avoid contact with the leaked fluid. If the battery fluid should come in contact with your eyes, mouth, or skin, wash immediately with water and consult a doctor. Battery fluid is corrosive and may possibly cause loss of sight or chemical burns.

Location

- Do not expose the instrument to excessive dust or vibrations, or extreme cold or heat (such as in direct sunlight, near a heater, or in a car during the day) to prevent the possibility of panel disfiguration or damage to the internal components.
- Do not use the instrument in the vicinity of a TV, radio, stereo equipment, mobile phone, or other electric devices. Otherwise, the instrument, TV, or radio may generate noise.
- Do not place the instrument in an unstable position where it might accidentally fall over.

- Before moving the instrument, remove all connected adaptor and other cables.
- When setting up the product, make sure that the AC outlet you are using is easily accessible. If some trouble or malfunction occurs, immediately turn off the power switch and disconnect the plug from the outlet. Even when the power switch is turned off, electricity is still flowing to the product at the minimum level. When you are not using the product for a long time, make sure to unplug the power cord from the wall AC outlet.
- Use only the stand specified for the instrument. When attaching the stand or rack, use the provided screws only. Failure to do so could cause damage to the internal components or result in the instrument falling over.

Connections

- Before connecting the instrument to other electronic components, turn off the power for all components. Before turning the power on or off for all components, set all volume levels to minimum. Also, be sure to set the volumes of all components at their minimum levels and gradually raise the volume controls while playing the instrument to set the desired listening level.

Maintenance

- When cleaning the instrument, use a soft, dry cloth. Do not use paint thinners, solvents, cleaning fluids, or chemical-impregnated wiping cloths.

Handling caution

- Do not insert a finger or hand in any gaps on the instrument.
- Never insert or drop paper, metallic, or other objects into the gaps on the panel or keyboard. If this happens, turn off the power immediately and unplug the power cord from the AC outlet. Then have the instrument inspected by qualified Yamaha service personnel.
- Do not place vinyl, plastic or rubber objects on the instrument, since this might discolor the panel or keyboard.
- Do not rest your weight on, or place heavy objects on the instrument, and do not use excessive force on the buttons, switches or connectors.
- Do not use the instrument/device or headphones for a long period of time at a high or uncomfortable volume level, since this can cause permanent hearing loss. If you experience any hearing loss or ringing in the ears, consult a physician.

Saving data

Saving and backing up your data

- The panel settings and some other types of data are not retained in memory when you turn off the power to the instrument. Save data you want to keep to the Registration Memory (page 73.) Saved data may be lost due to malfunction or incorrect operation. Save important data to an external device such as a computer (pages 84).

Yamaha cannot be held responsible for damage caused by improper use or modifications to the instrument, or data that is lost or destroyed.

Always turn the power off when the instrument is not in use.

When using a power adaptor, even when the power switch is in the "STANDBY" position, electricity is still flowing to the instrument at the minimum level. When you are not using the instrument for a long time, make sure you unplug the AC power adaptor from the wall AC outlet.

Make sure to discard used batteries according to local regulations.

The illustrations and LCD screens as shown in this manual are for instructional purposes only, and may appear somewhat different from those on your instrument.

● Trademarks

- Windows is a registered trademark of Microsoft® Corporation in the United States and other countries.
- The company names and product names in this Manual are the trademarks or registered trademarks of their respective companies.

Copyright Notice

The following is the title, credits and copyright notices for the song pre-installed in this electronic keyboard:

Mona Lisa
from the Paramount Picture CAPTAIN CAREY, U.S.A.
Words and Music by Jay Livingston and Ray Evans
Copyright © 1949 (Renewed 1976) by Famous Music Corporation
International Copyright Secured All Rights Reserved

Composition Title : Against All Odds
Composer's Name : Collins 0007403
Copyright Owner's Name : EMI MUSIC PUBLISHING LTD
AND HIT & RUN MUSIC LTD

All Rights Reserved, Unauthorized copying, public performance and broadcasting are strictly prohibited.

Can't Help Falling In Love
from the Paramount Picture BLUE HAWAII
Words and Music by George David Weiss,
Hugo Peretti and Luigi Creatore
Copyright © 1961; Renewed 1989 Gladys Music (ASCAP)
Worldwide Rights for Gladys Music Administered by Cherry Lane
Music Publishing Company, Inc.
International Copyright Secured All Rights Reserved

This product incorporates and bundles computer programs and contents in which Yamaha owns copyrights or with respect to which it has license to use others' copyrights. Such copyrighted materials include, without limitation, all computer software, style files, MIDI files, WAVE data, musical scores and sound recordings. Any unauthorized use of such programs and contents outside of personal use is not permitted under relevant laws. Any violation of copyright has legal consequences. **DON'T MAKE, DISTRIBUTE OR USE ILLEGAL COPIES.**

Copying of the commercially available musical data including but not limited to MIDI data and/or audio data is strictly prohibited except for your personal use.

Panel Logos



GM System Level 1

"GM System Level 1" is an addition to the MIDI standard which ensures that any GM-compatible music data can be accurately played by any GM-compatible tone generator, regardless of manufacturer. The GM mark is affixed to all software and hardware products that support GM System Level.



XGlite

As its name implies, "XGlite" is a simplified version of Yamaha's high-quality XG tone generation format. Naturally, you can play back any XG song data using an XGlite tone generator. However, keep in mind that some songs may play back differently compared to the original data, due to the reduced set of control parameters and effects.



USB

USB is an abbreviation for Universal Serial Bus. It is a serial interface for connecting a computer with peripheral Devices. It allows "hot swapping" (connecting peripheral devices while the power to the computer is on).



STYLE FILE

The Style File Format is Yamaha's original style file format which uses a unique conversion system to provide high-quality automatic accompaniment based on a wide range of chord types.

*Congratulations and thank you for purchasing
the Yamaha DGX-230/YPG-235 Portable Grand!*

*Please read this owner's manual carefully before using the instrument
in order to take full advantage of its various features.*

*Make sure to keep this manual in a safe and handy place even after you finish reading,
and refer to it often when you need to better understand an operation or function.*

Included Accessories

The DGX-230/YPG-235 package includes the following items. Please check that you have them all.

- Owner's Manual
- Music rest
- Accessory CD-ROM

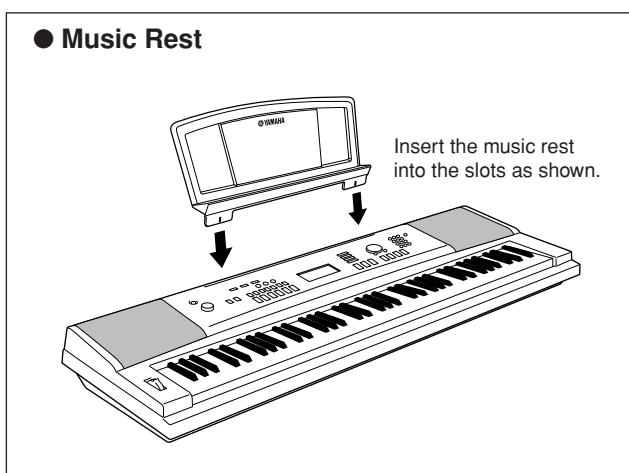

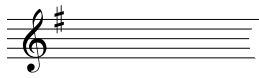

Special Features of the DGX-230/YPG-235

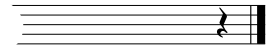

Graded Soft Touch keyboard

Just as on an actual piano, the lower keys are heavy in touch and the higher keys are light, with soft touch of digital keyboard for beginners.

■ Play a Variety of Instrument Voices ▶ Page 14

The instrument voice that sounds when you play the keyboard can be changed to violin, flute, harp, or any of an extensive range of voices. You can change the mood of a song written for piano, for example, by using violin to play it instead. Experience a whole new world of musical variety.



■ Play Along with Styles ▶ Page 19

Want to play with full accompaniment? Try the auto-accompaniment Styles. The accompaniment styles provide the equivalent of a full backing band covering a wide variety of styles from waltzes to 8-beat to euro-trance ... and much more. Select a style that matches the music you want to play, or experiment with new styles to expand your musical horizons.



■ Performance assistant technology ▶ Page 29

Play along with a song on the instrument's keyboard and produce a perfect performance every time ... even if you play wrong notes! All you have to do is play on the keyboard—alternately on the left- and right-hand ranges of the keyboard, for example—and you'll sound like a pro as long as you play in time with the music.

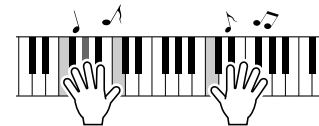

■ Learning Music is Fun ▶ Page 36

This instrument includes a range of songs covering a variety of genres that are enjoyable to listen to, or to play along with. You can start practicing with just one hand, and you can even practice at your own tempo, one note at a time as slowly as you like, until you are able to play at full speed. Song playback will automatically follow your tempo. You can also use songs you have downloaded from the Internet for lessons, so your musical resources are essentially unlimited! The instrument will even evaluate and grade your performance for you!

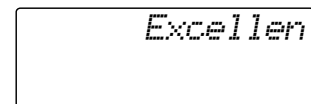

Contents

Copyright Notice	6
Panel Logos	6
Included Accessories	7
Special Features of the DGX-230/YPG-235	8
Setting Up	10
Power Requirements	10
Connecting Headphones (PHONES/OUTPUT Jack).....	11
Connecting a Footswitch (SUSTAIN Jack)	11
Connecting to a Computer (USB Terminal)	11
Turning the Power On.....	11
Panel Controls and Terminals	12
Front Panel	12
Rear Panel.....	13
Quick Guide	
Try Playing a Variety of Instrument Voices	14
Select and Play a Voice—MAIN	14
Play Two Voices Simultaneously—DUAL.....	15
Play Different Voices with the Left and Right Hands —SPLIT	16
Play the Grand Piano Voice.....	17
Fun Sounds	18
Drum Kits	18
Sound Effects.....	18
Playing Styles	19
Select a Style Rhythm.....	19
Play Along with a Style	20
Playing Auto-accompaniment Chords.....	24
Using Songs	25
Select and Listen to a Song	25
Song Fast Forward, Fast Reverse, and Pause.....	26
Types of Songs	28
The Easy Way to Play Piano	29
CHORD Type—Play with Both Hands	30
CHD/FREE Type—Applying the Chord Type to the Left Hand Only	32
Change the Song Tempo.....	35
Select a Song For a Lesson	36
Lesson 1—Waiting	36
Lesson 2—Your Tempo	39
Lesson 3—Minus One	40
Practice Makes Perfect—Repeat and Learn.....	41
Play Using the Music Database	42
Change a Song's Style	43
Listen to the DEMO Song for Easy Song Arranger.....	43
Using the Easy Song Arranger	43
Record Your Own Performance	45
Track Configuration.....	45
Recording Procedure	45
Song Clear—Deleting User Songs	48
Track Clear—Deleting a Specified Track from a User Song.....	48
Backup and Initialization	49
Backup	49
Initialization	49
Basic Operation and Displays	50
Basic Operation	50
Display Items	52

Reference

Adding Effects	53
Harmony.....	53
Adding Reverb	54
Adding Chorus	55
Handy Performance Features	56
The Metronome.....	56
Tap Start	58
Touch Response Sensitivity.....	58
Panel Sustain.....	59
Pitch Bend.....	59
Pitch Controls.....	60
One Touch Setting	61
Adjusting the Harmony Volume.....	62
Select an EQ Setting for the Best Sound.....	62
Style (Auto-accompaniment) Functions	63
Pattern Variation (Sections)	63
Adjusting the Style Volume	65
Setting the Split Point.....	65
Play a Style with Chords but No Rhythm (Stop Accompaniment)	66
Playing Styles Using the Entire Keyboard.....	66
Loading Style Files.....	67
Chord Basics.....	68
Looking Up Chords Using the Chord Dictionary	70
Song Settings	71
Song Volume.....	71
A-B Repeat.....	71
Muting Independent Song Parts.....	72
Change the Melody Voice.....	72
Memorize Your Favorite Panel Settings	73
Saving to the Registration Memory	73
Recalling a Registration Memory	74
The Functions	75
Selecting and Setting Functions.....	75
Connecting to a Computer	78
What Is MIDI?	78
Connecting a Personal Computer.....	79
Transferring Performance Data to and from a Computer....	80
Remote Control of MIDI Devices.....	81
Initial Send	82
Transferring Data between the Computer and Instrument...	82
Accessory CD-ROM Installation Guide	85
Important Notices about the CD-ROM	85
CD-ROM Contents	86
System Requirements.....	87
Software Installation.....	87
Appendix	
Troubleshooting.....	92
Scores	94
Voice List	100
Drum Kit List	104
Style List	106
Music Database List	107
Songs Provided On the Supplied CD-ROM	108
Effect Type List	109
MIDI Implementation Chart	110
MIDI Data Format	112
Specifications.....	115
Index.....	116



Setting Up

Be sure to do the following operations **BEFORE** turning on the power.

Power Requirements

Although the instrument will run either from an optional AC adaptor or batteries, Yamaha recommends use of an AC adaptor whenever possible. An AC adaptor is more environmentally friendly than batteries and does not deplete resources.

■ Using an AC Power Adaptor

- 1 Make sure that the [STANDBY/ON] switch of the instrument is set to STANDBY.

⚠ WARNING

- Use the specified adaptor (PA-150 or an equivalent recommended by Yamaha) only. The use of other adaptors may result in irreparable damage to both the adaptor and the instrument.

- 2 Connect the AC adaptor to the power supply jack.
- 3 Plug the AC adaptor into an AC outlet.

⚠ CAUTION

- Unplug the AC Power Adaptor when not using the instrument, or during electrical storms.

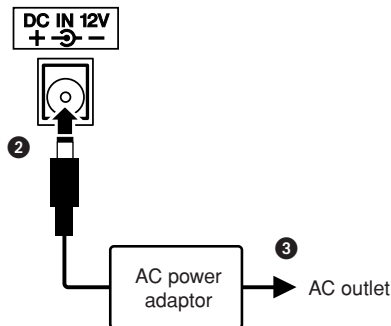

■ Using Batteries

- 1 Open the battery compartment cover located on the instrument's bottom panel.
- 2 Insert the six new batteries, being careful to follow the polarity markings on the inside of the compartment.
- 3 Replace the compartment cover, making sure that it locks firmly in place.

NOTE

- Connecting the AC power adaptor automatically supplies power from the adaptor and overrides battery power, even when batteries are installed.

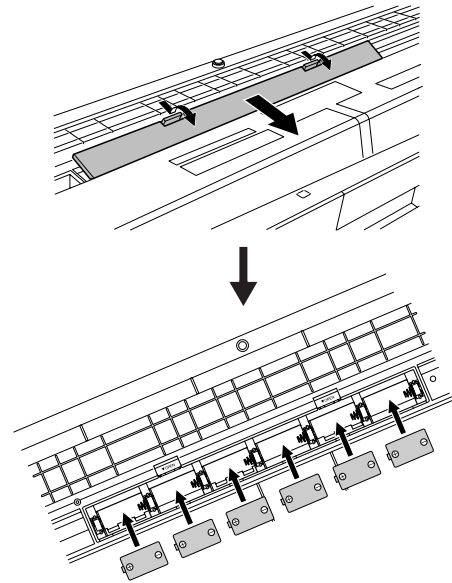

For battery operation the instrument requires six 1.5V "D" size, R20P (LR20) or equivalent batteries. (Alkaline batteries are recommended.) When battery power becomes too low for proper operation, make sure to replace all batteries, following the precautions listed below.

If necessary, also make sure to save all important User data (see page 49), since custom panel settings are lost when the batteries are removed.

⚠ CAUTION

- Use only manganese or alkaline batteries for this instrument. Other types of batteries (including rechargeable batteries) may exhibit a sudden drop in power when the batteries are low, possibly resulting in a loss of flash memory data.
- Be sure to install the batteries in the same direction, maintaining the correct polarity (as shown). Incorrect battery installation may result in heat, fire and/or leaking of corrosive chemicals.
- When the batteries run down, replace them with a complete set of six new batteries. NEVER mix old and new batteries. Do not use different kinds of batteries (e.g. alkaline and manganese) at the same time.
- If the instrument will not be used for an extended period of time, remove the batteries to prevent possible fluid leakage.
- Please use the power adaptor when transferring data to flash memory. Batteries (including rechargeable types) can be drained rapidly by this type of operation. If the batteries do become drained during a data transfer, both the data being transferred and the data currently in the transfer destination will be lost.

Make all necessary connections below **BEFORE** turning the power on.

Connecting Headphones (PHONES/OUTPUT Jack)

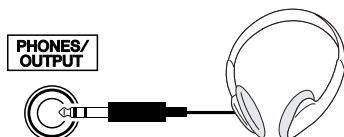

The DGX-230/YPG-235 speakers are automatically shut off when a plug is inserted into this jack.

The PHONES/OUTPUT jack also functions as an external output. You can connect the PHONES/OUTPUT jack to a keyboard amplifier, stereo system, mixer, tape recorder, or other line-level audio device to send the instrument's output signal to that device.

WARNING

- Avoid listening with the headphones at high volume for long periods of time; doing so may not only result in ear fatigue, it may be damaging to your hearing.

CAUTION

- To prevent damage to the speakers, set the volume of the external devices at the minimum setting before connecting them. Failure to observe these cautions may result in electric shock or equipment damage. Also, be sure to set the volumes of all devices at their minimum levels and gradually raise the volume controls while playing the instrument to set the desired listening level.

Connecting a Footswitch (SUSTAIN Jack)

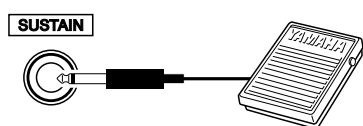

The sustain function lets you produce a natural sustain as you play by pressing a footswitch. Plug the Yamaha FC4 or FC5 footswitch into this jack and use it to switch sustain on and off.

NOTE

- Make sure that the footswitch plug is properly connected to the SUSTAIN jack before turning on the power.
- Do not press the footswitch while turning the power on. Doing this changes the recognized polarity of the footswitch, resulting in reversed footswitch operation.

Connecting to a Computer (USB Terminal)

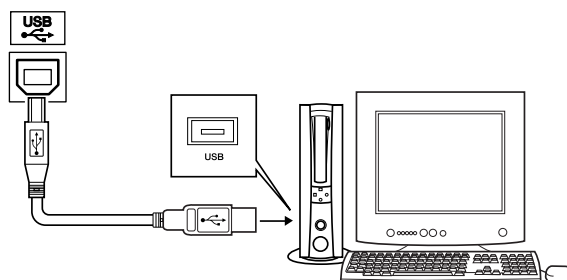

Connect the instrument's USB terminal to the USB terminal of a computer, and you can transfer performance data and song files between the two (page 79). To use the USB data-transfer features you'll need to do the following:

- First, make sure the **POWER** switch on the instrument is set to **OFF**, then use an **AB** type USB cable to connect the instrument to the computer. After making the connections, turn on the power of the instrument.
- Install the **USB-MIDI** driver on your computer.

Installation of the USB-MIDI driver is described on page 87.

NOTE

- Make sure to purchase a quality USB cable at a musical instrument store, computer store or electrical appliance store.

Turning the Power On

Turn down the volume by turning the [MASTER VOLUME] control to the left and press the [STANDBY/ON] switch to turn on the power. Press the [STANDBY/ON] switch again to turn the power OFF.

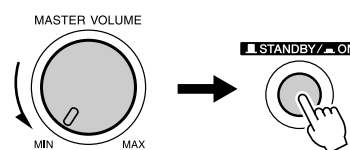

Backup data in the flash memory is loaded to the instrument when the power is turned on. If no backup data exists on flash memory, all instrument settings are restored to the initial factory defaults when the power is turned on.

CAUTION

- Even when the switch is in the "STANDBY" position, electricity is still flowing to the instrument at the minimum level. When you are not using the instrument for a long time, make sure you unplug the AC power adaptor from the wall AC outlet, and/or remove the batteries from the instrument.

CAUTION

- Never attempt to turn the power off when a "WRITING!" message is shown in the display. Doing so can damage the flash memory and result in data loss.



Panel Controls and Terminals

Front Panel

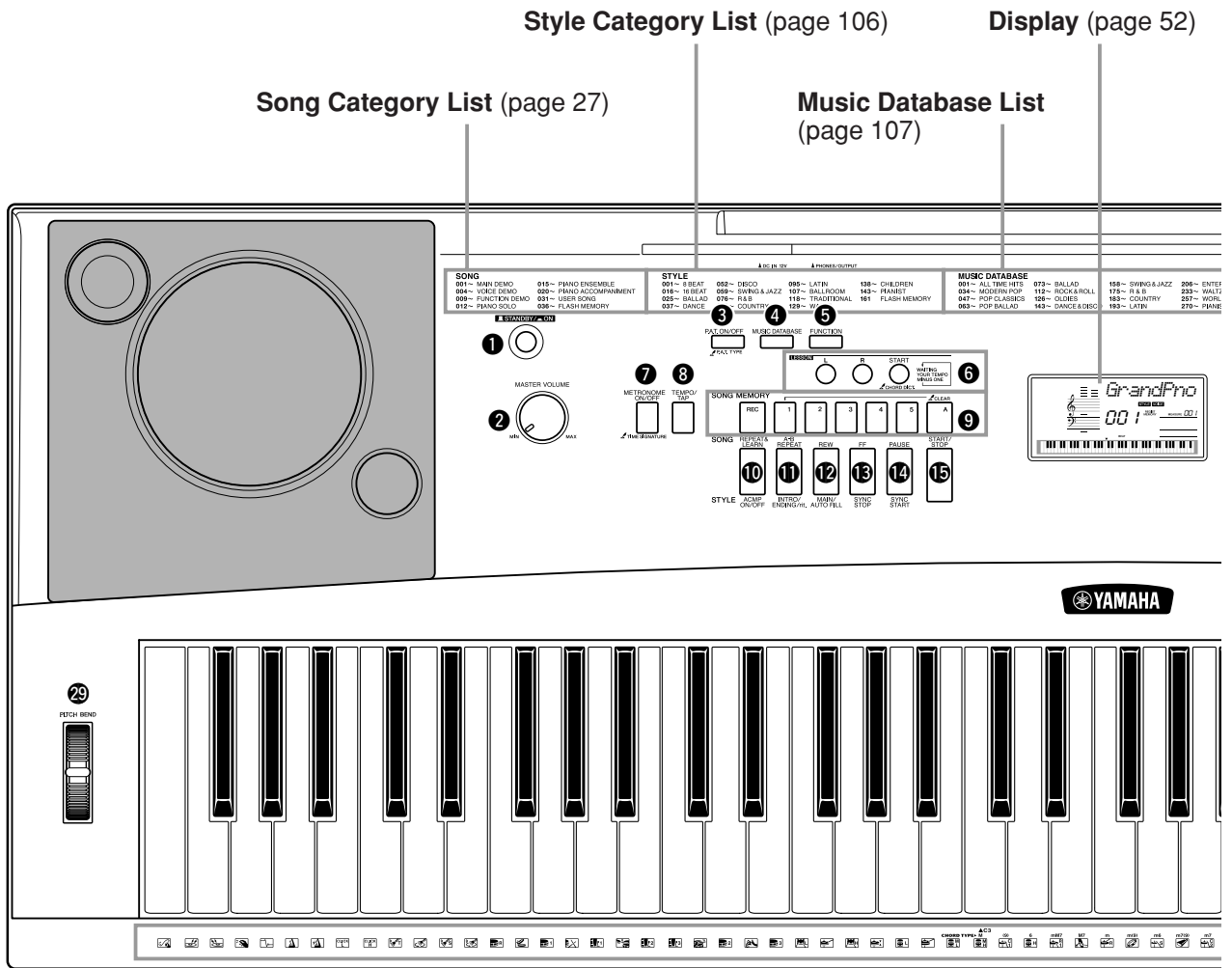

Front Panel

- ① [STANDBY/ON] switch page 11
- ② [MASTER VOLUME] control pages 11, 50
- ③ [P.A.T. ON/OFF] button page 30
- ④ [MUSIC DATABASE] button page 42
- ⑤ [FUNCTION] button page 75
- ⑥ LESSON [L], [R], [START] buttons . page 37
- ⑦ [METRONOME ON/OFF] button page 56
- ⑧ [TEMPO/TAP] button page 35
- ⑨ SONG MEMORY
[REC], [1]–[5], [A] buttons page 45
- ⑩ [REPEAT & LEARN]/
[ACMP ON/OFF] button pages 41, 20
- ⑪ [A-B REPEAT]/
[INTRO/ENDING/rit.] button pages 71, 64
- ⑫ [REW]/
[MAIN/AUTO FILL] button pages 26, 64
- ⑬ [FF]/
[SYNC STOP] button pages 26, 64
- ⑭ [PAUSE]/
[SYNC START] button pages 26, 63
- ⑮ [START/STOP] button pages 19, 26, 51
- ⑯ [SONG] button page 25
- ⑰ [EASY SONG ARRANGER]
button page 43
- ⑱ [STYLE] button page 19
- ⑲ [VOICE] button page 14
- ⑳ Dial pages 51, 75
- ㉑ CATEGORY [▲] and [▼]
buttons pages 51, 75

Voice Category List (page 100)

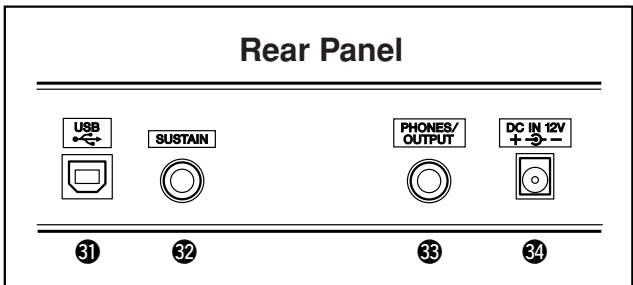
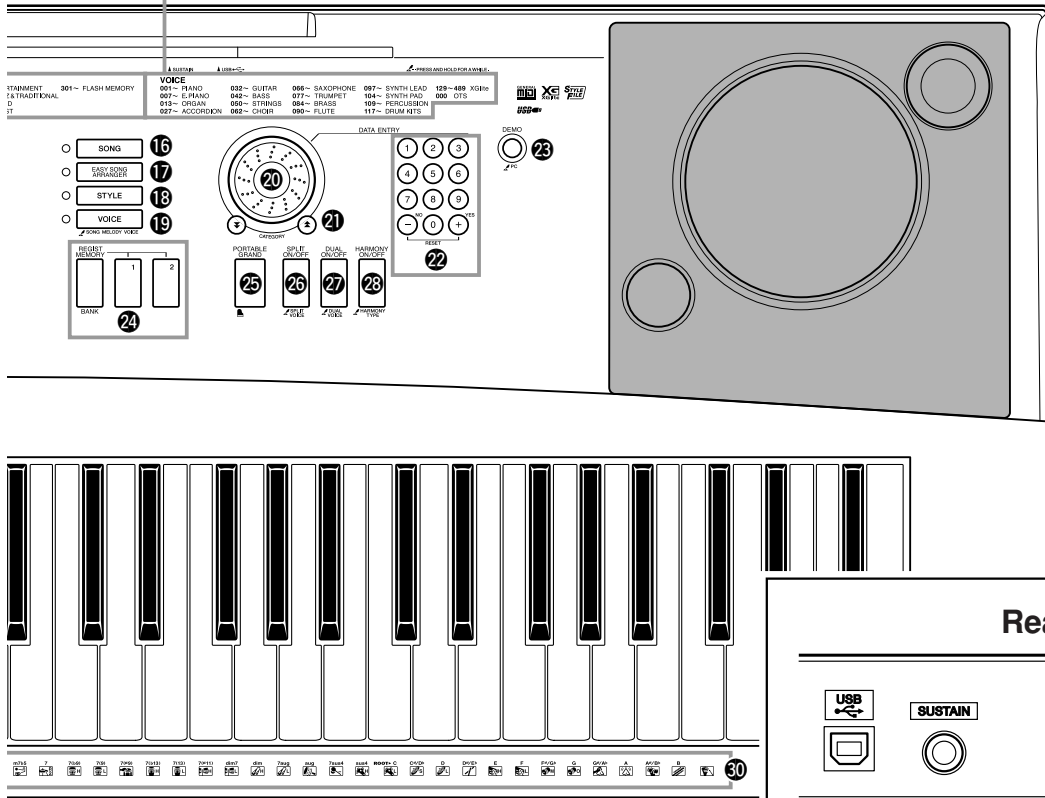

Rear Panel

- 22 Number buttons [0]–[9],
[+] and [-] buttons..... pages 51, 75
- 23 [DEMO] button..... page 26
- 24 REGIST MEMORY
[MEMORY/BANK],
[1], [2] buttons page 73
- 25 [PORTABLE GRAND] button page 17
- 26 [SPLIT ON/OFF] button page 16
- 27 [DUAL ON/OFF] button page 15
- 28 [HARMONY ON/OFF] button page 53
- 29 PITCH BEND wheel page 59
- 30 Drum Kit page 18
The illustrations next to each key indicate the drum and percussion instruments assigned to the keys when “Standard Kit 1” is selected.

- 31 USB terminalpages 11, 79
- 32 SUSTAIN jack..... page 11
- 33 PHONES/OUTPUT jack page 11
- 34 DC IN 12V jack..... page 10



Try Playing a Variety of Instrument Voices

In addition to piano, organ, and other “standard” keyboard instruments, this instrument has a large range of voices that includes guitar, bass, strings, sax, trumpet, drums and percussion, sound effects ... a wide variety of musical sounds.

Select and Play a Voice—MAIN

This procedure selects the main voice you will play on the keyboard.

1 Press the [VOICE] button.

The voice number and name will be displayed.

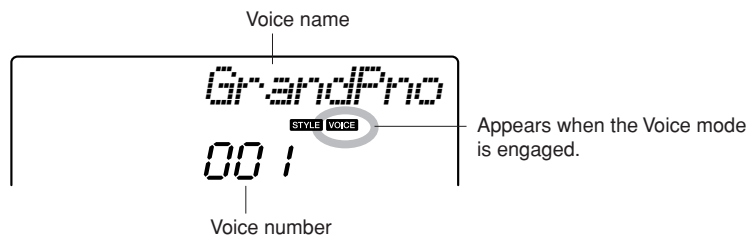
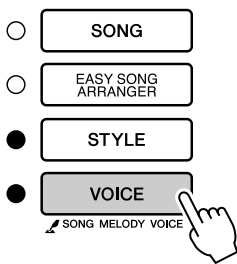

2 Select the voice you want to play.

While watching the displayed voice name rotate the dial. The available voices will be selected and displayed in sequence. The voice selected here becomes the main voice.

For this example select the “092 Flute” voice.

NOTE

- You can also select the voice using the CATEGORY [\blacktriangle] and [\blacktriangledown] buttons after pressing the [VOICE] button. (page 51)

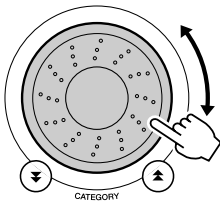

3 Play the keyboard.

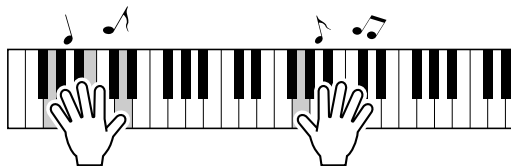

Try selecting and playing a variety of voices.

Play Two Voices Simultaneously—DUAL

You can select a second voice which will play in addition to the main voice when you play the keyboard. The second voice is known as the “dual” voice.

1 Press the [DUAL ON/OFF] button.

The [DUAL ON/OFF] button turns the dual voice on or off. When turned on the dual voice icon will appear in the display. The currently selected dual voice will sound in addition to the main voice when you play the keyboard.

NOTE

- The dual voice feature cannot be used during a song lesson (page 36).

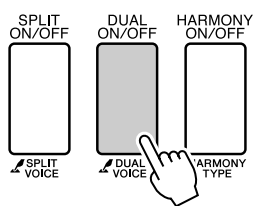

Dual voice icon

2 Press and hold the [DUAL ON/OFF] button for longer than a second.

“D.VOICE” appears in the display for a few seconds, then the currently selected dual voice will be displayed.

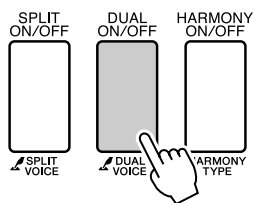

Hold for longer than a second

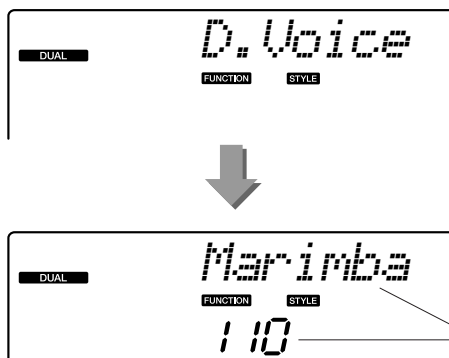

The currently selected dual voice

NOTE

- You can also select the Dual Voice display by pressing the [FUNCTION] button and then using the CATEGORY [▲] and [▼] buttons to select the “D.Voice” item.

3 Select the desired dual voice.

Watch the displayed dual voice and rotate the dial until the voice you want to use is selected. The voice selected here becomes the dual voice. For this example try selecting the “109 Vibraphone” voice.

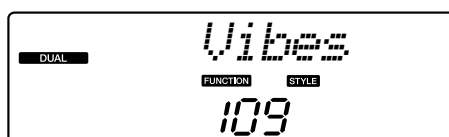
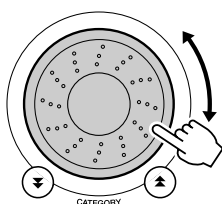

4 Play the keyboard.

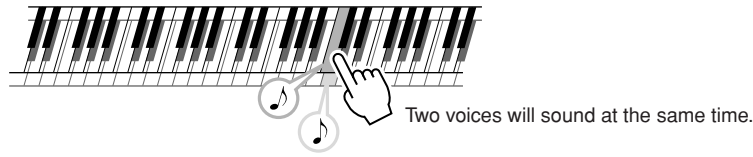

Try selecting and playing a range of dual voices.

Play Different Voices with the Left and Right Hands—SPLIT

In the split mode you can play different voices to the left and right of the keyboard “split point”. The main and dual voices can be played to the right of the split point, while the voice played to the left of the split point is known as the “split voice”. The split point setting can be changed as required (page 65).

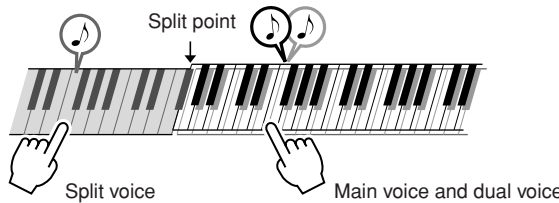

1 Press the [SPLIT ON/OFF] button.

The [SPLIT ON/OFF] button turns the split voice on or off. When turned on the split voice icon will appear in the display. The currently selected split voice will sound to the left of the keyboard split point.

NOTE

- The split voice feature cannot be used during a song lesson (page 36).

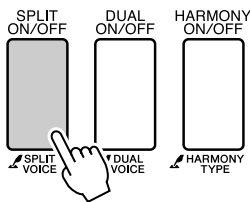

2 Press and hold the [SPLIT ON/OFF] button for longer than a second.

“S.VOICE” appears in the display for a few seconds, then the currently selected split voice will be displayed.

NOTE

- You can also select the Split Voice display by pressing the [FUNCTION] button and then using the CATEGORY [▲] and [▼] buttons to select the “S.Voice” item.

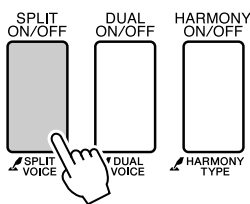

Hold for longer than a second

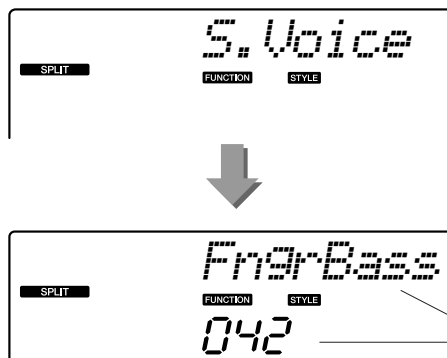

3 Select the desired split voice.

Watch the displayed split voice and rotate the dial until the voice you want to use is selected. The voice selected here becomes the split voice which will play to the left of the keyboard split point. For this example try selecting the “033 Folk Guitar” voice.

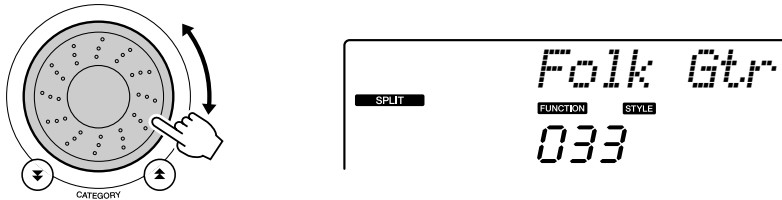

4 Play the keyboard.

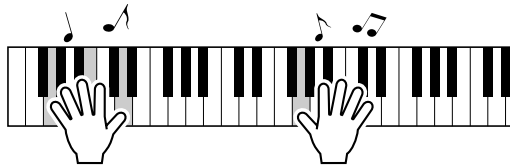

Try selecting and playing a range of split voices.

Play the Grand Piano Voice

When you just want to play piano, all you have to do is press one convenient button.

Press the [PORTABLE GRAND] button.

The “001 Grand Piano” voice will be selected.

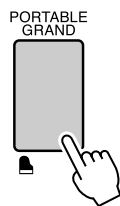

NOTE

- When you press the [PORTABLE GRAND] button all settings other than touch sensitivity are turned off. The dual and split voices will also be turned off, so only the Grand Piano voice will play over the entire keyboard.



Fun Sounds

This instrument includes a range of drum kits and unique sound effects you can use for entertainment. Laughter, babbling brooks, jet fly-bys, eerie effects, and much more. These sounds can be a great way to enhance the mood at parties.

Drum Kits

Drum kits are collections of drum and percussion instruments. When you select a violin or other normal instrument main voice, for example, all keys produce the sound of the same violin, only at different pitches. If you select a drum kit as the main voice, however, each key produces the sound of a different drum or percussion instrument.

◆ Drum Kit Selection Procedure → (refer to steps 1 and 2 on page 14)

- 1 Press the [VOICE] button.
- 2 Use the dial to select “117 Std.Kit1”.
- 3 Try out each key and enjoy the drum and percussion sounds!

Try out each key and enjoy the drum and percussion sounds! Don't forget the black keys! You'll hear a triangle, maracas, bongos, drums ... a comprehensive variety of drum and percussion sounds. For details on the instruments included in the drum kit voices (voice numbers 117 to 128), see the “Drum Kit List” on page 104.

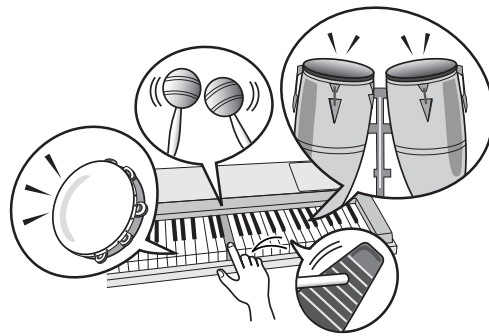

Sound Effects

The sound effects are included in the drum kit voice group (voice numbers 127 and 128). When either of these voices are selected you will be able to play a range of sound effects on the keyboard.

◆ Sound Effect Selection Procedure → (refer to steps 1 and 2 on page 14)

- 1 Press the [VOICE] button.
- 2 Use the dial to select “128 SFX Kit2”.
- 3 Try out each key and enjoy the sound effects!

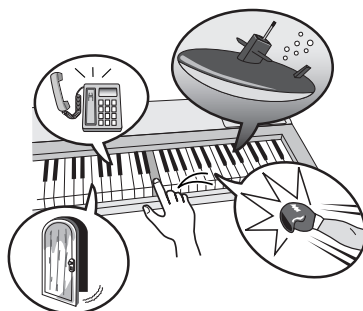

As you try out the various keys you'll hear the sound of a submarine, a telephone bell, a creaking door, laughter, and many other useful effects. “127 SFX Kit1” includes lightning, running water, dogs barking, and others. Some keys do not have assigned sound effects, and will therefore produce no sound. For details on the instruments included in the SFX kit voices, see “SFX Kit 1” and “SFX Kit 2” in the “Drum Kit List” on page 104.





Playing Styles

This instrument has an auto accompaniment feature that produces accompaniment (rhythm + bass + chords) in the style you choose to match chords you play with your left hand. You can select from 160 different styles covering a range of musical genres and time signatures (see page 106 for a complete list of the available styles). In this section we'll learn how to use the auto accompaniment features.

Select a Style Rhythm

Most styles includes a rhythm part. You can select from a wide variety of rhythmic types—rock, blues, Euro trance, and many, many more. Let's begin by listening to just the basic rhythm. The rhythm part is played using percussion instruments only.

1 Press the [STYLE] button.

The style number and name will appear in the display.

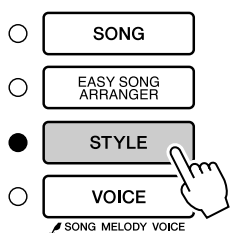

This icon appears when a style number and name is displayed.

2 Select a style.

Use the dial to select the style you want to use. A list of all the available styles is provided on page 106.

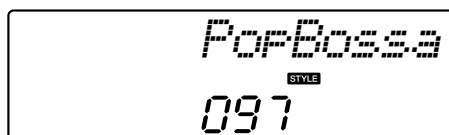
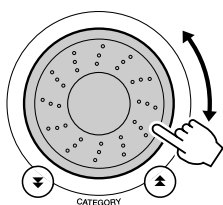

NOTE

• An external style file loaded into style number 161 can be selected and used in the same way as the internal styles. The style file must be loaded into style number 161 after transferring it to the instrument from a computer. For details, refer to the section "Loading Style Files" on page 67.

3 Press the [START/STOP] button.

The style rhythm will start playing. Press the [START/STOP] button a second time when you want to stop playback.

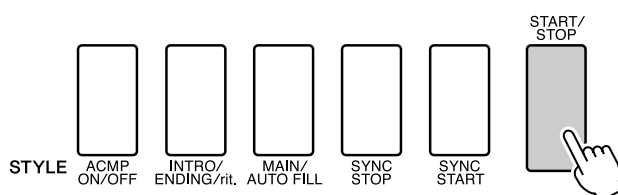

NOTE

• Style numbers 131, 143–160 have no rhythm part and therefore no rhythm will play if you use them for the above example. For these styles first turn auto accompaniment on as described on page 20, press the [START/STOP] button, and the accompaniment bass and chord parts will begin playing when you play a key to the left of the keyboard split point.

Play Along with a Style

You learned how to select a style rhythm on the preceding page.

Here we'll see how to add bass and chord accompaniment to the basic rhythm to produce a full, rich accompaniment that you can play along with.

1 Press the [STYLE] button and select the desired style.

2 Turn automatic accompaniment on.

Press the [ACMP ON/OFF] button.

Pressing this button a second time will turn automatic accompaniment off.

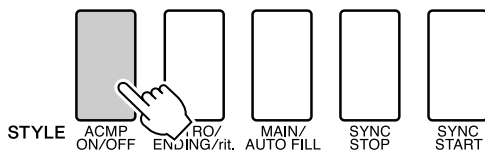

This icon appears when automatic accompaniment is on.

● **When automatic accompaniment is on ...**

The area of the keyboard to the left of the split point (54 : F#2) becomes the "auto accompaniment region" and is used only for specifying the accompaniment chords.

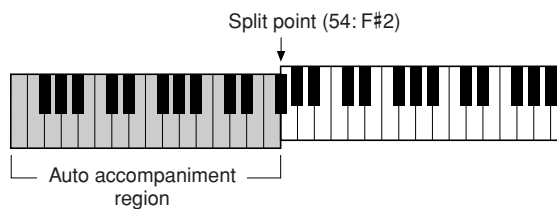

NOTE

- The keyboard split point can be changed as required: refer to page 65.

3 Turn sync start on.

Press the [SYNC START] button to turn the sync start function on.

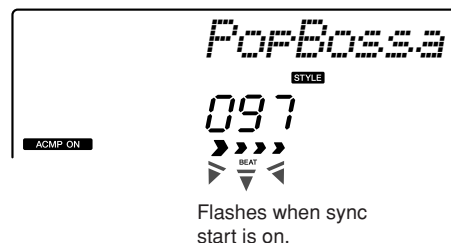
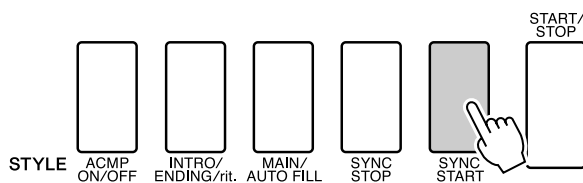

Flashes when sync start is on.

When sync start is on, the bass and chord accompaniment included in a style will start playing as soon as you play a note to left of the keyboard split point. Press the button a second time to turn the sync start function off.

4 Play a left-hand chord to start the style.

You can still “play” chords even if you don’t actually know any chords. This instrument will recognize even a single note as a chord. Try playing from one to three notes at the same time to the left of the split point. The accompaniment will change according to the left-hand notes you play.

Try this!

Scores for some chord progressions are provided on page 22. These examples should help you get a feel for what types of chord progressions sound good with the styles.

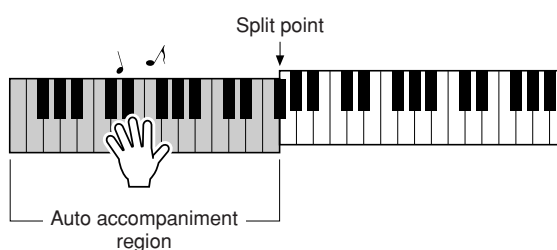

5 Play a variety of left-hand chords while playing a melody with your right hand.

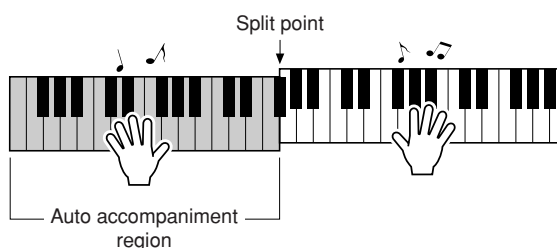

6 Press the [START/STOP] button to stop style playback when you’re done.

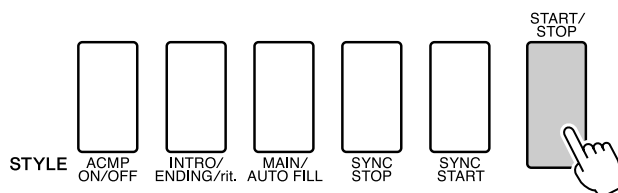

You can switch style “sections” to add variety to the accompaniment. Refer to “Pattern Variation (Sections)” on page 63.

Styles Are More Fun When You Understand Chords

Chords, created by playing multiple notes at the same time, are the basis for harmonic accompaniment. In this section we'll take a look at sequences of different chords played one after another, or "chord sequences". Since each chord has its own unique "color"—even if it's different fingerings of the same chord—the chords you choose to use in your chord progressions have a huge influence on the overall feel of the music you play.

On page 20 you learned how to play colorful accompaniments using styles. Chord progressions are vital to creating interesting accompaniments, and with a little chord know-how you should be able to take your accompaniments to a new level.

On these pages we'll introduce three easy-to-use chord progressions. Be sure to try them out with the instrument's accompaniment styles. The style will respond to the chord progression you play, effectively creating a complete song.

■ Playing the Chord Progressions

Play the scores with the left hand.

Before playing the scores follow steps 1 through 3 of "Play Along with a Style" on page 20.

* The scores provided here are not standard song scores, but rather simplified scores that indicate which notes to play to produce the chord progressions.

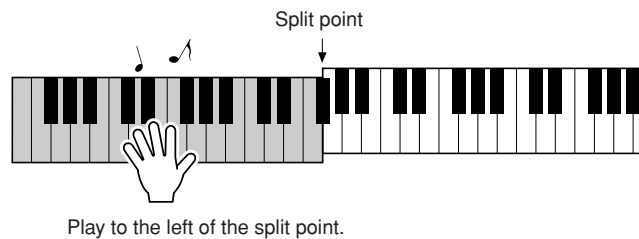

Recommended Style	041 Euro Trance
--------------------------	------------------------

—Dance music with simple chords—

Press the [INTRO/ENDING/rit.] button.

F	C	G	Am

This is a simple-but-effective chord progression. When you play through to the end of the score, start again from the beginning. When you're ready to stop playing press the [INTRO/ENDING/rit.] button and the auto accompaniment function will create a perfect ending.

Recommended Style **148 Piano Boogie**

—3-chord boogie-woogie—

Press the [INTRO/ENDING/rit.] button.

C F C

G F C

Press the [INTRO/ENDING/rit.] button.

This progression provides varied harmonic backing with just three chords. When you get a feel for the progression in the score, try changing the order of the chords!

Recommended Style **096 Bossa Nova**

—Bossa nova with jazz-style chords—

Press the [INTRO/ENDING/rit.] button.

Dm G7 CM7 FM7

Bm7^{b5} E7 Am A7

Press the [INTRO/ENDING/rit.] button.

This progression includes jazzy “two-five” (II-V) changes. Try playing it through several times. When you’re ready to stop playing press the [INTRO/ENDING/rit.] button.

Playing Auto-accompaniment Chords

There are two ways of playing auto-accompaniment chords:

- Easy Chords
- Standard Chords

The instrument will automatically recognize the different chord types. This function is called Multi Fingering.

Press the [ACMP ON/OFF] button to turn auto-accompaniment on (page 20). The keyboard to the left of the split point (default: 54/F#2) becomes the “accompaniment range”. Play the accompaniment chords in this area of the keyboard.

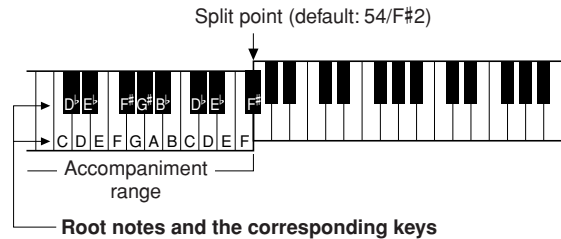

■ Easy Chords

This method lets you easily play chords in the accompaniment range of the keyboard using only one, two, or three fingers.

	<p>C</p> <ul style="list-style-type: none"> • To play a major chord Press the root note of the chord.
	<p>Cm</p> <ul style="list-style-type: none"> • To play a minor chord Press the root note together with the nearest black key to the left of it.
	<p>C7</p> <ul style="list-style-type: none"> • To play a seventh chord Press the root note together with the nearest white key to the left of it.
	<p>Cm7</p> <ul style="list-style-type: none"> • To play a minor seventh chord Press the root note together with the nearest white and black keys to the left of it (three keys altogether).

■ Standard Chords

This method lets you produce accompaniment by playing chords using normal fingerings in the accompaniment range of the keyboard.

● How to play Standard Chords [Example for “C” chords]

* Notes enclosed in parentheses () are optional; the chords will be recognized without them.



Using Songs

With this instrument the term “song” refers the data that makes up a piece of music. You can simply enjoy listening to the 30 internal songs, or use them with just about any of the many functions provided—the performance assistant technology feature, lessons, and more. The songs are organized by category.

In this section we’ll learn how to select and play songs, and briefly describe the 30 songs provided.

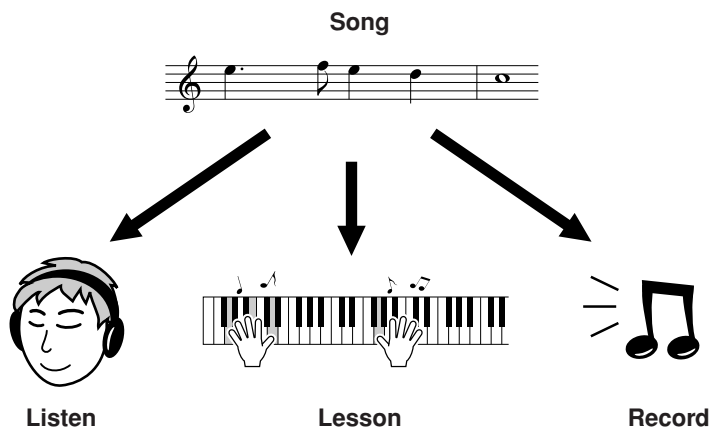

Select and Listen to a Song

1 Press the [SONG] button.

The song number and name will be displayed.
You can use the dial to select a different song.

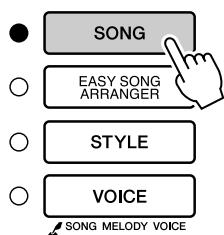

The currently selected song and number are displayed

2 Select a song.

Select a song after referring to the preset song category list on page 27.
Use the dial to select the song you want to listen to.

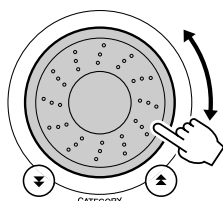

The song displayed here can be played

NOTE

- You can also play songs you have recorded yourself (User Songs) or songs that have been transferred to the instrument from a computer in the same way that you play the internal songs.

001–030	Built in Songs (see next page)
031–035	User Songs (Songs you record yourself).
036–	Songs transferred from a computer (pages 82–84)

3 Listen to the song.

Press the [START/STOP] button to begin playback of the selected song. You can stop playback at any time by pressing the [START/STOP] button again.

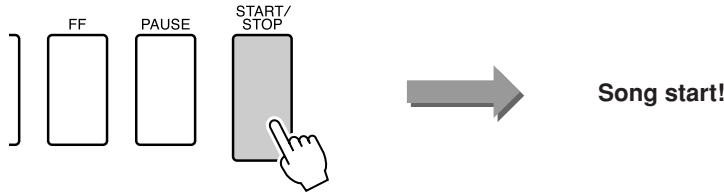

● **Using the [DEMO] button**

Press the [DEMO] button to play Songs 001–008 in sequence. Playback will repeat when the end of the sequence is reached, starting again from the first Song (001).

You can select a song by using the [-] and [+] buttons after pressing the [DEMO] button.

You can stop playback at any time by pressing the [DEMO] button.

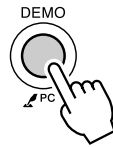

Song Fast Forward, Fast Reverse, and Pause

These are just like the transport controls on a cassette deck or CD player, letting you fast forward [FF], rewind [REW] and pause [PAUSE] playback of the song.

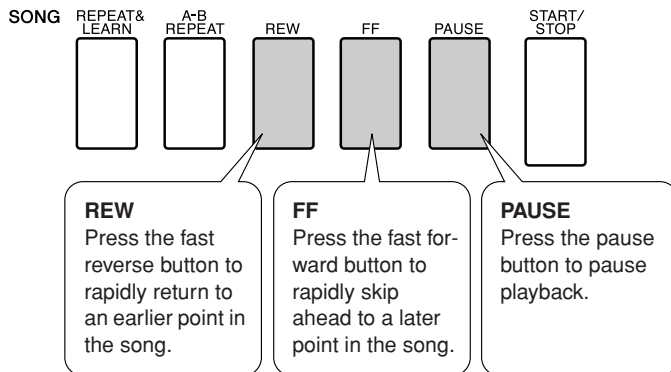

NOTE

• When an A-B repeat range is specified the fast reverse and forward function will only work within that range.

● Song List

These 30 songs include songs that effectively demonstrate the instrument's easy song arranger feature, songs that are ideally suited for use with the performance assistant technology feature, and more. The "Suggested Uses" column provides some ideas as to how the songs can most effectively be used.

Category	No.	Name	Suggested Uses
Main Demo	1 CHORD	JetSet	The songs in this category have been created to give you an idea of the advanced capabilities of this instrument. They're great for listening, or for use with the performance assistant technology feature.
	2 CHORD	Winter Serenade	
	3 CHORD	Take off	
Voice Demo	4 CHORD	Grand Piano Demo	These songs features some of the instrument's many useful voices. They make maximum use of the characteristics of each voice, and might serve as inspiration for your own compositions.
	5 CHORD	Sweet! Tenor Sax Demo	
	6 CHORD	Cool! Rotor Organ Demo	
	7 CHORD	Cool! Galaxy Electric Piano Demo	
Function Demo	8 CHORD	Modern Harp & Sweet! Soprano Demo	Use these songs to experience some of the instrument's advanced features: song number 9 for the easy song arranger, and songs 10 and 11 for the performance assistant technology feature.
	9 CHORD	Hallelujah Chorus	
	10 CHORD	Ave Maria	
Piano Solo	11 CHORD	Nocturne op.9-2	These piano solo pieces are ideally suited for use as lesson songs.
	12	For Elise	
	13	Maple Leaf Rag	
Piano Ensemble	14	Jeanie with the Light Brown Hair	A selection of piano ensemble songs that are also well suited for use as lesson songs.
	15 CHORD	Amazing Grace	
	16 CHORD	Mona Lisa (Jay Livingston and Ray Evans)	
	17	Piano Concerto No.21 2nd mov.	
	18 CHORD	Scarborough Fair	
Piano Accompaniment	19 CHORD	Old Folks at Home	When you need to practice backing (accompaniment) patterns, these are the songs to do it with. This is ability you'll need if you're invited to play with a band. These songs allow you to practice backing parts one hand at a time, which can be the easiest way to master this important skill.
	20 CHORD	Ac Ballad (Against All Odds: Collins 0007403)	
	21 CHORD	Ep Ballad	
	22 CHORD	Boogie Woogie	
	23 CHORD	Rock Piano	
	24 CHORD	Salsa	
	25 CHORD	Country Piano	
	26 CHORD	Gospel R&B	
	27 CHORD	Medium Swing	
	28 CHORD	Jazz Waltz	
	29 CHORD	Medium Bossa	
30 CHORD	Slow Rock (Can't Help Falling In Love: George David Weiss, Hugo Peretti and Luigi Creatore)		

CHORD : Includes chord data.

The scores for the internal songs—except for songs 1–11, and song 16, 20 and 30 which is copyrighted, are provided in the Song Book on the CD-ROM. The scores for songs 9–11 are provided in this manual.

Some of the classic and/or traditional songs have been edited for length or for ease in learning, and may not be exactly the same as the original.

Types of Songs

The following three types of songs can be used by the DGX-230/YPG-235.

- **Preset Songs (the 30 songs built into the instrument).....Song numbers 001–030.**
- **User Songs (recordings of your own performances)Song numbers 031–035.**
- **External song files (song data transferred from a computer*) ... Song numbers 036–.**

* The Accessory CD-ROM includes a selection of 70 MIDI songs. See page 83 for instructions on how to transfer the songs to the instrument.

The chart below shows the basic DGX-230/YPG-235 processes flow for using the preset songs, user songs, and external song files—from storage to playback.

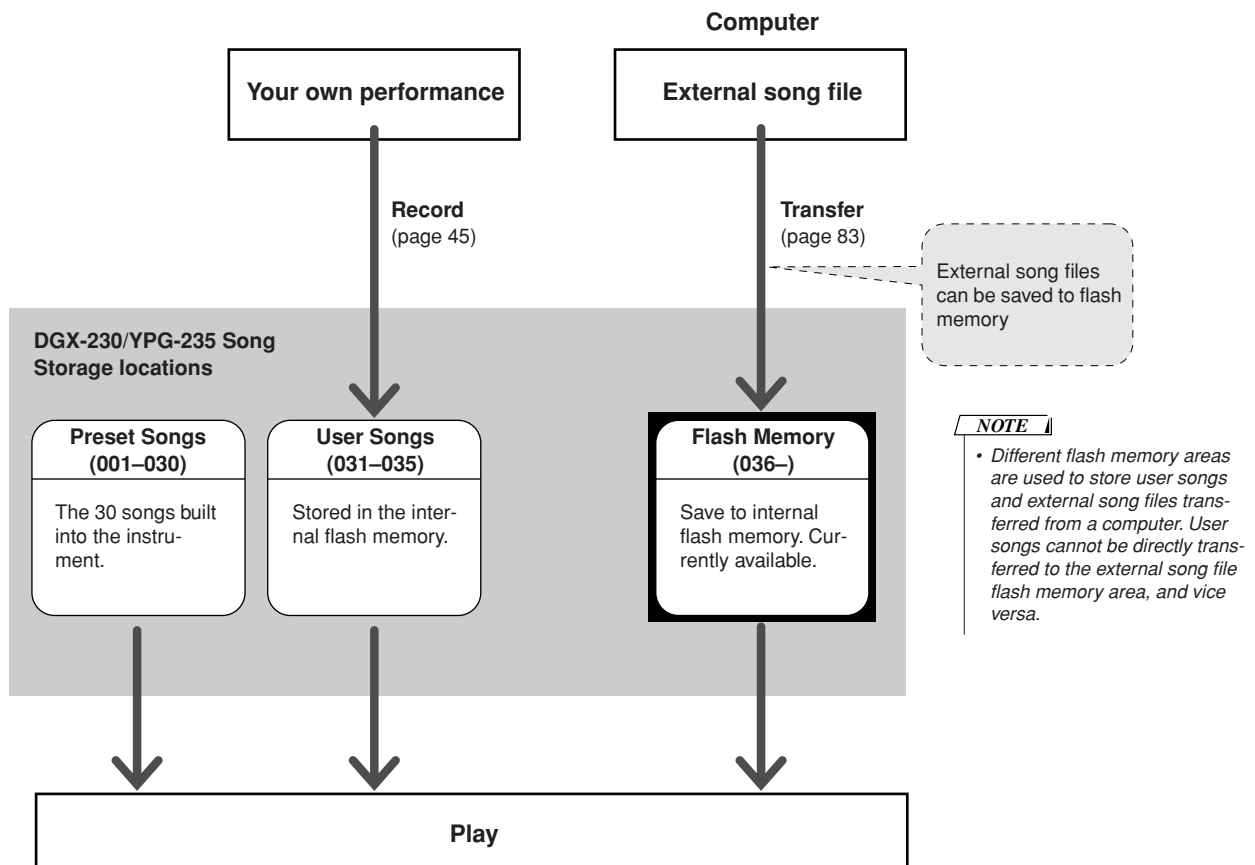



The Easy Way to Play Piano

This instrument includes a performance assistant technology feature that lets you play along with a song and sound like a great pianist (even though you might be making lots of mistakes)! In fact, you can play any notes and still sound good! So even if you can't play piano and can't read a note of music, you can have some musical fun.

Performance assistant technology offers two selectable types. Select the type that produces the best results for you.

- **Chord** No matter where or what you play, the result will be musical, well-balanced sound. This type offers the greatest freedom, allowing you to play anything with both your left and right hands.

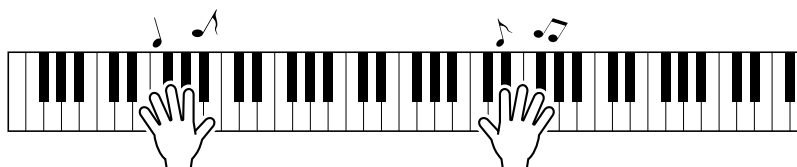

- **Chord/Free (CHD/FREE)**

- If you can play simple right-hand melodies but have trouble with left-hand chords, this is the type for you. The Chord type applies to only the left-hand section of the keyboard, allowing you to easily play chords to support the melody you are playing with your right hand.

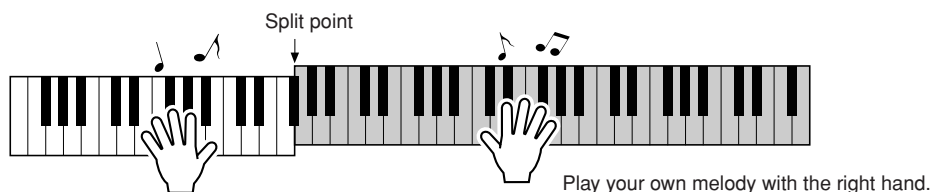

Refer to page 34 for more information on using performance assistant technology to help you play.

CHORD Type—Play with Both Hands

1 Press the [P.A.T. ON/OFF] button.

This turns on the performance assistant technology feature. The P.A.T. icon will appear when the performance assistant technology feature is on.

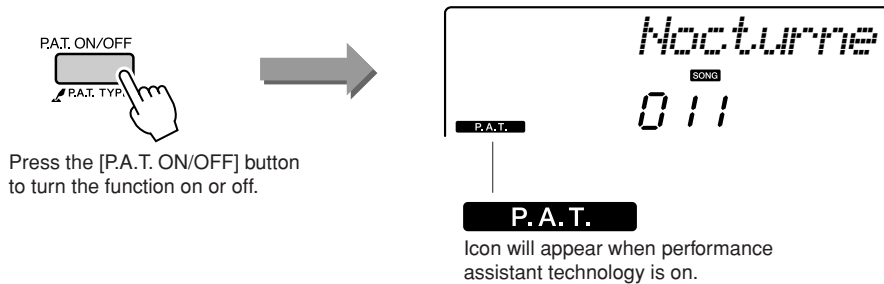

2 Select the CHORD type.

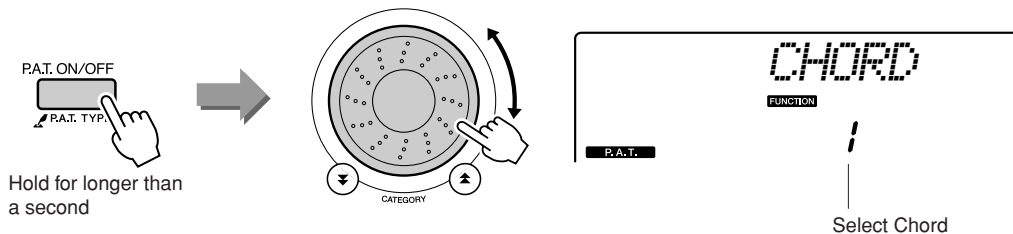

Press and hold the [P.A.T. ON/OFF] button for longer than a second. “PAT Type” appears in the display for a few seconds, then the currently selected performance assistant technology type will be displayed. Select the Chord type by using the dial.

3 Select a song.

Press the [SONG] button, and the Song Select display appears. Select a song by using the dial. For this example try selecting the “010 Ave Maria”.

NOTE
• Using Songs (page 25)

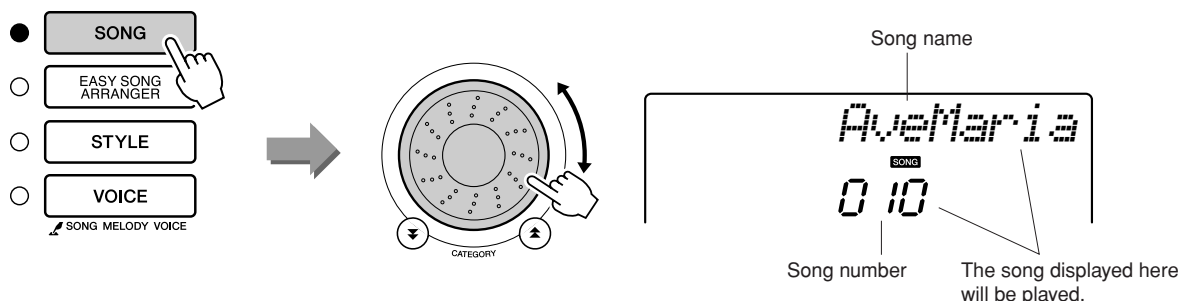

● What is a Song?

You know the normal meaning of this word, but in this instrument the term “Song” refers to the data that makes up a complete song. The performance assistant technology features uses the chord and melody data, and should always be used with a song (page 25).

4 Press the [START/STOP] button.

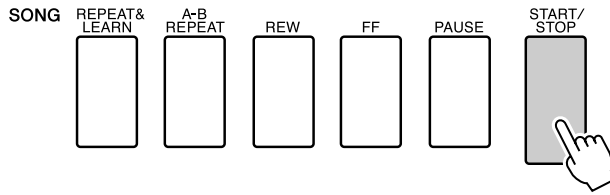

Song playback will begin.

The basic pattern will play repeatedly. Listen to the basic pattern for four measures while getting a feel for the basic pattern, then begin playing yourself from the fifth measure.

5 Play on the keyboard.

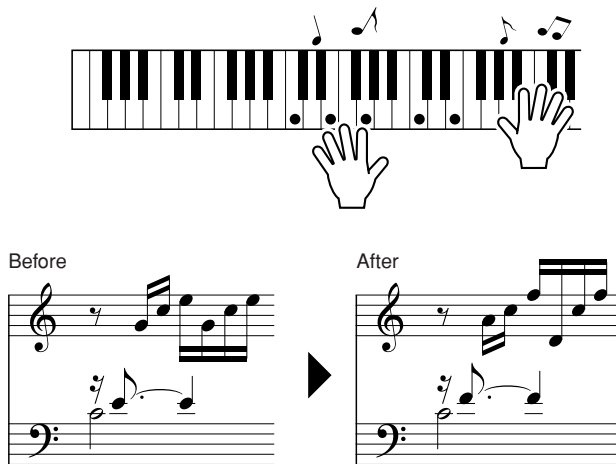

Try playing the score on the left with both hands. You can even play the same keys over and over: C, E, G, C, E, G, C, E. You'll notice that at measure five the notes will come out according to the score on the right. Keep playing, and performance assistant technology Chord type will continue to "correct" the notes that you play. This is the performance assistant technology Chord type.

You can stop song playback at any time by pressing the [START/STOP] button.

6 Press the [P.A.T. ON/OFF] button to turn the performance assistant technology feature off.

NOTE

- The score for *Ave Maria* is provided on page 96.

CHD/FREE Type—Applying the Chord Type to the Left Hand Only

1 Press the [P.A.T. ON/OFF] button.

This turns on the performance assistant technology feature. The P.A.T. icon will appear when the performance assistant technology feature is on.

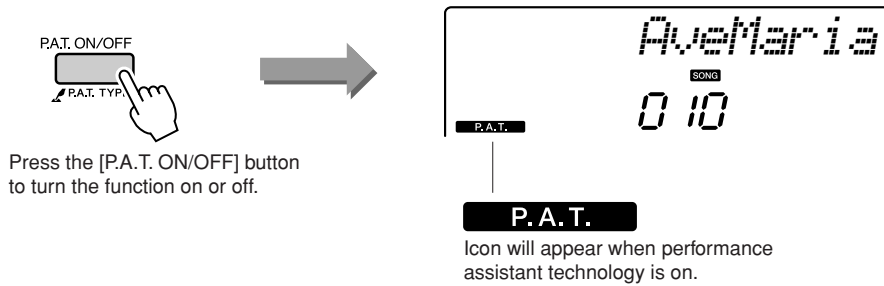

2 Select the CHD/FREE type.

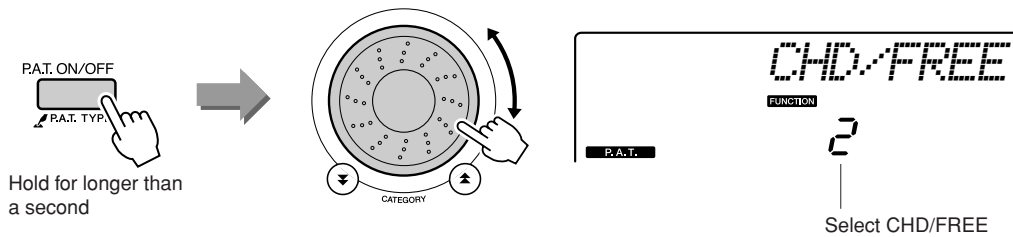

Press and hold the [P.A.T. ON/OFF] button for longer than a second. “PAT Type” appears in the display for a few seconds, then the currently selected performance assistant technology type will be displayed. Select the CHD/FREE type by using the dial.

3 Select a song.

Press the [SONG] button, and the Song Select display appears. Select a song by using the dial. For this example try selecting the “011 Nocturne”.

NOTE
• Using Songs (page 25)

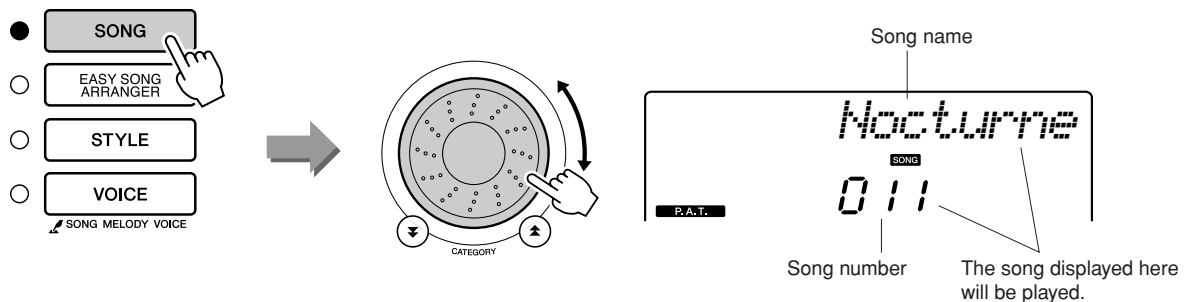

4 Press the [START/STOP] button.

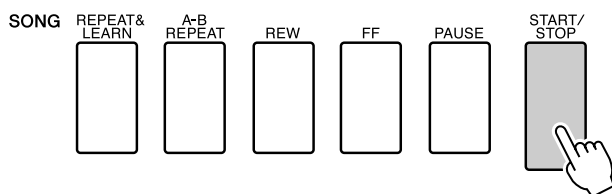

Song playback will begin.

5 Play on the keyboard.

Play to the right of the split point with your right hand, and to the left of the split point with your left hand.

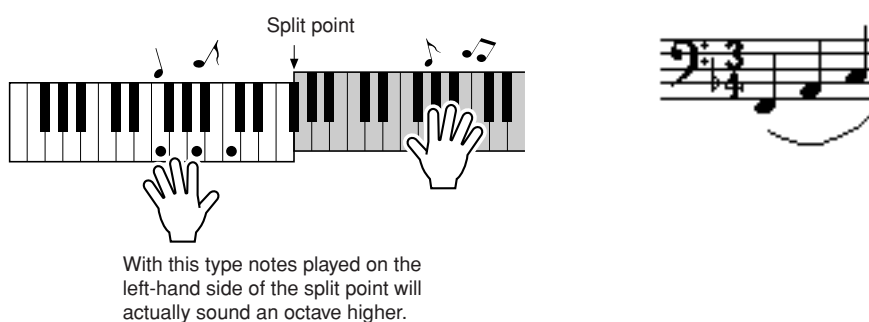

Play the Nocturne melody with your right hand. Continually play an F-A-C arpeggio shown in the illustration with your left hand. Although you're repeatedly playing the same notes with your left hand, the actual notes produced will change to match the music.

This is the performance assistant technology CHD/FREE type.

You can stop song playback at any time by pressing the [START/STOP] button.

6 Press the [P.A.T. ON/OFF] button to turn the performance assistant technology feature off.

NOTE

- The score for Nocturne is provided on page 98.

Use the Performance Assistant to Play Like a Pro!

Here are a few hints for using the Chord type.

If you select Chord/Free, the left-hand section of the keyboard becomes the Chord type section, so use these hints on the lefthand section of the keyboard.

To begin, try to feel the rhythm of the song. Then, with your hands spread as shown in the illustration, simply play the keyboard alternately with your left and right hands (any notes will do).

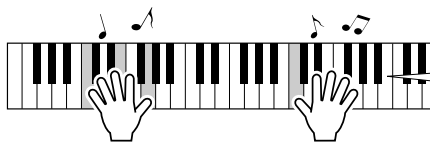

Sounds like you're playing the right notes!

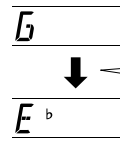

You will get even better results if you match your left-hand rhythm to rhythm of the chord indicator in the display.

How does it sound? You'll get acceptable results no matter where you play thanks to the performance assistant technology Chord type!

Next try the three playing methods illustrated below. Different ways of playing produce different results.

- Play with the left and right hands at the same timing—type 1.

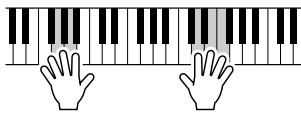

Play 3 notes at once with your right hand.

- Play with the left and right hands at the same timing—type 2.

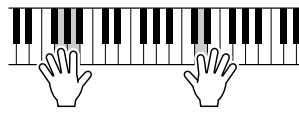

Play 1 note at a time with your right hand (for example: index finger → middle finger → ring finger).

- Play alternately with the left and right hands—type 3.

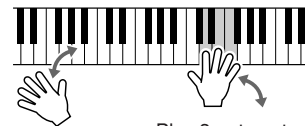

Play 3 notes at once with your right hand.

Once you get a feel for it, try playing chords with your left hand and a melody with your right ... or any other combination.

To use the performance assistant technology feature it is necessary to play a song that includes chord data, or a style with auto accompaniment on.

If a song includes the required data, the chords are shown on the right side of the display (page 52).

Change the Song Tempo

When using the performance assistant technology or in other situations in which the tempo of the song is too fast or too slow for you, you can change the tempo as required. Press the [TEMPO/TAP] button. The tempo display will appear and you can use the dial, the [+] and [-] buttons, or the [0] to [9] number buttons to set to tempo to anywhere from 011 and 280 quarter-note beats per minute.

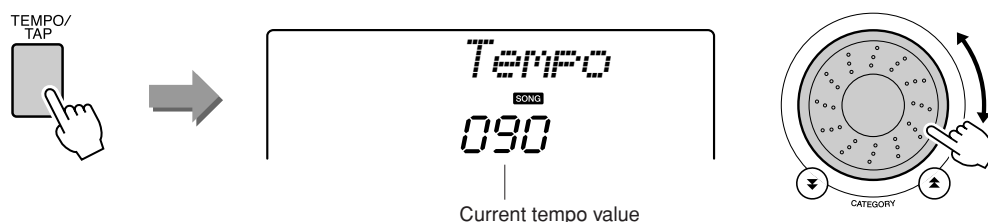

You can return to the original tempo by simultaneously pressing the [+] and [-] buttons.

● About the Beat Display

The arrow marks in the beat display flash in time with the rhythm of the song or style.

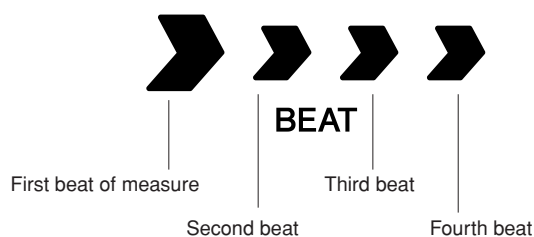



Select a Song For a Lesson

Yamaha Education Suite

You can select song you like and use it for a left-hand, right-hand, or both-hands lesson. You can also use songs (only SMF format 0) downloaded from the Internet and saved to flash memory. (pages 82–84) During the lesson you can play as slowly as you like, and you can even play wrong notes. Song playback will slow down to a speed you can handle. It's never too late to start learning!

Lesson Flow:

Select a song from the Piano Solo, Piano Ensemble category!

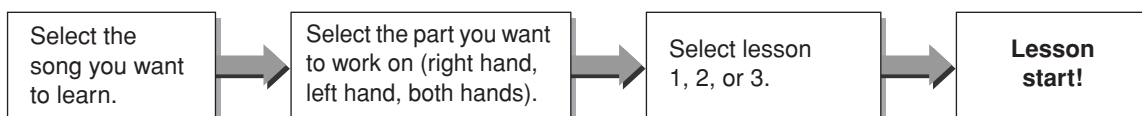

The practice methods:

- **Lesson 1** Learn to play the correct notes.
- **Lesson 2** Learn to play the correct notes with the correct timing.
- **Lesson 3** Learn to play the correct notes at the correct timing along with the song.

Lesson 1—Waiting

In this lesson, try playing the correct notes. Play the note shown in the display. The song will wait until you play the right note.

1 Select a song for your lesson.

Press the [SONG] button, and rotate the dial to select the song you want to use for your lesson. As listed on page 28 there are a variety of song types. For this example try selecting the “012 ForElise”.

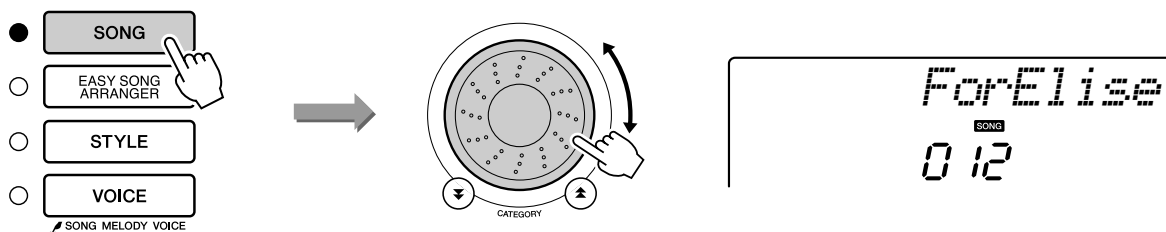

2 Select the part you want to practice.

Press the [R] button for a right-hand lesson, [L] button for a left-hand lesson, or press both the [R] and [L] buttons simultaneously for a both-hands lesson.

The currently selected part is shown in the display.

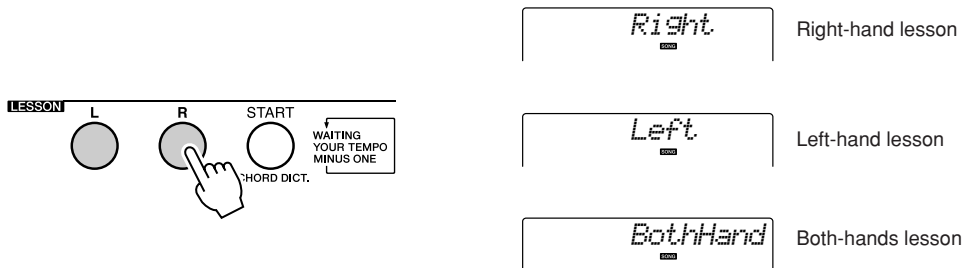

3 Start Lesson 1.

Press the LESSON [START] button to select Lesson 1. Each time the LESSON [START] button is pressed the lesson modes are selected in sequence: Lesson 1 → Lesson 2 → Lesson 3 → Off → Lesson 1 The currently selected mode is shown in the display.

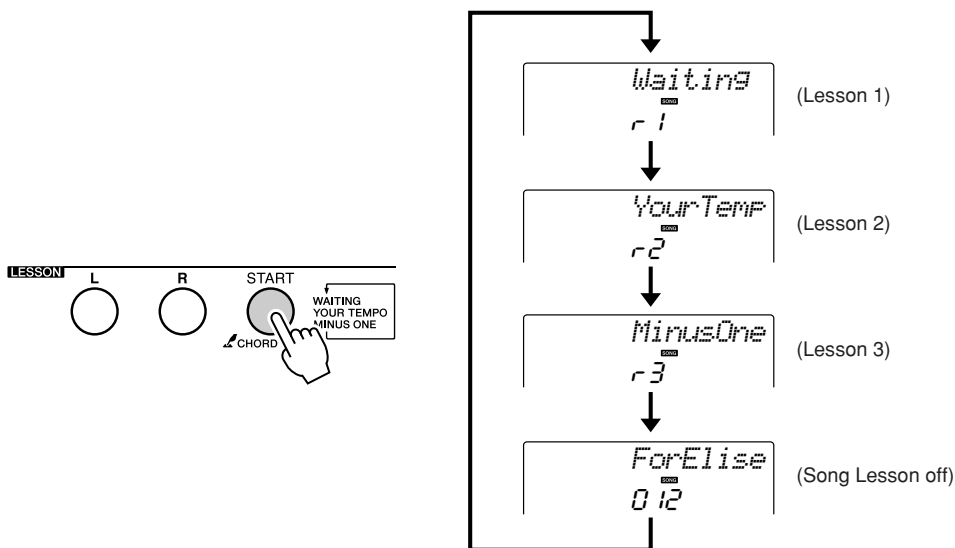

Song playback will begin automatically when you select Lesson 1.



Start the lesson!

Play the note shown in the display. When you play the correct note, the next note you need play is shown. The song will wait until you play the correct note.

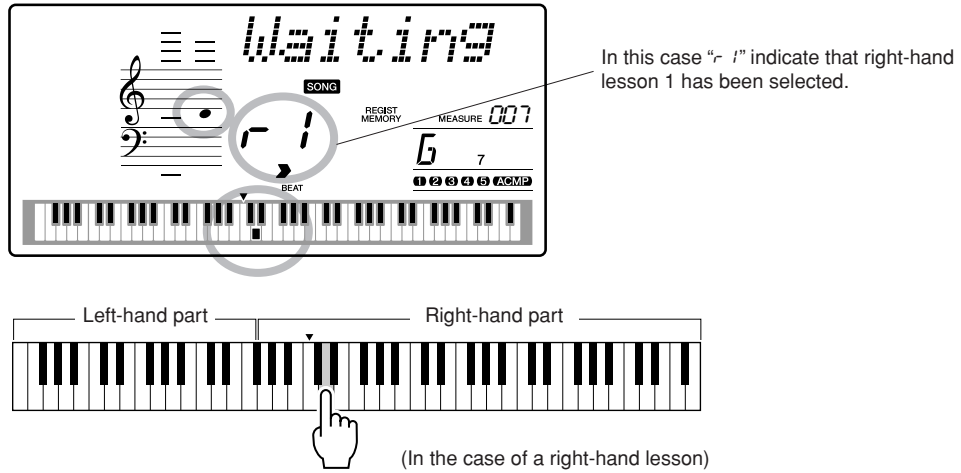



4 Stop the Lesson mode.

You can stop the Lesson mode at any time by pressing the [START/STOP] button.

Once you've mastered Lesson 1, move on to Lesson 2.

■ See How You've Done

- Excellent 
- Very Good 
- Good 
- OK 

When the lesson song has played all the way through your performance will be evaluated in 4 levels: OK, Good, Very Good, or Excellent. "Excellent!" is the highest evaluation.

After the evaluation display has appeared, the lesson will start again from the beginning.

NOTE

- The evaluation feature can be turned off via the FUNCTION Grade item (page 77).

Lesson 2—Your Tempo

Learn to play the correct notes with the correct timing. Song playback tempo will vary to match the speed you are playing at. The song will slow down when you play wrong notes, so you can learn at your own pace.

1 Select the song and part you want to practice (steps 1 and 2 on pages 36, 37).

2 Start Lesson 2.

Each time the LESSON [START] button is pressed the lesson modes are selected in sequence: Lesson 1 → Lesson 2 → Lesson 3 → Off → Lesson 1 ...

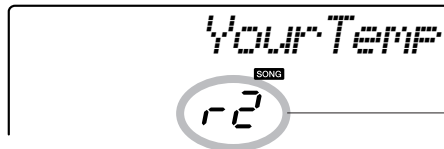
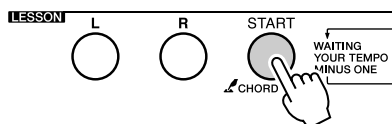

In this case "r 2" indicate that right-hand lesson 2 has been selected.

Song playback will begin automatically when Lesson 2 is selected.



Start the lesson!

Play the note shown in the display. Try to play the notes at the correct timing. As you learn to play the right notes at the right timing the tempo will increase until eventually you'll be playing at the song's original tempo.

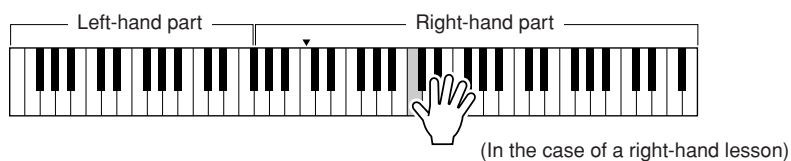

3 Stop the Lesson mode.

You can stop the Lesson mode at any time by pressing the [START/STOP] button.

Once you've mastered Lesson 2, move on to Lesson 3.

Lesson 3—Minus One

Here's where you can perfect your technique.

The song will play at the normal tempo, minus the part you have chosen to play. Play along while listening to the song.

1 Select the song and part you want to practice (steps 1 and 2 on pages 36, 37).

2 Start Lesson 3.

Each time the LESSON [START] button is pressed the lesson modes are selected in sequence: Lesson 1 → Lesson 2 → Lesson 3 → Off → Lesson 1 ...

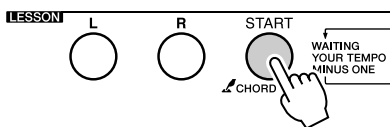

In this case "r 3" indicate that right-hand lesson 3 has been selected.

Song playback will begin automatically when Lesson 3 is selected.



Start the lesson!

Play the note shown in the display.

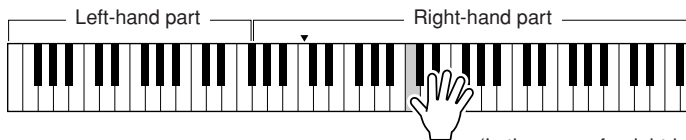

(In the case of a right-hand lesson)

3 Stop the Lesson mode.

You can stop the Lesson mode at any time by pressing the [START/STOP] button.

Practice Makes Perfect—Repeat and Learn

Use this feature when you want to start again just ahead of a section on which you made a mistake, or to repeatedly practice a section you find difficult.

Press the [REPEAT & LEARN] button during a lesson.

The song location will move back four measures from the point at which you pressed the button, and playback will begin after a one-measure count-in. Playback will continue up to the point at which you pressed the [REPEAT & LEARN] button, and then jump back four measures and begin again after a count-in. This process will repeat, so all you have to do is press the [REPEAT & LEARN] button when you make a mistake in order to repeat practice of that section until you get it right.

NOTE

- You can change the number of measures the Repeat and learn function jumps back by pressing a number button [1]–[9] during repeat playback.

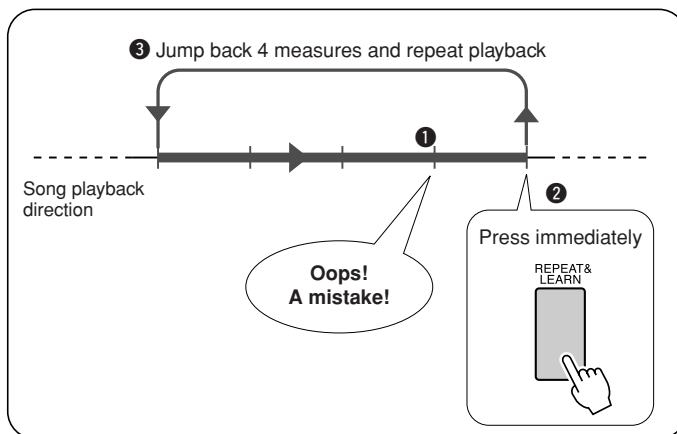
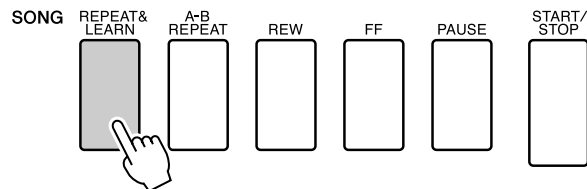



Play Using the Music Database

You want to play music in your favorite style, but you're not sure how to select the best voice and style for the type of music you want to play ... simply select the appropriate style from the Music Database. The panel settings will automatically be adjusted for the ideal combination of sounds and style!

1 Press the [MUSIC DATABASE] button.

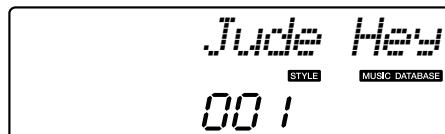
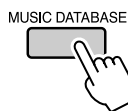

A Music Database list will appear in the display.

2 Select a Music Database.

Referring to the list on the panel or Music Database List on page 107 of the manual, use the dial to select a music database. Select one that matches the image of the song you intend to play.

For this example select the "158 Patrol".

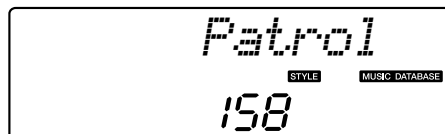
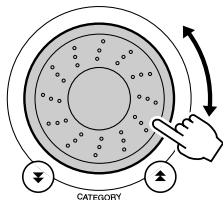

NOTE

- Music Database (MDB) files transferred from a computer can be selected and used in the same way as the internal Music Databases (MDB numbers 301–). File transfer instructions are provided on page 82.

3 Play the chords with your left hand and melody with your right.

The jazz style will start playing when you play a left-hand chord to the left of the split point (page 16). Refer to page 24 for information about playing chords.

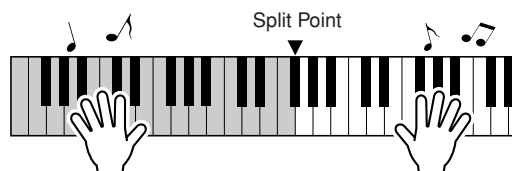

Press the [START/STOP] button to stop playback.



Change a Song's Style

In addition to each song's default style, you can select any other style to play the song with the Easy Song Arranger feature. This means that you can play a song that is normally a ballad, for example, as a bossa nova, as a hip-hop tune, etc. You can create totally different arrangements by changing the style with which a song is played. You can also change the song's melody voice and the keyboard voice for a complete change of image.

Listen to the DEMO Song for Easy Song Arranger

The "Hallelujah Chorus" in the preset songs lets you experience the Easy Song Arranger. Playing it.

Press the [SONG] button, then select a "009 Hallelujah Chorus" by using the dial. Press the [START/STOP] button to play it.

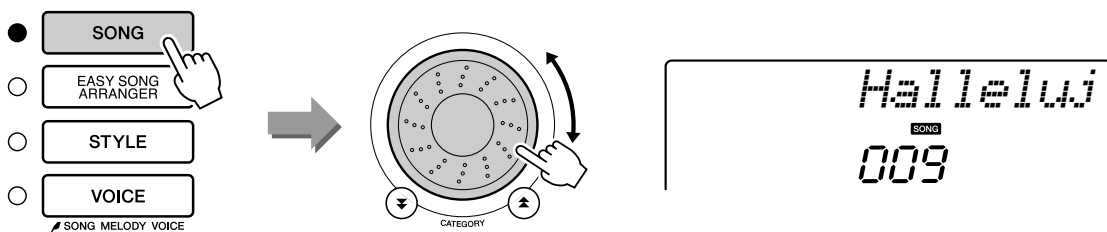

As the song progresses, you will see only the style changes while the song remains the same. Keep in mind that you can enjoy using Easy Song Arranger with other songs as well—any songs that include chord data.

NOTE

- The score for Hallelujah Chorus is provided on page 94.

Using the Easy Song Arranger

1 Press the [EASY SONG ARRANGER] button.

The song number and name will be displayed. You can use the dial to select a different song.



2 Select a Song.

Use the dial to select the song you want to arrange.

3 Listen to the song.

Press the [START/STOP] button to begin playback of the song. Move on to the next step while the song is playing.

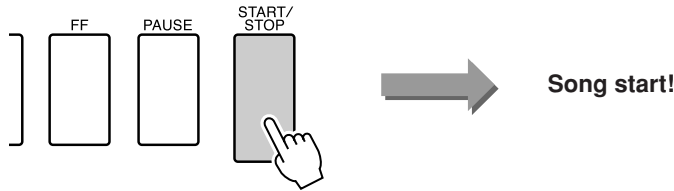

NOTE

• When playing song numbers 010, 011 and 020 to 030 while using the Easy Song Arranger, melody tracks will be automatically muted and no melody will sound. In order to hear the melody tracks you will need to press the SONG MEMORY buttons [3] to [5].

4 Press the [EASY SONG ARRANGER] button.

The style number and name will be displayed. You can use the dial to select a different style.

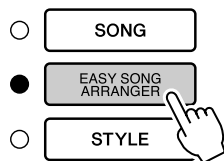

The currently selected style number and name are displayed here.

5 Select a style.

Rotate the dial and listen to how the song sounds with different styles. As you select different styles the song will remain the same while only the styles change. When you have selected a suitable style move on to the next step while the song is still playing (if you have stopped the song, start it again by pressing the [START/STOP] button).

NOTE

• Because the Easy Song Arranger uses song data you can't specify chords by playing in the accompaniment range of the keyboard. The [ACMP ON/OFF] button will not function.
• If the time signature of the song and style are different, the time signature of the song will be used.

6 Select a voice you want to play as a song melody.

Press the [VOICE] button. The currently selected voice number and name will be displayed. Use the dial to select a different voice.

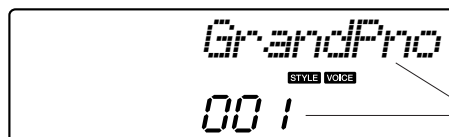
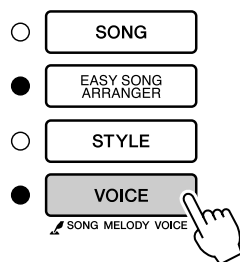

The currently selected voice number and name are displayed here.

7 Change the song's melody voice.

Press and hold the [VOICE] button for longer than a second. After SONG MELODY VOICE appears on the display the voice you selected in step 6 becomes the song's melody voice.

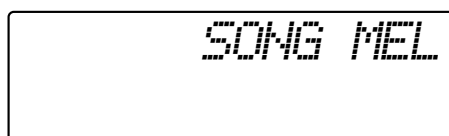
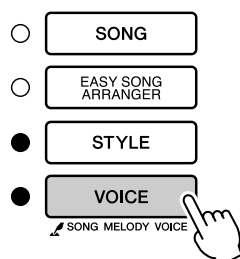

Hold for longer than a second



Record Your Own Performance

You can record up to 5 of your own performances and save them as user songs 031 through 035. The recorded song can be played back on the instrument.

Recordable Data

You can record to a total of 6 tracks: 5 melody tracks and 1 style (chord) track. Each track can be recorded individually.

- **Melody Track [1]–[5]**..... Record the melody parts.
- **Style Track [A]** Records the chord part.

NOTE

• Up to approximately 10,000 notes can be recorded for the five user songs if you record only to the melody tracks. Up to approximately 5,500 chord changes can be recorded for the five songs if you record only to the style track.

Track Configuration

To record your own performance, first use the SONG MEMORY [1]–[5] and [A] buttons to specify the track(s) you want to record on. The track you record on determines the part that plays back later.

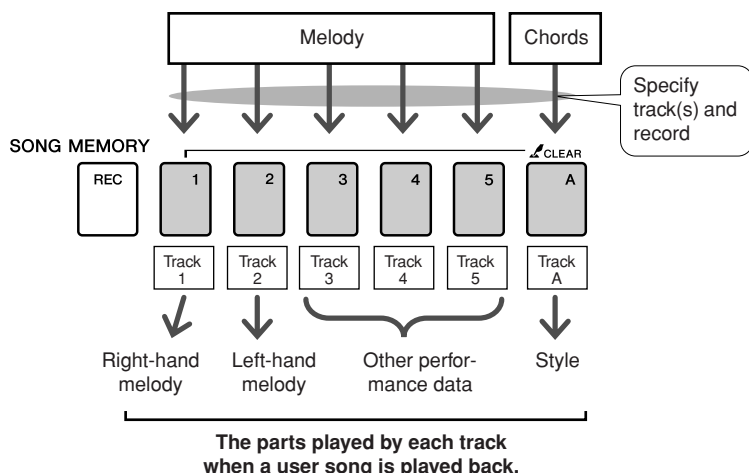

- **Track [1]**—Will play back as the right-hand melody part (MELODY R)
- **Track [2]**—Will play back as the left-hand melody part (MELODY L)
- **Tracks [3]–[5]**—Will play back as “other” performance data.
- **Track [A]**—Will play back as the Style (auto-accompaniment) part.

NOTE

• **The Difference Between MELODY R and MELODY L ...** Songs are a combination of a melody and an auto-accompaniment style. Normally “melody” refers to the right-hand part, but in this instrument “melody” parts are provided for both the right and left hands. MELODY R is the melody part played by the right hand, and MELODY L is the melody part played by the left hand.

Recording Procedure

1 Press the [SONG] button, then use the dial to select the user song number (031–035) you want to record to.

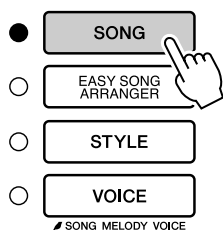

Rotate the dial to select a song number between 031 and 035.

2 Select the track(s) you want to record to and confirm your selection on the display.

◆ Record a Melody Track and the Accompaniment Track Together

Press the melody track button [1]–[5] you want to record to while holding the [REC] button.

Next, press the [A] button while holding the [REC] button.

The selected tracks will flash in the display.

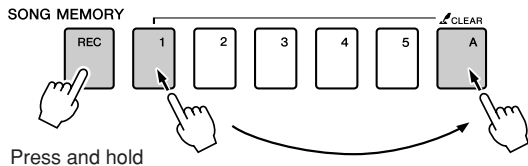

⚠ CAUTION

- If you record to a track that contains previously-recorded data the previous data will be overwritten and lost.

NOTE

- Style accompaniment is automatically turned on when you select the style track [A] for recording.
- Style accompaniment cannot be turned on or off while recording is in progress.
- If you use a split voice for recording, notes played to the left of the split point will not be recorded.

◆ Record a Melody track

Press the melody track button [1]–[5] you want to record to while holding the [REC] button.

The selected track will flash in the display.

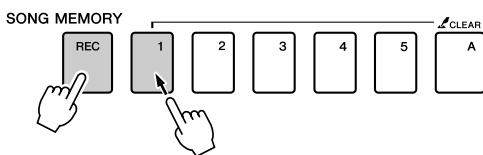

NOTE

- If style accompaniment is on and track [A] has not yet been recorded, the style track [A] will automatically be selected for recording when a melody track is selected. If you only want to record a melody track, be sure to turn the style track [A] off.

To cancel recording to a selected track, press that track button a second time. Style accompaniment cannot be turned on or off while recording is in progress.

3 Recording will start when you play on the keyboard.

You can also start recording by pressing the [START/STOP] button. The current measure will be shown on the display during recording.

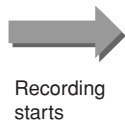
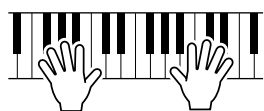

Current measure

NOTE

- If the memory becomes full during recording a warning message will appear and recording will stop automatically. Use the song clear or track clear (page 48) function to delete unwanted data and make more room available for recording, then do the recording again.

4 Stop recording by pressing the [START/STOP] or [REC] button.

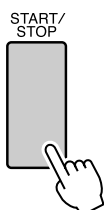

or

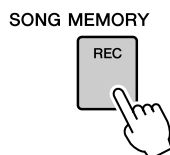

If you press the [INTRO/ENDING/rit.] button while recording the style track an appropriate ending pattern will play and then recording will stop. When recording stops the current measure number will return to 001 and the recorded track numbers in the display will light.

● **To Record Other Tracks**

Repeat steps 2 through 4 to record any of the remaining tracks.

By selecting an unrecorded track—SONG MEMORY buttons [1]–[5], [A]—you can record the new track while listening to previously recorded tracks (the playback tracks will appear in the display). You can also mute previously recorded tracks (the muted tracks will not appear in the display) while recording new tracks.

● **To Re-record a Track**

Simple select the track you want to re-record for recording in the normal way.

The new material will overwrite the previous data.

5 When the recording is done ...

◆ **To Play Back a User Song**

User songs are played back in the same way as regular songs (page 25).

- 1 Press the [SONG] button.
- 2 The current song number/name will be displayed—use the dial to select the user song (031–035) you want to play.
- 3 Press the [START/STOP] button to start playback.

● **Data Recording Limitations**

- The split voice cannot be recorded.
- The following data are recorded at the beginning of the track. Changes made during the song will not be recorded.
 - reverb type, chorus type, time signature, style number, style volume, tempo (When the style track is recorded)

Song Clear—Deleting User Songs

This function clears an entire user song (all tracks).

NOTE

• If you only want to clear a specific track from a user song use the Track Clear function.

1 Press the [SONG] button, then select the user song (031–035) you want to clear.

2 Press and hold the SONG MEMORY [1] button for longer than a second while holding the SONG MEMORY [A] button.

A confirmation message will appear on the display.

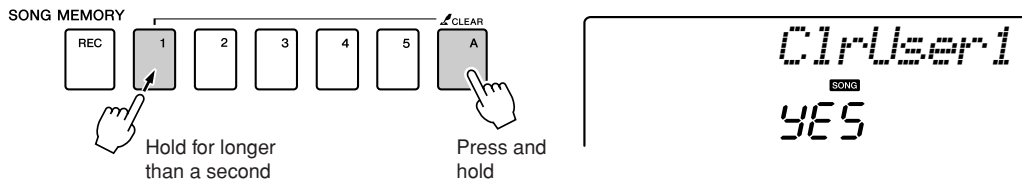

3 Press the [+] button.

A confirmation message will appear on the display. You can cancel the clear operation by pressing the [-] button.

NOTE

• To execute the Song Clear function press the [+] button. Press [-] to cancel the Song Clear operation.

4 Press the [+] button to clear the song.

The clear-in-progress message will appear briefly on the display while the song is being cleared.

Track Clear—Deleting a Specified Track from a User Song

This function lets you delete a specified track from a user song.

1 Press the [SONG] button, then select the user song (031–035) you want to clear.

2 Press and hold the SONG MEMORY track button ([1]–[5], [A]) corresponding to the track you want to clear for longer than a second.

A confirmation message will appear on the display.

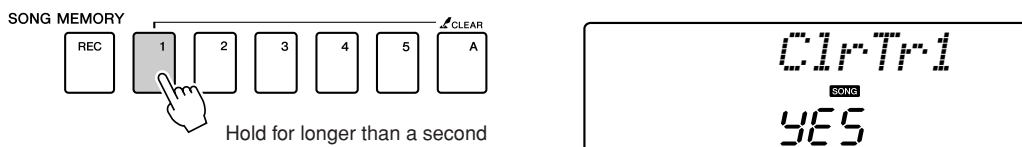

3 Press the [+] button.

A confirmation message will appear on the display. You can cancel the clear operation by pressing the [-] button.

NOTE

• To execute the Track Clear function press the [+] button. Press [-] to cancel the Track Clear operation.

4 Press the [+] button to clear the track.

The clear-in-progress message will appear briefly on the display while the track is being cleared.



Backup and Initialization

Backup

The following settings are always backed up, and are maintained even when the power is turned off. If you want to initialize the settings, use the Initialize operation as explained below.

● The Backup Parameters

- User Songs
- Style 161
- Registration Memory
- FUNCTION Settings: Tuning, Split Point, Touch Sensitivity, Style Volume, Song Volume, Metronome Volume, Grade, Demo Cancel, Master EQ type

Initialization

This function erases all backup data in the instrument's flash memory and restores the initial default settings. The following initialization procedures are provided.

■ Backup Clear

To clear data backed up to the internal flash memory—panel user setting, registration memory, user songs, style file 161—turn the power on by pressing the [STANDBY/ON] switch while holding the highest white key on the keyboard. The backed up data will be erased and the default values restored.

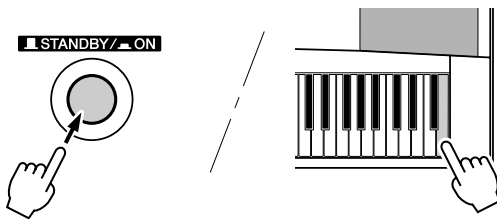

■ Flash Clear

To clear song, style and music database that have been transferred to the internal flash memory from a computer, turn the power on by pressing the [STANDBY/ON] switch while simultaneously holding the highest white key on the keyboard and the three highest black keys.

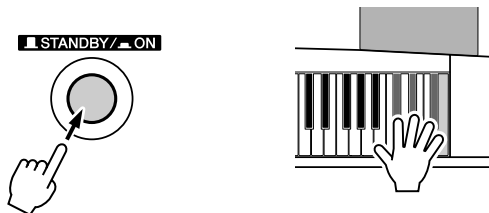

⚠ CAUTION

- When you execute the Flash Clear operation, data you have purchased will also be cleared. Be sure to save data you want to keep to a computer.



Basic Operation and Displays

Basic Operation

Overall DGX-230/YPG-235 control is based on the following simple operations.

- 1** Press a button to select a basic function.
- 2** Use the dial to select an item or value.
- 3** Start a function.

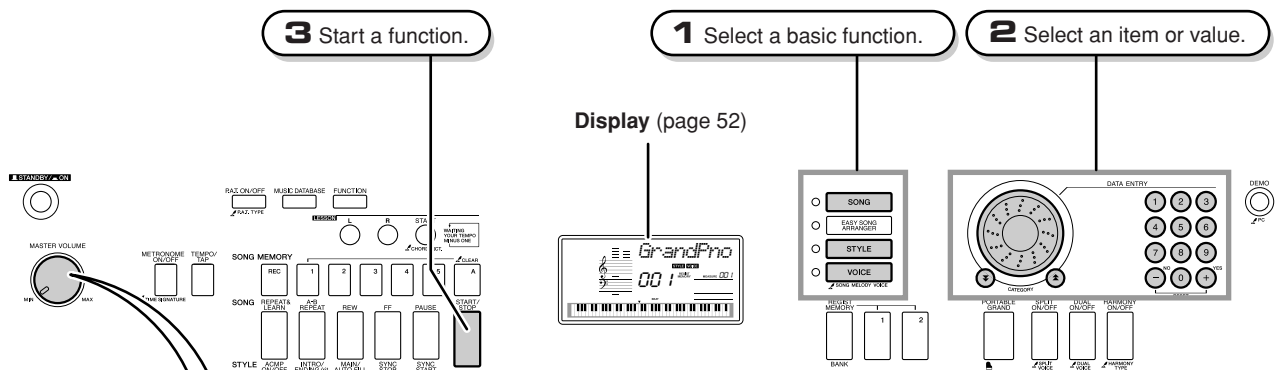

Display (page 52)



● Volume Adjustment

Adjusts the volume of the sound heard via the instrument's speakers or a pair of headphones plugged into the PHONES jack.

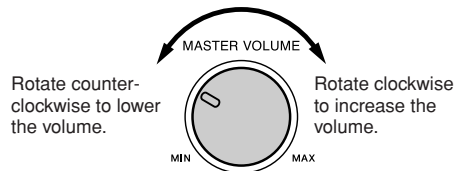

The "Press & Hold" Symbol

The "  " symbol that appears next to some buttons indicates that the button can be pressed and held for longer than a second to call up a related function. This provides convenient direct access to a range of functions.

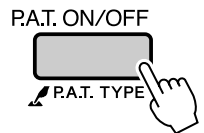

1 Press a button to select a basic function.

- SONG** — Select a song you want to listen to or a song you want to use for a lesson.
- EASY SONG ARRANGER**
- STYLE** — Select an auto-accompaniment style.
- VOICE** — Select a voice you want to play on the keyboard.
SONG MELODY VOICE

2 Use the dial to select an item or value.

When you select a basic function, the item corresponding to that function will be displayed. You can then use the dial or the number buttons [0]–[9] to select the desired item.



This portion of the display indicates the name and number of the currently selected song, voice and style. It also displays the name and current setting/value of other functions.

■ Changing Values.....

● Dial

Rotate the dial clockwise to increase the value of the selected item, or counter-clockwise to decrease its value. Rotate the dial continuously to continuously increase or decrease the value.

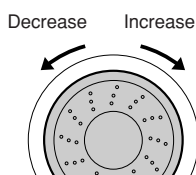

● [+] and [-] Buttons

Press the [+] button briefly to increment the value by 1, or press the [-] button briefly to decrement the value by 1. Press and hold either button to continuously increment or decrement the value in the corresponding direction.

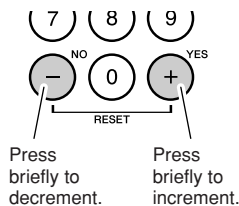

● Number Buttons [0]–[9]

The number buttons can be used to directly enter a song number or parameter value. Hundreds or tens digits that are “0” can be omitted (see below).

Example: Song number “003” can be entered in three ways.

- [0] → [0] → [3]
- [0] → [3]
 (“003” will appear on the display after a brief delay)
- [3]
 (“003” will appear on the display after a brief delay)

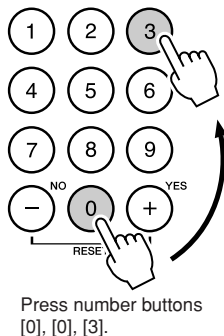

● CATEGORY [▲] and [▼] buttons

When selecting a song, style, or voice, you can use these buttons to jump to the first item in the next or previous category.

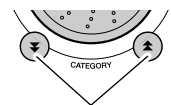

Jump to the first item in the next or previous category.

The CATEGORY [▲] and [▼] buttons are useful for selecting categorized items, as in the example below.

Example: VOICE SELECT

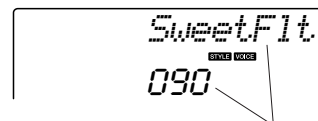

The first voice in the selected category is selected.

In a display in which a category appears, selection is easy if you first use the CATEGORY [▲] and [▼] buttons to select the category containing the desired item, then use the dial or [+] and [-] buttons to select the item. This can be particularly handy when you have to select from a large number of voices.

In most procedures described throughout this owner's manual the dial is recommended for selection simply because it is the easiest and most intuitive selection method. Please note however, that most items or values that can be selected using the dial can also be selected using the [+] and [-] buttons.

3 Start a function.



This is the [START/STOP] button.

Press the [START/STOP] button after pressing the [SONG] or [STYLE] button to start playback of the selected song or style (rhythm).

Display Items

The display shows all of the current basic settings: song, style, voice. It also includes a range of indicators that show the on/off status of a range of functions.

Notation

Displays the melody and chord notes of a song when the Song Lesson function is in use, or the notes of chords you specify when the Dictionary function is in use. At other times the notes you play on the keyboard are displayed.



NOTE

- Any notes occurring below or above the staff are indicated by "8va" in the notation.
- For a few specific chords, not all notes may be shown in the notation section of the display. This is due to space limitations in the display.

BEAT number and MEASURE

Indicates the beat number in a measure during the Metronome function. Indicates the current measure during playback of a song or style. (see pages 56, 46)

MEASURE 00 1

Chord Display

Indicates the name of the chord currently being played back, or the name of the chord being played on the keyboard.

F

Song Track Display

Information related to the song tracks is shown here. (see pages 45, 72)

1 2 3 4 5 ACMP

HARMONY

Indicates that Harmony is turned on. (see page 53)

HARMONY

DUAL

Indicates that the Dual voice is turned on. (see page 15)

DUAL

SPLIT

Indicates that the Split voice is turned on. (see page 16)

SPLIT

Performance assistant technology

Indicates that performance assistant technology is turned on. (see page 30)

P. A. T.

ACMP ON

Indicates that Accompaniment is turned on. (see page 20)

ACMP ON

SYNC STOP

Indicates that SYNC STOP is turned on. (see page 64)

SYNC STOP

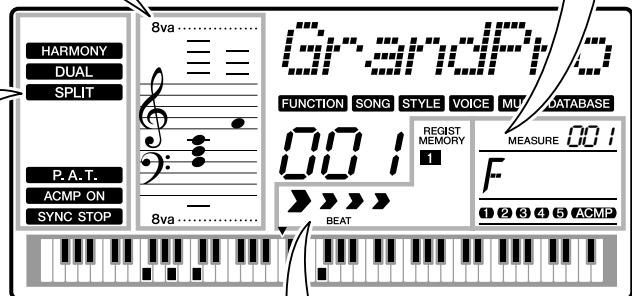

Beat Display

Indicates the current style or song beat with flashing arrows. (see page 35)



Registration Memory

The selected registration memory that contains data is displayed.

REGIST
MEMORY
1

Adding Effects

Harmony

This feature adds harmony notes to the main voice.

1 Press the [HARMONY ON/OFF] button to turn Harmony feature on.

To turn Harmony off, press the [HARMONY ON/OFF] button again.

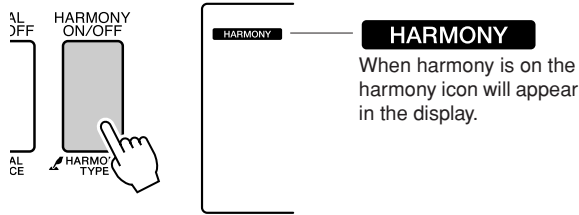

When you press the [HARMONY ON/OFF] button to turn this feature on, the appropriate harmony type for the currently selected main voice is automatically selected.

2 Press and hold the [HARMONY ON/OFF] button for longer than a second so that the Harmony Type item appears.

“HarmType” appears in the display for a few seconds, and the currently selected harmony type will be displayed. Use the dial to select a different harmony type.

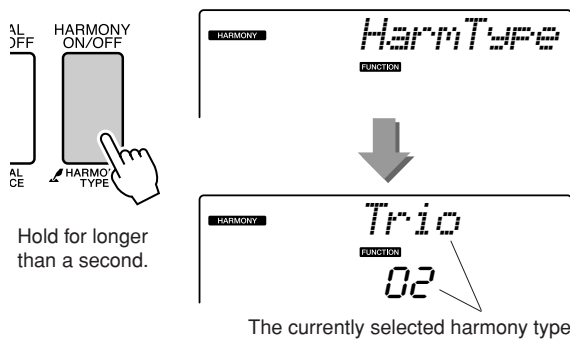

3 Use the dial to select a harmony type.

Refer to the Effect Type List on page 109 for information about the available harmony types. Try playing the keyboard with the harmony function. The effect and operation of each Harmony Type is different—refer to the below section “How to sound each Harmony Type” as well as the Effect Type List for details.

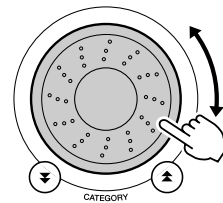

NOTE

- The harmony notes can be added only to the Main Voice, not to Dual or Split Voices.
- The keys left of the Split Point of the keyboard produce no harmony notes when the auto accompaniment is on (ACMP ON is lit).

● How to sound each Harmony Type

- Harmony type 01 to 05



Press the right-hand keys while playing chords in the auto accompaniment range of the keyboard when the Auto Accompaniment is on (page 20).

- Harmony type 06 to 12 (Trill)

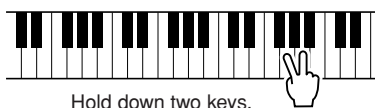

- Harmony type 13 to 19 (Tremolo)

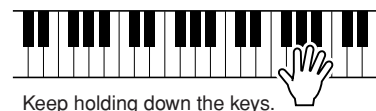

- Harmony type 20 to 26 (Echo)

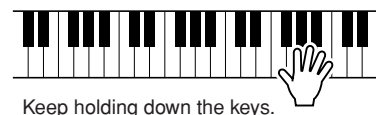

You can adjust the Harmony Volume in the Function Settings (page 62).

Adding Reverb

Reverb lets you play with a rich concert hall type ambience. When you select a style or song the optimum reverb type for the voice used is automatically selected. If you want to select a different reverb type, use the procedure described below.

1 Press the [FUNCTION] button.

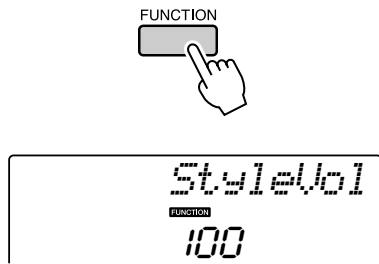

2 Use the CATEGORY [▲] and [▼] buttons to select the Reverb Type item.

“Reverb” appears in the display for a few seconds, and the currently selected reverb type will be displayed.

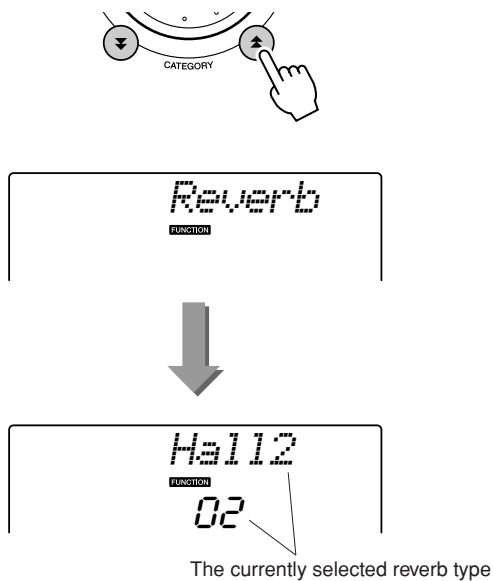

3 Use the dial to select a reverb type.

You can check how the selected reverb type sounds by playing on the keyboard.

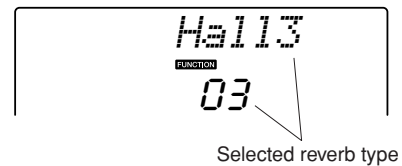
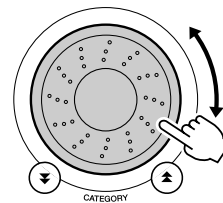

Refer to the Effect Type List on page 109 for information about the available reverb types.

● Adjusting the Reverb Level

You can individually adjust the amount of reverb that is applied to the main, dual, and split voices. (See page 76).

Adding Chorus

The chorus effect creates a thick sound that is similar to many of the same voices being played in unison. When you select a style or song the optimum chorus type for the voice used is automatically selected. If you want to select a different chorus type, use the procedure described below.

1 Press the [FUNCTION] button.

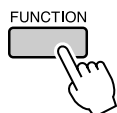

2 Use the CATEGORY [▲] and [▼] buttons to select the Chorus Type item.

“Chorus” appears in the display for a few seconds, and the currently selected chorus type will be displayed.

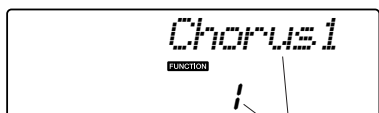
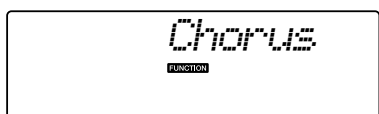
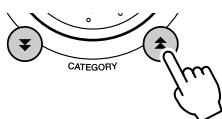

The currently selected chorus type

3 Use the dial to select a chorus type.

You can check how the selected chorus type sounds by playing on the keyboard.

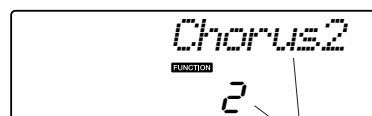
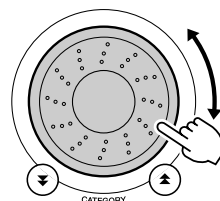

Selected chorus type

Refer to the Effect Type List on page 109 for information about the available chorus types.

● Adjusting the Chorus Level

You can individually adjust the amount of chorus that is applied to the main, dual, and split voices. (See page 76).

Handy Performance Features

The Metronome

The instrument includes a metronome with adjustable tempo and time signature. Use it to set the tempo that is most comfortable for you.

Start the metronome

Turn the metronome on and start it by pressing the [METRONOME ON/OFF] button.

To stop the metronome, press the [METRONOME ON/OFF] button again.

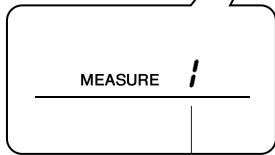
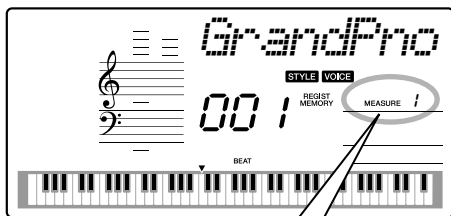

Indicates the beat number in the measure

Adjusting the Metronome Tempo

1 Press the [TEMPO/TAP] button to call up the tempo setting.

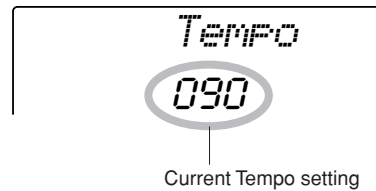
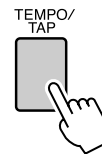

2 Use the dial to select a tempo from 11 to 280.

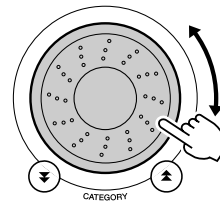

■ Setting the Number of Beats per Measure, and the Length of Each Beat

In this example we'll set up a 5/8 time signature.

- 1 Press and hold the [METRONOME ON/OFF] button for longer than a second to select the number of beats per measure function "TimesigN".

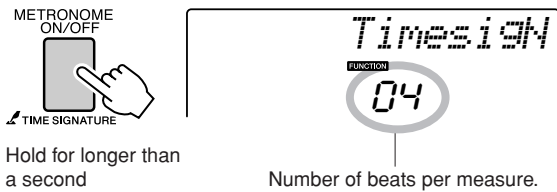

- 2 Use the dial to select the number of beats per measure.

A chime will sound on the first beat of each measure while the other beats will click. All beats will simply click with no chime at the beginning of each measure if you set this parameter to "00".

The available range is from 0 through 60. Select 5 for this example.

NOTE

• The metronome time signature will synchronize to a style or song that is playing, so these parameters cannot be changed while a style or song is playing.

- 3 Press the CATEGORY [▲] and [▼] buttons as many times as necessary to select the beat length function "TimesigD".

The currently selected beat length will be displayed.

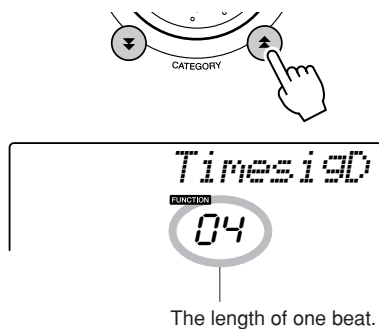

- 4 Use the dial to select the beat length.

Select the required length for each beat: 2, 4, 8, or 16 (half note, quarter note, eighth note, or 16th note). Select 8 for this example.

■ Adjusting the Metronome Volume.....

- 1 Press the [FUNCTION] button.

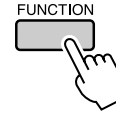

- 2 Use the CATEGORY [▲] and [▼] buttons to select the Metronome Volume item.

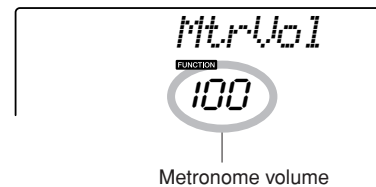
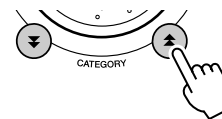

- 3 Use the dial to set the metronome volume as required.

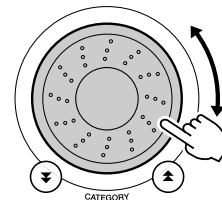

Tap Start

You can start the song/style by simply tapping the [TEMPO/TAP] button at the required tempo—4 times for time signatures in 4, and three times for time signatures in 3. You can change the tempo during song playback by pressing the button just twice.

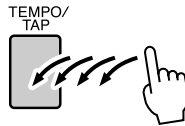

Touch Response Sensitivity

When touch response is on you can adjust the keyboard's sensitivity to dynamics in three steps.

1 Press the [FUNCTION] button.

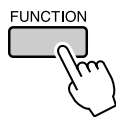

2 Use the CATEGORY [▲] and [▼] buttons to select the Touch Sensitivity item.

“TouchSns” appears in the display for a few seconds, and the currently selected touch sensitivity will be displayed.

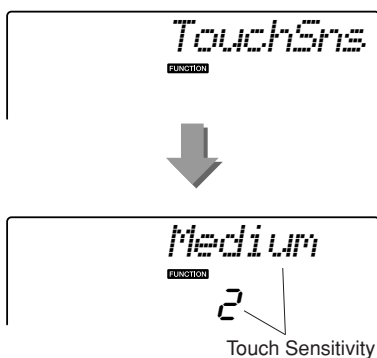
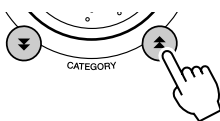

3 Use the dial in response to keyboard dynamics to select a touch sensitivity setting between 1 and 3. Higher values produce greater (easier) volume variation in response to keyboard dynamics—i.e. greater sensitivity.

A setting of “4” results in a fixed touch response, or no level change no matter how hard or how soft you play the keys.

NOTE

- The initial default touch sensitivity setting is “2”.

Panel Sustain

This function adds sustain to the keyboard voices. Use it when you want to add sustain to the voices at all times, regardless of footswitch operation. The sustain function does not affect split voice.

1 Press the [FUNCTION] button.

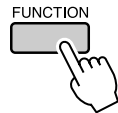

2 Use the CATEGORY [▲] and [▼] buttons to select the Sustain item.

The current setting is displayed.

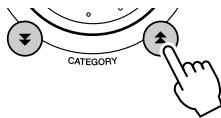

3 You can then use the [+] and [-] buttons to turn panel sustain on or off.

NOTE

- The sustain of some voices may not be markedly affected when the panel sustain function is turned on.

Pitch Bend

The pitch bend wheel can be used to add smooth pitch variations to notes you play on the keyboard. Roll the wheel upward to raise the pitch, or downward to lower the pitch. If you use this feature with a voice such as the “040 Overdriven” guitar voice, you can produce remarkably realistic string-bending effects. You can change the amount of pitch bend produced by the wheel, as described on page 76.

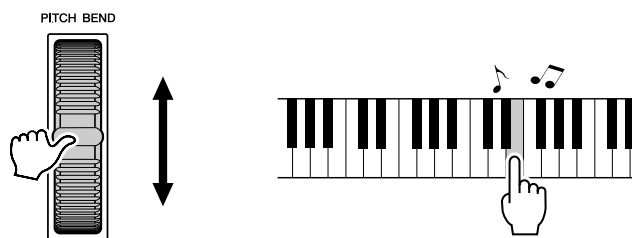

Pitch Controls

◆ Large Pitch Changes (Transpose)

The overall pitch of the instrument can be shifted up or down by a maximum of 1 octave in semitone increments.

1 Press the [FUNCTION] button.

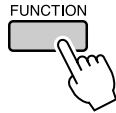

2 Use the CATEGORY [▲] and [▼] buttons to select the Transpose item.



3 Use the dial to set the transpose value between -12 and +12 as required.

NOTE

• The pitch of Drum Kits voices cannot be changed.

◆ Small Pitch Changes (Tuning)

The overall tuning of the instrument can be shifted up or down by a maximum of 100 cents in 1-cent increments (100 cents = 1 semitone).

1 Press the [FUNCTION] button.

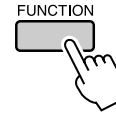

2 Use the CATEGORY [▲] and [▼] buttons to select the Tuning item.



3 Use the dial to set the tuning value between -100 and +100 as required.

NOTE

• The pitch of Drum Kits voices cannot be changed.

One Touch Setting

Sometimes selecting the ideal voice to play with a song or style can be confusing. The One Touch Setting feature automatically selects a well-balanced voice for you when you select a style or song. Simply select voice number “000” to activate this feature.

- 1** Select voice number “000” (steps 1 to 2 on page 14).

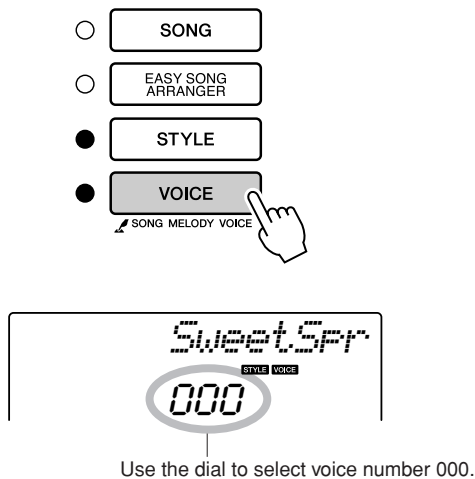

- 2** Select and play back any song (steps 1 to 3 on page 25).

- 3** Play the keyboard and remember the sound of the voice.

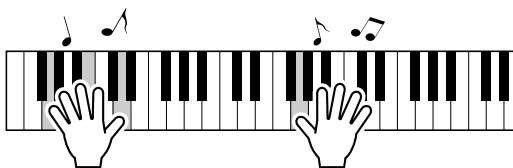

If you have stopped playback at some point during this procedure press the [START/STOP] button to start playback again.

- 4** Use the dial to change songs, then play the keyboard and listen to the voice.

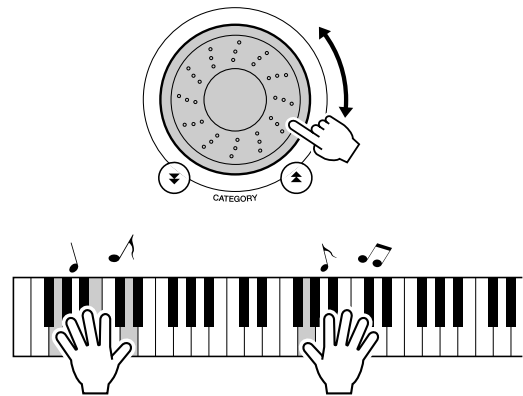

You should hear a different keyboard voice than you played in step 3. Press the [VOICE] button after changing songs to see the name of the voice being used.

Adjusting the Harmony Volume

1 Press the [FUNCTION] button.

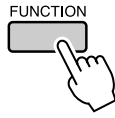

2 Use the CATEGORY [▲] and [▼] buttons to select the Harmony Volume item.

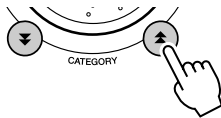

3 Use the dial to set the harmony volume between 000 and 127.

Select an EQ Setting for the Best Sound

Five different master equalizer (EQ) settings are provided to give you the best possible sound when listening through different reproduction systems—the instrument’s internal speakers, headphones, or an external speaker system.

1 Press the [FUNCTION] button.

The currently selected function will appear in the display.

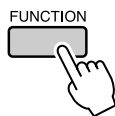

2 Press the CATEGORY [▲] and [▼] buttons as many times as necessary to select the master EQ type function “MasterEQ”.

“MasterEQ” will be shown in the display for a few seconds, then the currently selected EQ type will appear.

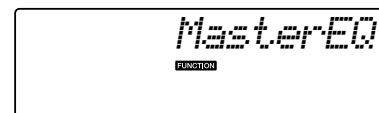
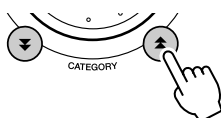

The currently selected master EQ type.

3 Use the dial to select the desired Master EQ setting.

Five settings are available: 1–5. Settings 1 and 2 are best for listening via the instrument’s built-in speakers, setting 3 is for headphones, and settings 4 and 5 are ideal for listening via external speakers.

Style (Auto-accompaniment) Functions

Basic operation of the Style (auto-accompaniment) feature is described on page 19 of the Quick Guide.

Here are some other ways you can play the styles, the style volume adjustment procedure, how you can play chords using the styles, and more.

Pattern Variation (Sections)

The DGX-230/YPG-235 features a wide variety of style “sections” that allow you to vary the arrangement of the accompaniment to match the song you are playing.

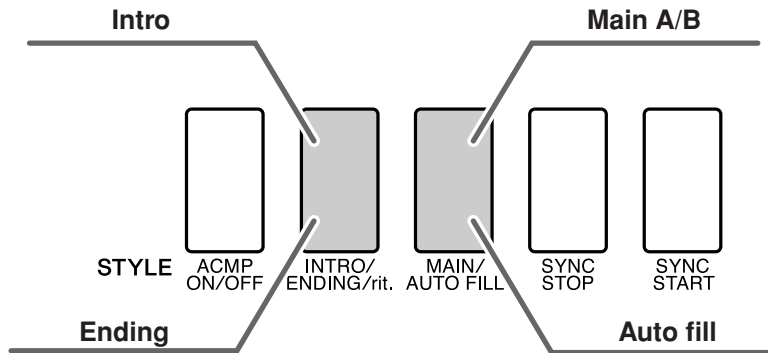

● INTRO section

This is used for the beginning of the Song. When the intro finishes playing, accompaniment shifts to the main section. The length of the intro (in measures) differs depending on the selected Style.

● MAIN section

This is used for playing the main part of the Song. It plays a main accompaniment pattern, and repeats indefinitely until another section’s button is pressed. There are two variations on the basic pattern (A and B), and the Style playback sound changes harmonically based on the chords you play with your left hand.

● Fill-in section

This is automatically added before changing to section A or B.

● ENDING section

This is used for the ending of the Song. When the ending is finished, the auto accompaniment stops automatically. The length of the ending (in measures) differs depending on the selected Style.

1 Press the [STYLE] button and then select a style.

2 Press the [ACMP ON/OFF] button to turn auto accompaniment on.

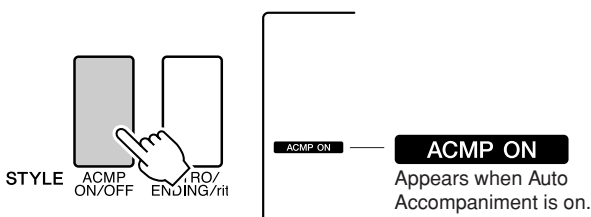

3 Press the [SYNC START] button to turn synchro start on.

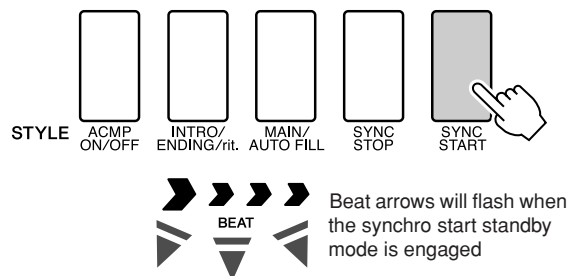

● Synchro Start

When the synchro start standby mode is engaged, style playback will begin as soon as you play a chord in the accompaniment range of the keyboard. You can disengage the synchro-start standby mode by pressing the [SYNC START] button again.

4 Press the [MAIN/AUTO FILL] button.

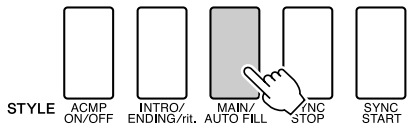

The name of the selected section—MAIN A or MAIN B—will be displayed.

5 Press the [INTRO/ENDING/rit.] button.

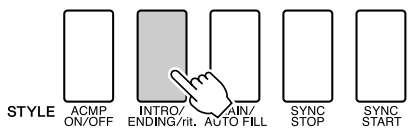

You're now ready to play the intro.

6 As soon as you play a chord with your left hand, the Intro of the selected Style starts.

For this example, play a C major chord (as shown below). For information on how to enter chords, see “Playing Auto-accompaniment Chords” on page 24.

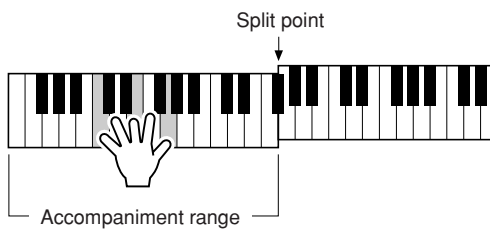

7 Press the [MAIN/AUTO FILL] button.

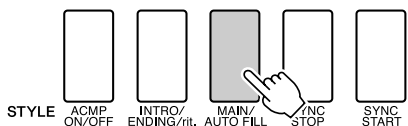

When the fill-in is finished, it leads smoothly into the selected main section A/B.

8 Press the [INTRO/ENDING/rit.] button.

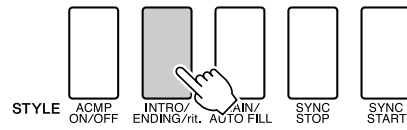

This switches to the ending section.

When the ending is finished, the auto accompaniment stops automatically. You can have the ending gradually slow down (ritardando) by pressing the [INTRO/ENDING/rit.] button again while the ending is playing back.

● **Synchro Stop**

When this function is selected the accompaniment style will only play while you are playing chords in the accompaniment range of the keyboard. Style playback will stop when you release the keys. To turn the function on, press the [SYNC STOP] button.

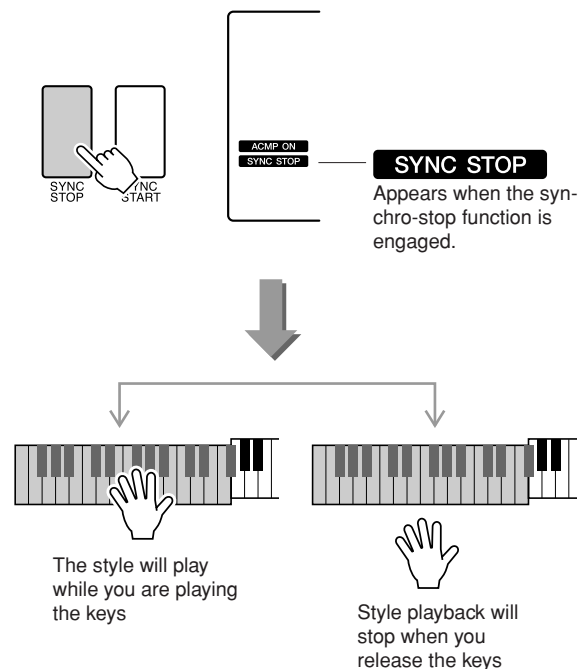

Adjusting the Style Volume

Press the [STYLE] button to engage the style function.

1 Press the [FUNCTION] button.

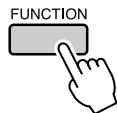

2 Use the CATEGORY [▲] and [▼] buttons to select the Style Volume item.

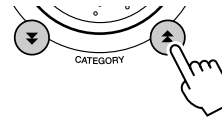

3 Use the dial to set the style volume between 000 and 127.

Setting the Split Point

The initial default split point is key number 54 (the F#2 key), but you can change it to another key using the procedure described below.

1 Press the [FUNCTION] button.

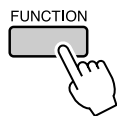

2 Use the CATEGORY [▲] and [▼] buttons to select the Split point item.

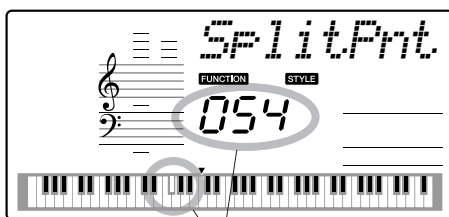
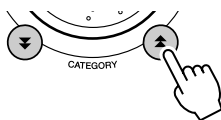

Split point

3 Use the dial to set the split point to any key from 000 (C-2) through 127 (G8).

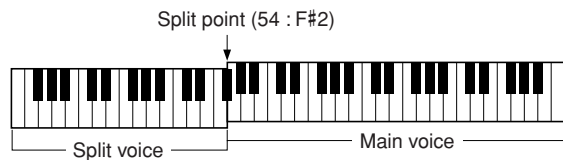

NOTE

- When you change the split point the auto-accompaniment split point also changes.
- The split point cannot be changed during a song lesson.
- The split voice sounds when the split-point key is played.

Play a Style with Chords but No Rhythm (Stop Accompaniment)

When auto accompaniment is on (the ACMP ON icon is showing) and Synchro Start is off, you can play chords in the left-hand accompaniment range of the keyboard while the style is stopped and still hear the accompaniment chords. This is “Stop Accompaniment”, and any of the chord fingerings recognized by the instrument can be used (page 24).

Press the [STYLE] button to engage the style function, then press the [ACMP ON/OFF] button.

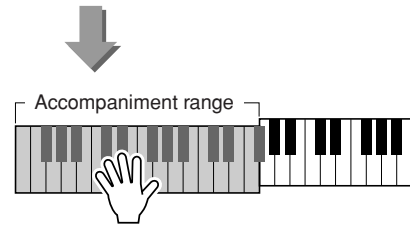
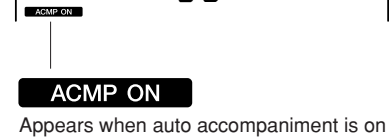
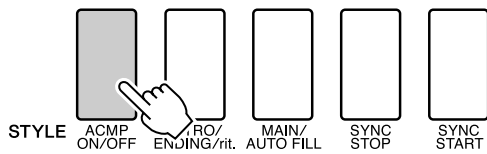

Playing Styles Using the Entire Keyboard

In “Play Along with a Style” on page 20 we described a method of playing styles in which chords were detected only to the left of the keyboard split point. By making the settings described below, however, chord detection for style accompaniment occurs over the entire range of the keyboard, allowing for even more dynamic style performance. In this mode only chords played in the normal way (page 24) can be detected.

1 Press the [FUNCTION] button.

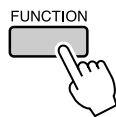

2 Use the CATEGORY [▲] and [▼] buttons to select the function “Chord Fingering”.

“ChdFing” will be shown in the display for a few seconds, then the currently selected Chord Fingering type will appear.

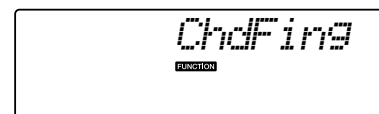
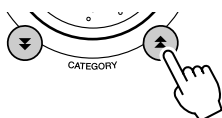

3 Use the dial to select 2 “FullKbd”.

Loading Style Files

This instrument features 160 internal styles, but other styles, such as those provided on the CD-ROM and others that can be obtained from the internet (only styles with the “.sty” suffix), can be loaded into style number 161 and used in the same way as the internal styles.

In order to use the style file load function, the file must already have been transferred from the computer to the instrument. The procedure for transferring files from a computer to the instrument is described on page 82 (“Transferring Data between the Computer and Instrument”).

The procedure described below loads a style file that has already been transferred from a computer to the instrument into style number 161.

1 Press the [FUNCTION] button.

The currently selected function will appear in the display.

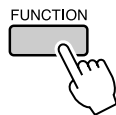

2 Press the CATEGORY [▲] and [▼] buttons as many times as necessary to select the style file load function “Sff Load”.

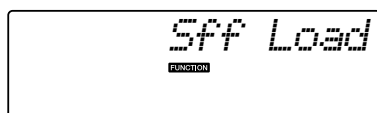
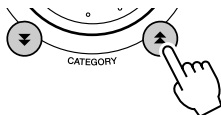

After about 2 seconds the name of a loadable style file will appear in the display.

If multiple loadable style files have been transferred to the instrument, you can use the dial or the [+] and [-] buttons to select the other files in sequence.

3 Execute the load operation.

With the name of the style file you want to load shown in the display, press the number [0] button.

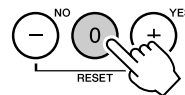

4 A confirmation message for the load operation will appear. Press the [+ / YES] button to actually load the file.

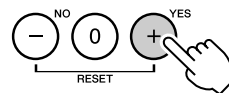

Chord Basics

Two or more notes played together constitute a “chord”.

The most basic chord type is the “triad” consisting of three notes: the root, third, and fifth degrees of the corresponding scale. A C major triad, for example, is made up of the notes C (the root), E (the third note of the C major scale), and G (the fifth note of the C major scale).

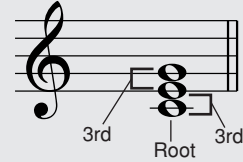

In the C major triad shown above, the lowest note is the “root” of the chord (this is the chord’s “root position” ... using other chord notes for the lowest note results in “inversions”). The root is the central sound of the chord, which supports and anchors the other chord notes.

The distance (interval) between adjacent notes of a triad in root position is either a major or minor third.

Major third—four half steps (semitones)

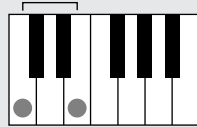

Minor third—three half steps (semitones)

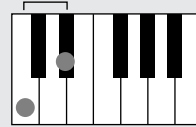

The lowest interval in our root-position triad (between the root and the third) determines whether the triad is a major or minor chord, and we can shift the highest note up or down by a semitone to produce two additional chords, as shown below.

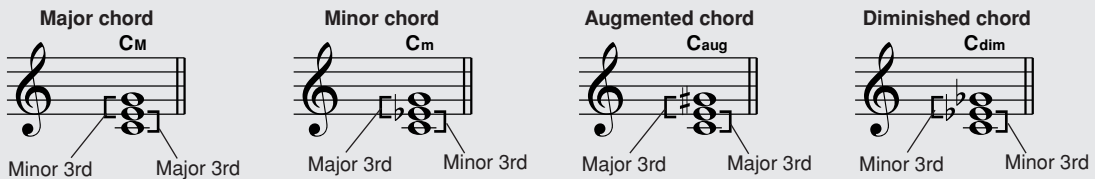

The basic characteristics of the chord sound remain intact even if we change the order of the notes to create different inversions. Successive chords in a chord progression can be smoothly connected, for example, by choosing the appropriate inversions (or chord “voicings”).

● Reading Chord Names

Chord names tell you just about everything you need to know about a chord (other than the inversion/voicing). The chord name tells you what the root of the chord is, whether it is a major, minor, or diminished chord, whether it requires a major or flatted seventh, what alterations or tensions it uses ... all at a glance.

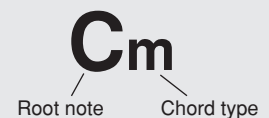

● Some Chord Types (These are just some of the “Standard” chord types recognized by the DGX-230/YPG-235.)

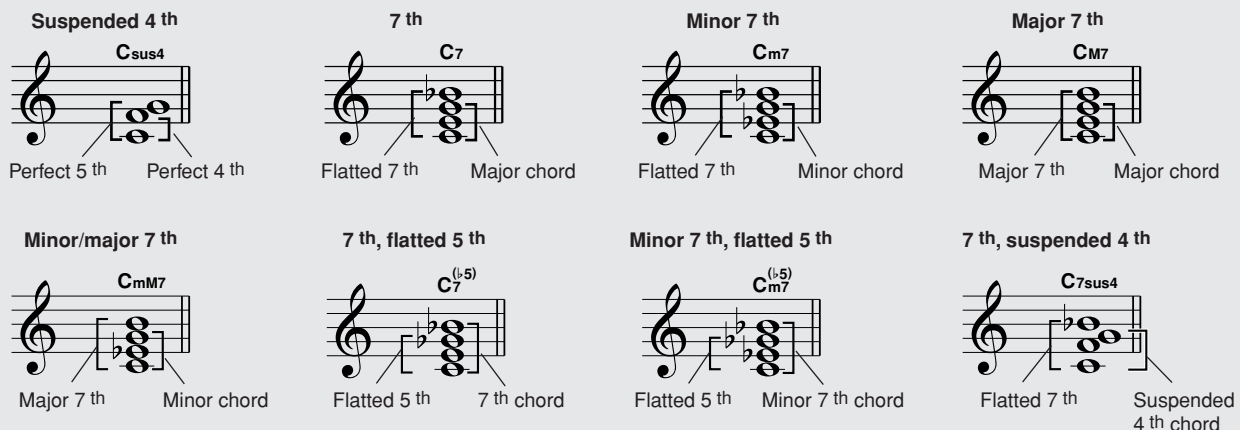

■ Recognized Standard Chords.....

All chords in the chart are “C-root” chords.

Chord Name/[Abbreviation]	Normal Voicing	Chord (C)	Display
Major [M]	1 - 3 - 5	C	C
Add ninth [(9)]	1 - 2 - 3 - 5	C ⁽⁹⁾	C(9)
Sixth [6]	1 - (3) - 5 - 6	C ₆	C6
Sixth ninth [6(9)]	1 - 2 - 3 - (5) - 6	C ₆ ⁽⁹⁾	C6(9) *
Major seventh [M7]	1 - 3 - (5) - 7 or 1 - (3) - 5 - 7	C _{M7}	CM7
Major seventh ninth [M7(9)]	1 - 2 - 3 - (5) - 7	C _{M7} ⁽⁹⁾	CM7(9) *
Major seventh add sharp eleventh [M7(#11)]	1 - (2) - 3 - #4 - 5 - 7 or 1 - 2 - 3 - #4 - (5) - 7	C _{M7} ^(#11)	CM7(#11) *
Flatted fifth [(b5)]	1 - 3 - b5	C ^(b5)	C ^{b5} *
Major seventh flatted fifth [M7b5]	1 - 3 - b5 - 7	C _{M7} ^(b5)	CM7 ^{b5} *
Suspended fourth [sus4]	1 - 4 - 5	C _{sus4}	Csus4
Augmented [aug]	1 - 3 - #5	C _{aug}	Caug
Major seventh augmented [M7aug]	1 - (3) - #5 - 7	C _{M7aug}	CM7aug *
Minor [m]	1 - b3 - 5	C _m	Cm
Minor add ninth [m(9)]	1 - 2 - b3 - 5	C _m ⁽⁹⁾	Cm(9)
Minor sixth [m6]	1 - b3 - 5 - 6	C _{m6}	Cm6
Minor seventh [m7]	1 - b3 - (5) - b7	C _{m7}	Cm7
Minor seventh ninth [m7(9)]	1 - 2 - b3 - (5) - b7	C _{m7} ⁽⁹⁾	Cm7(9)
Minor seventh add eleventh [m7(11)]	1 - (2) - b3 - 4 - 5 - (b7)	C _{m7} ⁽¹¹⁾	Cm7(11) *
Minor major seventh [mM7]	1 - b3 - (5) - 7	C _{mM7}	CmM7
Minor major seventh ninth [mM7(9)]	1 - 2 - b3 - (5) - 7	C _{mM7} ⁽⁹⁾	CmM7(9) *
Minor seventh flatted fifth [m7b5]	1 - b3 - b5 - b7	C _{m7} ^(b5)	Cm7 ^{b5}
Minor major seventh flatted fifth [mM7b5]	1 - b3 - b5 - 7	C _{mM7} ^(b5)	CmM7 ^{b5} *
Diminished [dim]	1 - b3 - b5	C _{dim}	Cdim
Diminished seventh [dim7]	1 - b3 - b5 - 6	C _{dim7}	Cdim7
Seventh [7]	1 - 3 - (5) - b7 or 1 - (3) - 5 - b7	C ₇	C7
Seventh flatted ninth [7(b9)]	1 - b2 - 3 - (5) - b7	C ₇ ^(b9)	C7(b9)
Seventh add flatted thirteenth [7(b13)]	1 - 3 - 5 - b6 - b7	C ₇ ^(b13)	C7(b13)
Seventh ninth [7(9)]	1 - 2 - 3 - (5) - b7	C ₇ ⁽⁹⁾	C7(9)
Seventh add sharp eleventh [7(#11)]	1 - (2) - 3 - #4 - 5 - b7 or 1 - 2 - 3 - #4 - (5) - b7	C ₇ ^(#11)	C7(#11)
Seventh add thirteenth [7(13)]	1 - 3 - (5) - 6 - b7	C ₇ ⁽¹³⁾	C7(13)
Seventh sharp ninth [7(#9)]	1 - #2 - 3 - (5) - b7	C ₇ ^(#9)	C7(#9)
Seventh flatted fifth [7b5]	1 - 3 - b5 - b7	C _{7b5}	C7 ^{b5} *
Seventh augmented [7aug]	1 - 3 - #5 - b7	C _{7aug}	C7aug
Seventh suspended fourth [7sus4]	1 - 4 - (5) - b7	C _{7sus4}	C7sus4
Suspended second [sus2]	1 - 2 - 5	C _{sus2}	C *

* These chords are not shown in the Dictionary function.

NOTE

- Notes in parentheses can be omitted.
- Playing two same root keys in the adjacent octaves produces accompaniment based only on the root.
- A perfect fifth (1+5) produces accompaniment based only on the root and fifth which can be used with both major and minor chords.
- The chord fingerings listed are all in “root” position, but other inversions can be used—with the following exceptions: m7, m7^{b5}, 6, m6, sus4, aug, dim7, 7^{b5}, 6(9), sus2.

NOTE

- Inversion of the 7sus4 and m7(11) chords are not recognized if the notes shown in parentheses are omitted.
- The auto accompaniment will sometimes not change when related chords are played in sequence (e.g. some minor chords followed by the minor seventh).
- Two-note fingerings will produce a chord based on the previously played chord.

Looking Up Chords Using the Chord Dictionary

The Dictionary function is essentially a built-in “chord book” that shows you the individual notes of chords. It is ideal when you know the name of a certain chord and want to quickly learn how to play it.

- 1 Press and hold the LESSON [START] button for longer than a second.

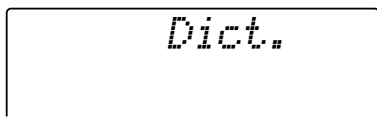
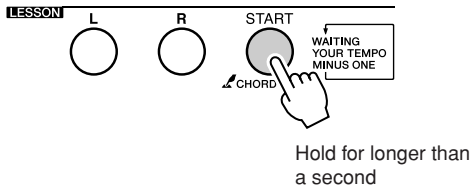

- 2 As an example, we'll learn how to play a GM7 (G major seventh) chord. Press the “G” key in the section of the keyboard labeled “ROOT”. (The note doesn't sound.) The root note you set is shown in the display.

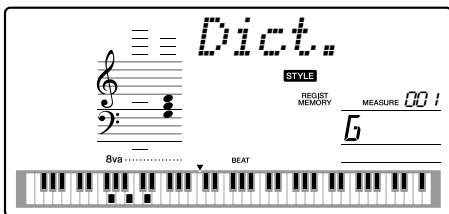
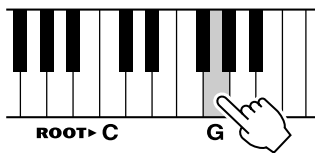

- 3 Press the “M7” (major seventh) key in the section of the keyboard labeled “CHORD TYPE”. (The note doesn't sound.) The notes you should play for the specified chord (root note and chord type) are shown in the display, both as notation and in the keyboard diagram.

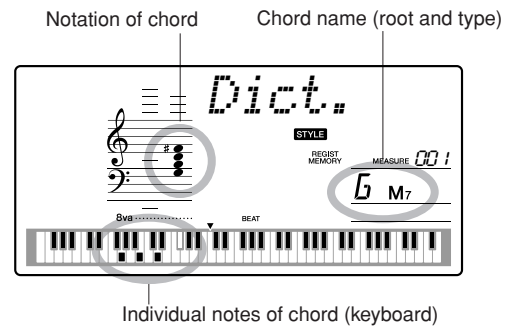
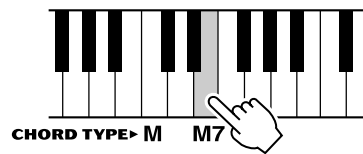

To call up possible inversions of the chord, press the [+]/[-] buttons.

NOTE

- About major chords: Simple major chords are usually indicated only by the root note. For example, “C” refers to C major. However, when specifying major chords here, make sure to select “M” (major) after pressing the root note.

- 4 Try playing a chord in the auto accompaniment section of the keyboard, checking the indications in the display. When you've played the chord properly, a bell sound signals your success and the chord name in the display flash.

Song Volume

1 Press the [FUNCTION] button.

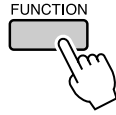

2 Use the CATEGORY [▲] and [▼] buttons to select the Song Volume item.

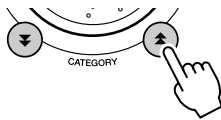

3 Use the dial to set the song volume between 000 and 127.

NOTE

• Song volume can be adjusted while a song is selected.

A-B Repeat

You can specify a section of a song—"A" is the start point and "B" is the end point—for repeat playback.



1 Play the song (page 25) and press the [A-B REPEAT] button at the beginning of the section you want to repeat (the "A" point).

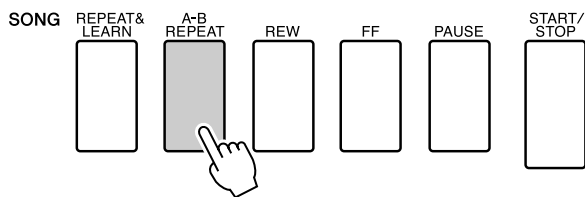

2 Press the [A-B REPEAT] button a second time at the end of the section you want to repeat (the "B" point).

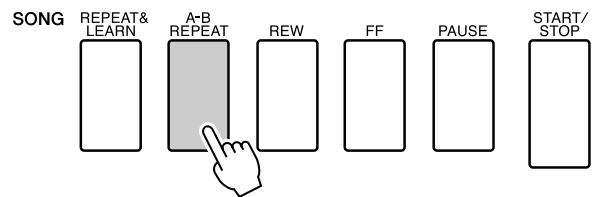

3 The specified A-B section of the song will now play repeatedly.

You can stop repeat playback at any time by pressing the [A-B REPEAT] button.

NOTE

- The repeat start and end points can be specified in one-measure increments.
- The current measure number is shown in the display during playback.
- If you want to set the start point "A" at the very beginning of the song press the [A-B REPEAT] button before starting playback of the song.

Muting Independent Song Parts

Each “track” of a song plays a different part of the song—melody, percussion, accompaniment, etc. You can mute individual tracks and play the muted part on the keyboard yourself, or simply mute tracks other than the ones you want to listen to. Use the SONG MEMORY [1]–[5] and [A] buttons to mute or un-mute the corresponding tracks. The track number in the display disappears when that track is muted. Refer to page 45 for information about the song track configuration.

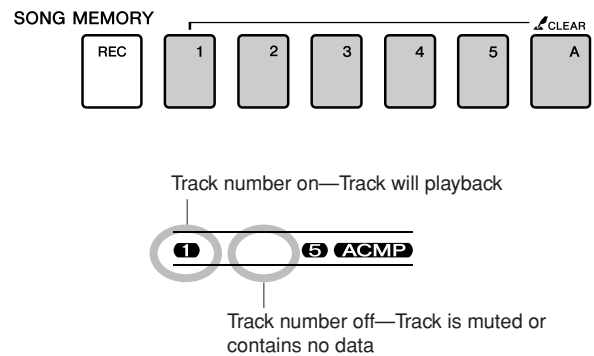

Change the Melody Voice

You can change a song’s melody voice to any other voice you prefer.

NOTE
• You cannot change the melody voice of a user song.

- 1** Select the song and play it.
- 2** Rotate the dial to select the voice you want to listen to after pressing the [VOICE] button.



- 3** Press the [VOICE] button for longer than a second. “SONG MELODY VOICE” appears in the display for a few seconds, indicating that the voice selected in step #2 has replaced the song’s original melody voice.

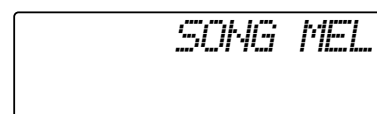
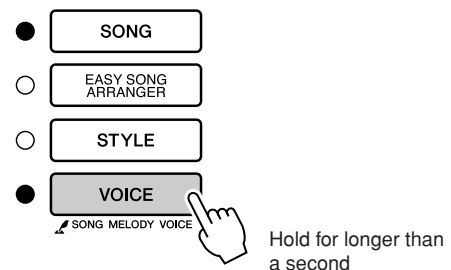

Memorize Your Favorite Panel Settings

This instrument has a Registration Memory feature that lets you save your favorite settings for easy recall whenever they're needed. Up to 16 complete setups can be saved (8 banks of two setups each).

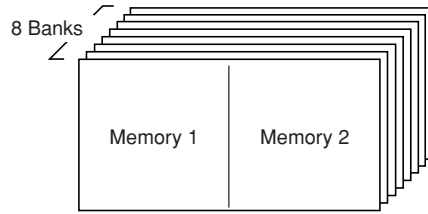

Up to 16 presets (eight banks of two each) can be memorized.

Saving to the Registration Memory

- 1 Set the panel controls as required—select a voice, accompaniment style, etc.
- 2 Press the [MEMORY/BANK] button. A bank number will appear in the display when you release the button.

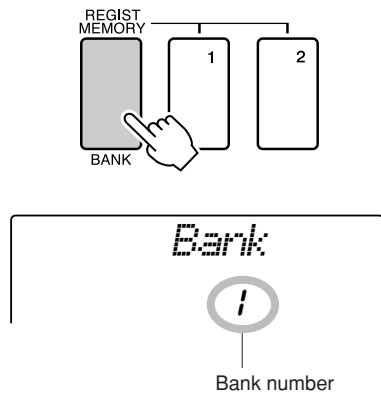

- 3 Use the dial or the [1]–[8] number buttons to select a bank number from 1 to 8.

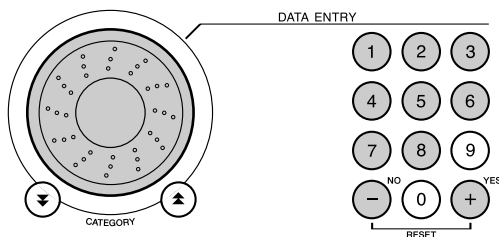

NOTE

• Data cannot be saved to the registration memory during song playback.

- 4 Press the REGIST MEMORY [1] or [2] button while holding the [MEMORY/BANK] button to store the current panel settings to the specified registration memory.

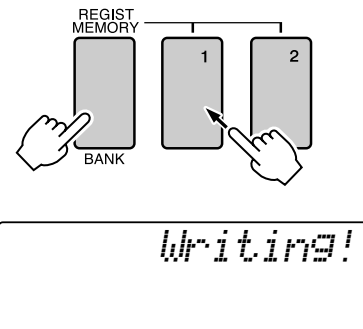

NOTE

• If you select a Registration Memory number that already contains data, the previous data is deleted and overwritten by the new data.

CAUTION

• Do not turn off the power while saving settings to the registration memory, otherwise the data may be damaged or lost.

Recalling a Registration Memory

- 1 Press the [MEMORY/BANK] button. A bank number will appear in the display when you release the button.

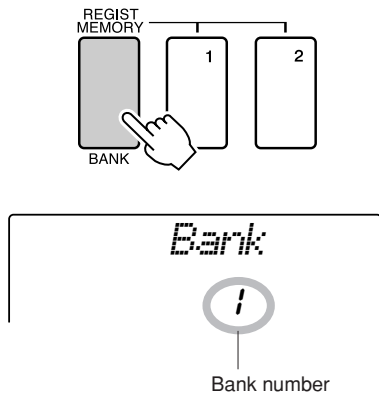

- 2 Use the dial or the [1]–[8] number buttons to select bank you want to recall.

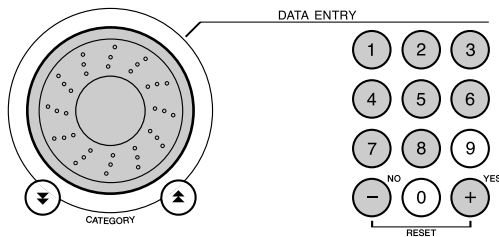

- 3 Press the REGIST MEMORY button, [1] or [2], containing the settings you want to recall. The recalled REGIST MEMORY number appears in the display for a few seconds. The panel controls will be instantly set accordingly.

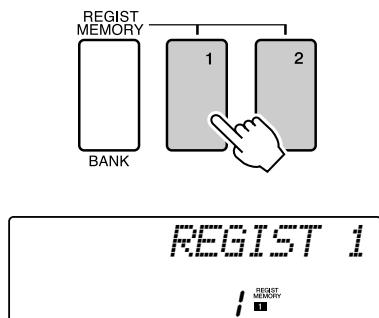

● Settings That Can be Saved to the Registration Memory

• Style settings*

Style number, Auto Accompaniment ON/OFF, Split Point, Style settings (Main A/B), Style Volume, Tempo, Chord Fingering

• Voice settings

Main Voice setting (Voice number, Volume, Octave, Pan, Reverb Level, Chorus Level), Dual Voice settings (Dual ON/OFF, Voice number, Volume, Octave, Pan, Reverb Level, Chorus Level), Split Voice settings (Split ON/OFF, Voice number, Volume, Octave, Pan, Reverb Level, Chorus Level)

• Effect settings

Reverb Type, Chorus Type, Panel Sustain ON/OFF,

• Harmony settings

Harmony ON/OFF, Harmony Type, Harmony Volume

• Other settings

Transpose, Pitch Bend Range

* Style settings are not available for Registration Memory when using the Song features.

The Functions

The “Functions” provide access to a range of detailed instrument parameters for tuning, setting the split point, and adjusting the voices and effects. Take a look at the function list starting on the opposite page. There are 47 function parameters in all. When you locate a function you want to set up, simply select the function’s display name (shown to the right of the function name in the list) and adjust as required.

Selecting and Setting Functions

1 Find the function you want to set in the list that begins on page 76.

2 Press the [FUNCTION] button.

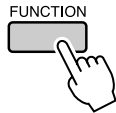

3 Select a function.

Press the CATEGORY [\blacktriangle] and [\blacktriangledown] buttons as many times as necessary until the function’s display name appears in the display.

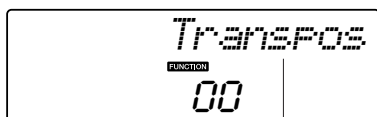
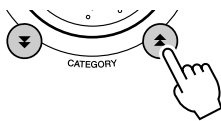

The selected function.

4 Use the dial, the [+] and [-] buttons, or the [0]–[9] number buttons to set the selected function as required.

The [+] and [-] buttons are used to make ON/OFF type settings: [+] = ON, [-] = OFF. In some cases the [+] button will initiate execution of the selected function, and the [-] will cancel the selection.

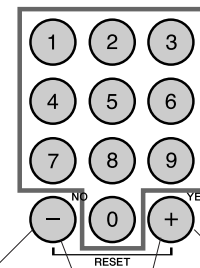
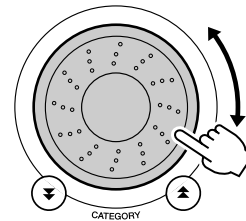

Direct numeric entry.

- Decrement value by 1.
- OFF
- Cancel
- Increment value by 1.
- ON
- Execute

Press simultaneously to recall the default setting.

Some Function settings are stored in memory as soon as they are changed. See “The Backup Parameters” on page 49 for information on the function settings that are stored on the instrument. To restore all initial factor default settings perform the “Backup Clear” procedure described in the “Initialization” section on page 49.

● Function Setting List

Setting	Item title	Range/Settings	Description
Style Volume	<i>StyleVol</i>	000–127	Determines the volume of the Style.
Song Volume	<i>SongVol</i>	000–127	Determines the volume of the Song.
Transpose	<i>TransPos</i>	-12–12	Determines the pitch of the instrument by semitone increments.
Tuning	<i>Tuning</i>	-100–100	Sets the pitch of the instrument's sound in 1-cent increments.
Pitch Bend Range	<i>PBRange</i>	01–12	Sets the pitch bend range in semitone increments.
Split Point	<i>SplitPnt</i>	000–127 (C-2–G8)	Determines the highest key for the Split voice and sets the Split “point”—in other words, the key that separates the Split (lower) and Main (upper) voices. The Split Point setting and Accompaniment Split Point setting are automatically set to the same value.
Touch Sensitivity	<i>TouchSns</i>	1(Soft), 2(Medium), 3(Hard), 4(Off)	Determines the sensitivity of the feature.
Fingering Chord	<i>ChdFing</i>	Multi(1), FullKbd(2)	Sets the chord detection mode. In the Multi Finger mode both standard chords and easy chords played to the left of the split point are detected. In the Full Keyboard mode standard chords played anywhere on the keyboard will be detected, and the notes played will be sound as well.
Main Voice Volume	<i>M. Volume</i>	000–127	Determines the volume of the Main voice.
Main Voice Octave	<i>M. Octave</i>	-2–+2	Determines the octave range for the Main voice.
Main Voice Pan	<i>M. Pan</i>	000 (left)– 64 (center)– 127 (right)	Determines the pan position of the Main voice in the stereo image. The value “0” results in the sound being panned full left; the value “127” results in the sound being panned full right.
Main Voice Reverb Level	<i>M. Reverb</i>	000–127	Determines how much of the Main voice's signal is sent to the Reverb effect.
Main Voice Chorus Level	<i>M. Chorus</i>	000–127	Determines how much of the Main voice's signal is sent to the Chorus effect.
Dual Voice	<i>D. Voice</i>	001–489	Selects the Dual voice.
Dual Voice Volume	<i>D. Volume</i>	000–127	Determines the volume of the Dual voice.
Dual Voice Octave	<i>D. Octave</i>	-2–+2	Determines the octave range for the Dual voice.
Dual Voice Pan	<i>D. Pan</i>	000 (left)– 64 (center)– 127 (right)	Determines the pan position of the Dual voice in the stereo image. The value “0” results in the sound being panned full left; the value “127” results in the sound being panned full right.
Dual Voice Reverb Level	<i>D. Reverb</i>	000–127	Determines how much of the Dual voice's signal is sent to the Reverb effect.
Dual Voice Chorus Level	<i>D. Chorus</i>	000–127	Determines how much of the Dual voice's signal is sent to the Chorus effect.
Split Voice	<i>S. Voice</i>	001–489	Selects the Split voice.
Split Voice Volume	<i>S. Volume</i>	000–127	Determines the volume of the Split voice.
Split Voice Octave	<i>S. Octave</i>	-2–+2	Determines the octave range for the Split voice.
Split Voice Pan	<i>S. Pan</i>	000 (left)– 64 (center)– 127 (right)	Determines the pan position of the Split voice in the stereo image. The value “0” results in the sound being panned full left; the value “127” results in the sound being panned full right.
Split Voice Reverb Level	<i>S. Reverb</i>	000–127	Determines how much of the Split voice's signal is sent to the Reverb effect.
Split Voice Chorus Level	<i>S. Chorus</i>	000–127	Determines how much of the Split voice's signal is sent to the Chorus effect.

Setting	Item title	Range/Settings	Description
Reverb Type	<i>Reverb</i>	01–10	Determines the Reverb type, including off (10). (See the list on page 109)
Chorus Type	<i>Chorus</i>	01–05	Determines the Chorus type, including off (05). (See the list on page 109)
Panel Sustain	<i>Sustain</i>	ON/OFF	Determines whether or not panel sustain is always applied to the MAIN/ DUAL voices. Panel sustain is applied continuously when ON, or not applied when OFF. (page 59)
Master EQ Type	<i>MasterEQ</i>	Speaker1, Speaker2, Headphone, Line Out1, Line Out2	Sets the equalizer applied to the speaker output for optimum sound in different listening situations.
Harmony Type	<i>HarmType</i>	01–26	Determines the Harmony type. (See the list on page 109)
Harmony Volume	<i>HarmVol</i>	000–127	Determines the volume of the Harmony effect.
Performance assistant technology Type	<i>PAT Type</i>	CHORD(1), CHD/FREE(2):	Determines the performance assistant technology type.
Style File Load	<i>Stff Load</i>	001–nnn	Loads a Style file.
PC mode	<i>PC mode</i>	PC1/PC2/OFF	Optimizes the MIDI settings when you connect to a computer (page 81).
Local On/Off	<i>Local</i>	ON/OFF	Determines whether the instrument's keyboard controls the internal tone generator (ON) or not (OFF). (page 80)
External Clock	<i>ExtClock</i>	ON/OFF	Determines whether the instrument synchronizes to the internal clock (OFF) or an external clock (ON). (page 80)
Keyboard Out	<i>KbdOut</i>	ON/OFF	Determines whether keyboard performance data of the instrument is transmitted (ON) or not (OFF).
Style Out	<i>StyleOut</i>	ON/OFF	Determines whether Style data is transmitted (ON) via USB or not (OFF) during Style playback.
Song Out	<i>SongOut</i>	ON/OFF	Determines whether User Song is transmitted (ON) via USB or not (OFF) during Song playback.
Initial Send	<i>InitSend</i>	YES/NO	Lets you send the data of the panel settings to a computer. Press [+] to send, or press [-] to cancel.
Time Signature Numerator	<i>Timesign</i>	00–60	Determines the time signature of the Metronome.
Time Signature Denominator	<i>TimesignD</i>	Half note, Quarter note, Eighth note, Sixteenth note	Sets the length of each metronome beat.
Metronome Volume	<i>MtrVol</i>	000–127	Determines the volume of the Metronome.
Lesson Track (R)	<i>R-Part</i>	GuideTrack 1–16	Determines the guide track number for your right hand lesson. The setting is only effective for songs in SMF format 0 transferred from a computer.
Lesson Track (L)	<i>L-Part</i>	GuideTrack 1–16	Determines the guide track number for your left hand lesson. The setting is only effective for songs in SMF format 0 transferred from a computer.
Grade	<i>Grade</i>	ON/OFF	Determines whether the Grade function is on or off.
Demo Cancel	<i>D-Cancel</i>	ON/OFF	Determines whether Demo cancel is enabled or not. When this is set to ON, the Demo Song will not play, even if the [DEMO] button is pressed.

* All these settings can be conveniently reset to their initial default values by pressing the [+] and [-] buttons simultaneously. (The exception to this is Initial Send, which is an operation, not a setting.)

Connecting to a Computer

Nearly all of the electronic musical instruments made today—particularly synthesizers, sequencers and computer music related devices—use MIDI. MIDI is a worldwide standard that allows these devices to send and receive performance and setting data. Naturally, this instrument lets you save or send your keyboard performance as MIDI data, as well as the songs, styles and panel settings.

The potential MIDI holds for your live performances and music creation/production is enormous—simply by connecting this instrument to a computer and transmitting MIDI data. In this section, you'll learn the basics of MIDI and the specific MIDI functions provided by this instrument.

What Is MIDI?

No doubt you have heard the terms “acoustic instrument” and “digital instrument”. In the world today, these are the two main categories of instruments. Let's consider a grand piano and a classical guitar as representative acoustic instruments. They are easy to understand. With the piano, you strike a key, and a hammer inside hits some strings and plays a note. With the guitar, you directly pluck a string and the note sounds. But how does a digital instrument go about playing a note?

● Acoustic guitar note production

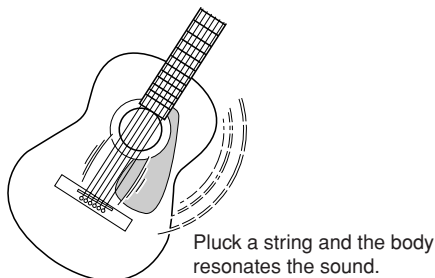

● Digital instrument note production

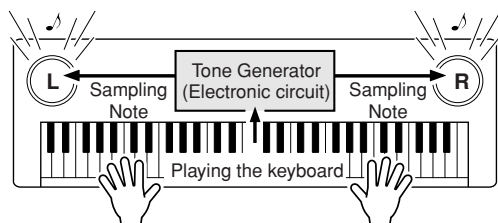

Based on playing information from the keyboard, a sampling note stored in the tone generator is played through the speakers.

As shown in the illustration above, in an electronic instrument the sampling note (previously recorded note) stored in the tone generator section (electronic circuit) is played based on information received from the keyboard. So then what is the information from the keyboard that becomes the basis for note production?

For example, let's say you play a “C” quarter note using the grand piano sound on the instrument. Unlike an acoustic instrument that puts out a resonated note, the electronic instrument puts out information from the keyboard such as “with what voice”, “with which key”, “about how strong”, “when was it pressed”, and “when was it released”. Then each piece of information is changed into a number value and sent to the tone generator. Using these numbers as a basis, the tone generator plays the stored sampling note.

Example of Keyboard Information

Voice number (with what voice)	1 (grand piano)
Note number (with which key)	60 (C3)
Note on (when was it pressed) and note off (when was it released)	Timing expressed numerically (quarter note)
Velocity (about how strong)	120 (strong)

Your keyboard performance and all panel operations of this instrument are processed as MIDI data. The songs, auto accompaniment (styles), and User songs are also made up of MIDI data. MIDI is an acronym that stands for Musical Instrument Digital Interface and it allows different musical instruments and devices to instantly communicate with each other, via digital data. The MIDI standard is used all over the world and was designed to transmit performance data between electronic musical instruments (or computers). Thanks to MIDI, you can control one instrument from another and transmit performance data between the devices-taking your creative and performance potential to even higher levels.

MIDI messages can be divided into two groups: Channel messages and System messages.

● Channel Messages

This instrument is capable of handling 16 MIDI channels simultaneously—meaning it can play up to sixteen different instruments at the same time. Channel messages transmit information such as Note ON/OFF, Program Change, for each of the 16 channels.

Message Name	Instrument Operation/Panel Setting
Note ON/OFF	Performance data of the keyboard (contains note number and velocity data)
Program Change	Instrument selection (including bank select MSB/LSB, if necessary)
Control Change	Instrument settings (volume, pan, etc.)

● System Messages

This is data that is used in common by the entire MIDI system. System messages include messages like Exclusive Messages that transmit data unique to each instrument manufacturer and Realtime Messages that control the MIDI device.

Message Name	Instrument Operation/Panel Setting
Exclusive Message	Reverb/chorus settings, etc.
Realtime Messages	Start/stop operation

Connecting a Personal Computer

The following functions become available when this instrument is connected to a computer.

- Performance data can be transferred between the instrument and the computer (page 80).
- Files can be transferred between the instrument and the computer (page 82).

The connection procedure is as follows:

1 Install the USB-MIDI driver on your computer.

The USB-MIDI driver is included on the CD-ROM. Installation of the USB-MIDI driver is described on page 85.

2 Connect the USB terminal of the computer to the USB terminal on the instrument using an AB type USB cable (USB cable sold separately).

The supplied CD-ROM also includes a Musicsoft Downloader application that allows you to transfer song files from your computer to the instrument's flash memory. For instructions about how to install Musicsoft Downloader and how to transfer song files, see page 83.

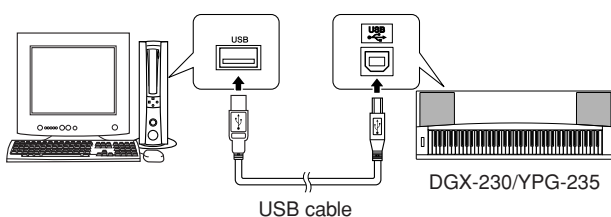

■ Precautions when using the USB terminal

When connecting the computer to the USB terminal, make sure to observe the following points. Failing to do so risks freezing the computer and corrupting or losing the data. If the computer or the instrument freezes, restart the application software or the computer OS, or turn the power to the instrument off then on again.

⚠ CAUTION

- Use an AB type USB cable of less than about 3 meters.
- Before connecting the computer to the USB terminal, exit from any power-saving mode of the computer (such as suspended, sleep, standby).
- Before turning on the power to the instrument, connect the computer to the USB terminal.
- Execute the following before turning the power to the instrument on/off or plugging/unplugging the USB cable to/from the USB terminal.
 - Quit any open application software on the computer.
 - Make sure that data is not being transmitted from the instrument. (Data is transmitted whenever you play on the keyboard or play back a song, etc.)
- While a USB device is connected to the instrument, you should wait for six seconds or more between these operations: (1) when turning the power of the instrument off then on again, or (2) when alternately connecting/disconnecting the USB cable.

Transferring Performance Data to and from a Computer

By connecting the instrument to a computer, the instrument's performance data can be used on the computer, and performance data from the computer can be played on the instrument.

- When the instrument is connected with computer, it transmits/receives performance data.

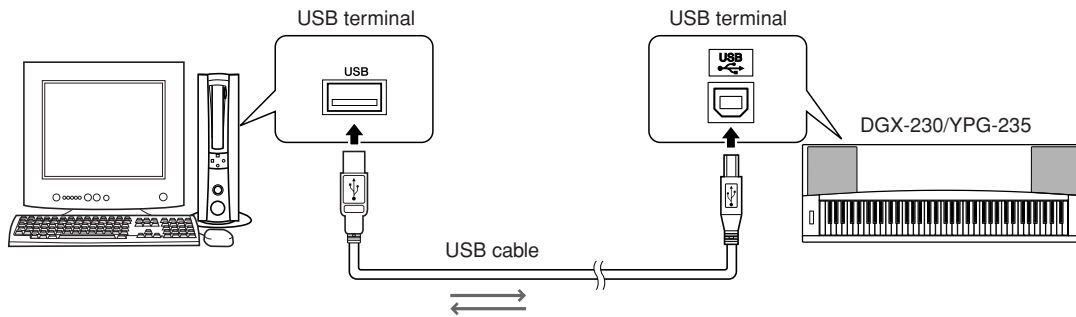

MIDI settings

These settings pertain to performance data transmission and reception.

Item	Range/Settings	Description
Local	ON/OFF	Local control determines whether or not notes played on the instrument are sounded by its internal tone generator system: the internal tone generator is active when local control is on, and inactive when local control is off.
External Clock	ON/OFF	These settings determine whether the instrument is synchronized to its own internal clock (OFF), or to a clock signal from an external device (ON).
Keyboard Out	ON/OFF	These settings determine whether keyboard performance data of the instrument is transmitted (ON) or not (OFF).
Style Out	ON/OFF	These settings determine whether Style data is transmitted (ON) or not (OFF) during Style playback.
Song Out	ON/OFF	These settings determine whether User Song is transmitted (ON) or not (OFF) during Song playback.

CAUTION

• If you can't get any sound out of the instrument, this most likely may be caused by Local Control being set to off.

CAUTION

• If External Clock is ON and no clock signal is being received from an external device, the song, style, and metronome functions will not start.

1 Press the [FUNCTION] button.

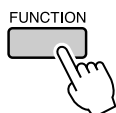

2 Use the CATEGORY [▲] and [▼] buttons to select the item you want to change its value.

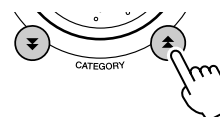

3 Use the dial to select ON or OFF.

■ PC Mode

A number of MIDI settings need to be made when you want to transfer performance data between the computer and the instrument. The PC Mode item can conveniently make multiple settings for you in one operation. Three settings are available: PC1, PC2, and OFF.

This setting is not necessary when transferring song or backup files between the computer and the instrument.

* Set the PC mode to PC2 when using Digital Music Notebook.

	PC1	PC2*	OFF
Local	OFF	OFF	ON
External Clock	ON	OFF	OFF
Song Out	OFF	OFF	OFF
Style Out	OFF	OFF	OFF
Keyboard Out	OFF	ON	ON

1 Press and hold the [DEMO] button for longer than a second so that the PC Mode item appears.

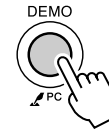

2 Use the dial to select PC1, PC2, or OFF.

NOTE

- When the PC2 setting is selected the instrument's style, song, demo, song recording, and lesson features cannot be used.

NOTE

- You can also access the PC Mode item by first pressing the [FUNCTION] button and then using the CATEGORY [▲] and [▼] buttons to locate it (page 75).

Remote Control of MIDI Devices

You can also use this instrument as a remote control device for the Digital Music Notebook application on your computer (via the USB connection)—controlling playback, stop and transport functions from the panel.

■ Remote control keys

To use the remote control functions, simultaneously hold down the lowest two keys on the keyboard (E0 and F#0) and press the appropriate key (shown below).

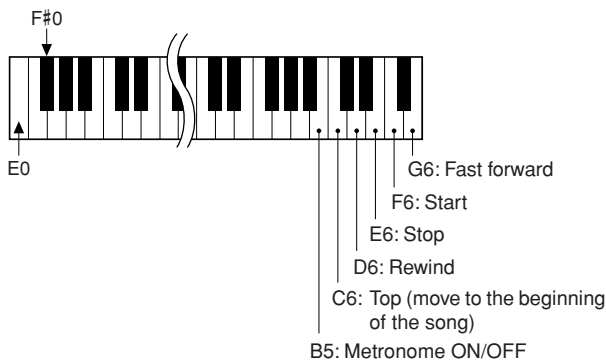

NOTE

- Remote control of MIDI devices will function independently of the PC2 mode.

Initial Send

This function lets you send the panel setup data to a computer. Before you record performance data to a sequencer application running on your computer, it is a good idea to first send and record the panel setup data before the actual performance data.

1 Press the [FUNCTION] button.

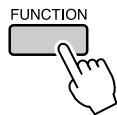

2 Use the CATEGORY [▲] and [▼] buttons to select the Initial Send item.

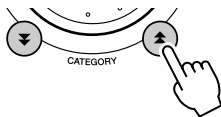

3 Press [+ / YES] to send, or press [- / NO] to cancel.

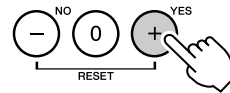

Transferring Data between the Computer and Instrument

Songs, styles, or Music Database files residing on a computer or the supplied CD-ROM, can be transferred to the instrument. Backup files can also be transferred from the instrument to the computer and back.

In order to transfer files between your computer and the instrument you will need to install the Musicsoft Downloader application and the USB-MIDI Driver included on the Accessory CD-ROM on your computer. Refer to the Accessory CD-ROM Installation Guide on page 85 for installation details.

● **Data that can be transferred from a computer to this instrument.**

- Data Capacity: 373KB
256 files total for the Song, Style and Music Database
- Data Format
Song: .mid SMF format 0/1
Style: .sty
Music Database: .mfd
Backup File: 08PG76.bup

● **What is SMF (Standard MIDI File)?**

The SMF (Standard MIDI File) format is one of the most common and widely compatible sequence formats used for storing sequence data. There are two variations: Format 0 and Format 1. A large number of MIDI devices are compatible with SMF Format 0, and most commercially available MIDI sequence data is provided in SMF Format 0.

■ **With the Musicsoft Downloader You Can.**

- Transfer files from the computer to the instrument's flash memory.

⇒ **refer to the procedure described on page 83.**

The procedure for transferring songs included on the Accessory CD-ROM from your computer to the instrument is given as an example.

- Backup files can be transferred from the instrument to a computer and back.
⇒ refer to the procedure described on page 84.

Use the Musicsoft Downloader application with Internet Explorer 5.5 or higher.

■ Use Musicsoft Downloader To Transfer Songs From the Accessory CD-ROM To the Instrument's flash memory.....

NOTE

- If a song or style is being played, stop playback before proceeding.

- 1 Install the Musicsoft Downloader and USB-MIDI driver to your computer, then connect the computer and the instrument (page 87).
- 2 Insert the included CD-ROM into the CD-ROM drive.
A start window will appear automatically.
- 3 Double-click the Musicsoft Downloader shortcut icon that is created on the desktop.
This will launch the Musicsoft Downloader application and the main window will appear.

NOTE

- The instrument cannot be operated while the Musicsoft Downloader is running.

- 4 Click the "Add File" button and the Add File window will appear.
- 5 Click the button to the right of "Look in" and select the CD-ROM drive from the drop-down menu that appears. Double-click the "SampleData" Folder on the window. Select the file from the "SongData" Folder you want to transfer to the instrument, and click "Open".

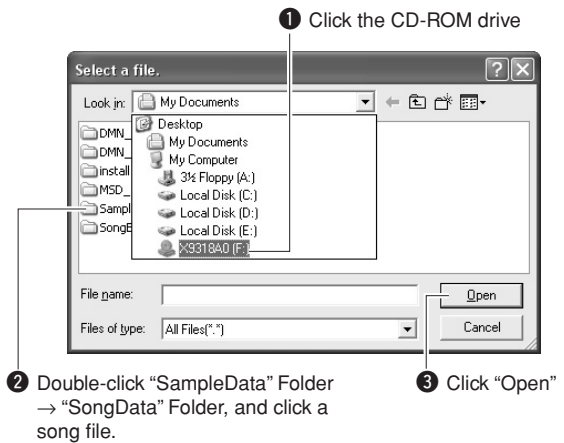

At this point you can select a Style or Music Database file on the computer or CD-ROM and transfer it to the instrument in the same way as a song file.

6 A copy of the selected MIDI song file will appear in the "List of files stored temporarily" at the top of the window.

The memory medium will also be displayed at the bottom of the window to specify the destination for the transfer. Click the "Electronic Musical Instruments", and then "Flash memory".

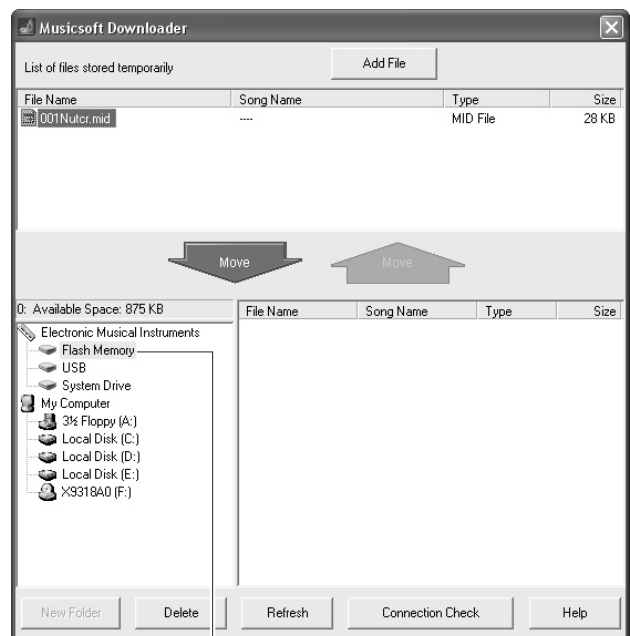

- 1 Click the "Electronic Musical Instruments", and then "Flash Memory"

7 After selecting the file in the “List of files stored temporarily”, click the downward [Move] button and a confirmation message will appear. Click [OK] and the song will be transferred from the “List of files stored temporarily” to the instrument’s memory.

8 Close the window to end the Musicsoft Downloader.

NOTE

• End the Musicsoft Downloader to playback the file transferred from your computer.

9 To playback a song stored in flash memory, press the [SONG] button. Use the dial to select the song you want to play, then press the [START/STOP] button to start playback.

CAUTION

• Do not unplug the USB cable during a data transfer. Not only will the data not be transferred and saved, but operation of the memory media may become unstable and its contents may disappear completely when the power is turned on or off.

CAUTION

• Store data can be lost due to equipment malfunction or improper operation. For safety we recommend that you keep a copy of all important data stored on your computer.
• We recommend that you use a power adaptor rather than batteries when transferring data. The data can be corrupted if the batteries fail during the transfer.

● To Use transferred Songs For Lessons...

In order to use songs (only SMF format 0) transferred from a computer for lessons it is necessary to specify which channels are to be played back as the right-hand and left-hand parts.

- 1** Press the [SONG] button and select the song (036–) residing in flash memory for which you want to set the guide track.
- 2** Press the [FUNCTION] button.
- 3** Use the CATEGORY [▲] and [▼] buttons to select the R-Part or L-Part item.
- 4** Use the dial to select the channel you want to play back as the specified right- or left-hand part.

We recommend that you select channel 1 for the right-hand part and channel 2 for the left-hand part.

■ Transfer a backup file from the instrument to a computer...

You can use the Musicsoft Downloader to transfer “Backup Files” (page 49) including the five User Songs stored on the instrument, to a computer. If you click “Electronic Musical Instruments” in the Musicsoft Downloader display, and then “System Drive”, a file named “08PG76.BUP” will appear in the lower right corner of the Musicsoft Downloader display. This is the backup file. For details about how to transmit backup file using the Musicsoft Downloader application, refer to the Online help “Transferring Data Between the Computer and Instrument (for unprotected data)” section in the application.

NOTE

• Preset Song data cannot be transmitted from the instrument.

CAUTION

• The backup data, including the five User Songs is transmitted/received as a single file. As a result, all backup data will be overwritten every time you transmit or receive. Keep this in mind when transferring data.

CAUTION

• Do not rename the backup file on the computer. If you do so, it will not be recognized when transferred to the instrument.



Accessory CD-ROM Installation Guide

SPECIAL NOTICES

- The software and this manual are the exclusive copyrights of Yamaha Corporation.
- Use of the software and this manual is governed by the license agreement which the purchaser fully agrees to upon breaking the seal of the software packaging. (Please read carefully the Software Licensing Agreement at the end of this manual before installing the application.)
- Copying of the software or reproduction of this manual in whole or in part by any means is expressly forbidden without the written consent of the manufacturer.
- Yamaha makes no representations or warranties with regard to the use of the software and documentation and cannot be held responsible for the results of the use of this manual and the software.
- This disk containing the software is not meant for use with an audio/visual system (CD player, DVD player, etc.). Do not attempt to use the disk on equipment other than a computer.
- Future upgrades of application and system software and any changes in specifications and functions will be announced separately.
- The screen displays as illustrated in this manual are for instructional purposes, and may appear somewhat different from the screens which appear on your computer.

Important Notices about the CD-ROM

● Data Types

This CD-ROM includes application software. Please refer to page 87 for software installation instructions.

CAUTION

- *Do not attempt to play this CD-ROM on any playback device other than a computer. The resulting high-volume noise may cause hearing damage or damage to the playback device.*

● Operating System (OS)

The applications in this CD-ROM are provided in versions for Windows operating systems.

CD-ROM Contents



Folder Name		Application / Data Name	Contents
1	MSD_	Musicsoft Downloader	This application can be used to download MIDI song data from the Internet and transfer it from the computer to the instrument's memory.
2	DMN_	Digital Music Notebook	Digital Music Notebook is a combination music learning program and online service that makes it easy and fun to practice and master your favorite songs. You can use the convenient and powerful Digital Music Notebook functions with the demo song after installing Digital Music Notebook.
	DMN_FlashDemo	Digital Music Notebook Flash Demo	Full motion demo software which introduces all features of the Digital Music Notebook.
3	SongBook	Song Book	Includes score data for the 30 internal songs provided on the instrument as well as 70 MIDI songs provided on the CD-ROM. The exceptions are songs 1-11, 16, 20 and song 30 which is copyrighted. The scores for songs 9-11 are provided in this manual beginning on page 94.
4	USBdrv2k_	USB-MIDI Driver (Windows 2000/XP)	This driver software is necessary to connect MIDI devices to your computer via USB.
	USBdrvVista_	USB-MIDI Driver (Windows Vista/XP x64)	
	SampleData	SongData	These songs, styles, or music database can be transferred to the instrument and played or used with the instrument functions.
		StyleData	
		MDB	

In order to view PDF scores, you will need to install Adobe Reader in your computer. You can download the Adobe Reader. Please check the following URL: <http://www.adobe.com/>

■ Using the CD-ROM

Please read the Software License Agreement on page 113 before opening the CD-ROM package.

1 Check the system requirements to make sure that the software will run on your computer.

2 Insert the included CD-ROM into the CD-ROM drive.

The start window should appear automatically.

3 Install the USB-MIDI driver to the computer.

Refer to “Installing the USB-MIDI Driver” on page 87 for installation and setup instructions.

4 Connect the instrument to the computer.

The connection procedure is described on page 79.

5 Install the software.

Musicsoft Downloader:
See page 89.

6 Launch the software.

For further software operation refer to the online help supplied with the software.

Refer to the “Troubleshooting” on page 90 when you have trouble with installing the driver.

System Requirements

Application/Data	OS	CPU	Memory	Hard Disk	Display
Musicsoft Downloader	Windows 2000/ XP Home Edition/ XP Professional/Vista * Only 32-bit is supported.	233 MHz or higher; Intel® Pentium®/Celeron® processor family (500 MHz or higher is recommended)	64 MB or more (256 MB or more is recommended)	at least 128 MB of free space (at least 512 MB of free space is recommended)	800 x 600 HighColor (16-bit)
USB Driver for Windows 2000/XP	Windows 2000/XP Home Edition/XP Professional	166 MHz or higher; Intel® Pentium®/Celeron® processor family	32 MB or more (64 MB or more is recommended)	at least 3 MB of free space	—
USB Driver for Windows Vista/XP x64	Windows Vista/XP Professional x64 Edition	800 MHz or higher; Intel® Pentium® /Celeron® processor family or Intel® 64 compatible processor	512 MB or more	at least 3 MB of free space	—
Digital Music Notebook	Windows XP Home/ Professional Edition, Service Pack 1a (SP1a) more/Windows Vista * Only 32-bit is supported.	400 MHz or higher processor clock speed (Intel® Pentium® / Celeron® Processor family, or compatible processor recommended)	128 MB or more (256 MB or more is recommended)	at least 150 MB of free space	1024 x 768 HighColor (16-bit)
Digital Music Notebook (Requirements for playing content with video included.)	Windows 2000/XP Home Edition/XP Professional/ Vista * Only 32-bit is supported.	1 GHz or higher; Intel® Pentium®/Celeron® Processor family (1.4 GHz or more is recommended)	256 MB or more		

Software Installation

● Uninstall (Removing the Software)

Installed software can be removed from your computer as follows:
From the Windows Start menu select Start → Settings → Control panel → Add or Remove Applications → Install and Uninstall. Select the item you want to remove and click [Add or Remove]. Follow the on-screen instructions to remove the selected software.

NOTE

- The actual names of the menu items and buttons will depend on the OS version you are using.

■ Installing the USB-MIDI Driver...

In order to be able to communicate with and use MIDI devices connected to your computer, the appropriate driver software must be properly installed on your computer.
The USB-MIDI driver allows sequence software and similar applications on your computer to transmit and receive MIDI data to and from MIDI devices via a USB cable.

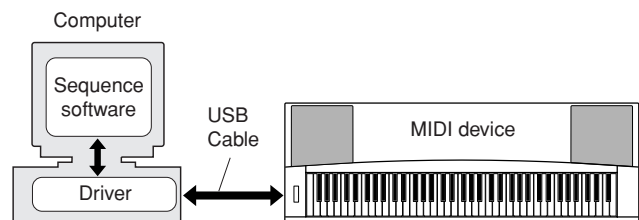

- Windows 2000 installation → page 88.
- Windows XP installation → page 88.
- Windows Vista installation → page 89.

Check the drive name of the CD-ROM drive you will be using (D:, E:, Q: etc.) The drive name is displayed beside the CD-ROM icon in your “My Computer” folder. The root directory of the CD-ROM drive will be D:\, E:\, or Q:\, respectively.

Installing the driver in Windows 2000

- 1** Start the computer and use the “Administrator” account to log on to Windows 2000.
- 2** Select [My Computer] → [Control Panel] → [System] → [Hardware] → [Driver Signing] → [File Signature Verification], and check the radio button to the left of “Ignore—Install all files, regardless of file signature” and click [OK].
- 3** Insert the included CD-ROM into the CD-ROM drive.
A start window will appear automatically.
- 4** First, make sure the POWER switch on the MIDI device is set to OFF, then use a USB cable to connect the MIDI device to the computer. After making the connections, turn on the power of the MIDI device. The system automatically launches the Found New Hardware Wizard. Click [Next]. (Some computers may take a while to display the Wizard window.)
Otherwise, refer to “Troubleshooting” in the “Accessory CD-ROM Installation Guide” section of the Owner’s Manual.
- 5** Select the radio button for “Search for a suitable driver for my device [recommended]”, then click [Next].
- 6** Check the “CD-ROM drives” check box, deselect all other check boxes, then click [Next].

NOTE

• If the system prompts you to insert the Windows CD-ROM during detection of the drivers, point to the “USBdrv2k_” folder (e.g., D:\USBdrv2k_) and continue the installation.

- 7** Deselect the “Install one of the other drivers”, then click [Next].

NOTE

• If the Wizard panel informs you that “The software you are about to install does not contain a Microsoft digital signature”, click [Yes].

- 8** When the installation is complete, the Wizard displays “Completing the Found New Hardware Wizard”.
Click [Finish]. (Some computers may take a while to display the Wizard window.)
- 9** Restart the computer.
The USB-MIDI driver installation is complete.

Installing the driver in Windows XP

- 1** Start the computer and use the “Administrator” account to log on to Windows XP.
- 2** Select [Start] → [Control Panel]. If the control panel appears as “Pick a category”, click “Switch to Classic View” in the upper left of the window.
All control panels and icons will be displayed.
- 3** Go to [System] → [Hardware] → [Driver Signing Options] and check the radio button to the left of “Ignore” and click [OK].
- 4** Click the [OK] button to close System Properties, and then click “X” in the upper right of the window to close the Control Panel.
- 5** Insert the included CD-ROM into the CD-ROM drive.
A start window will appear automatically.
- 6** First, make sure the POWER switch on the MIDI device is set to OFF, then use a USB cable to connect the MIDI device to the computer. After making the connections, turn on the power of the MIDI device. The system launches the Found New Hardware Wizard automatically.
Otherwise, refer to “Troubleshooting” in the “Accessory CD-ROM Installation Guide” section of the Owner’s Manual. If the system displays “Found New Hardware” in the lower right corner, wait until Wizard window is displayed. (Some computers may take a while to display the window.)
If the Wizard window prompts you to specify whether or not to connect to Windows Update, select the radio button for “No, not this time”, then click [Next].

- 7** Select the radio button for “Install the software automatically (recommended)”, then click [Next].

NOTE

• If during the installation the system displays “...has not passed Windows Logo testing to verify its compatibility with Windows XP”, click [Continue Anyway].

- 8** When the installation is complete, the Wizard displays “Completing the Found New Hardware Wizard”.
Click [Finish]. (Some computers may take a while to display the Wizard window.)
- 9** Restart the computer.
If the system displays “Found New Hardware” in the lower right corner, wait until the Wizard window is displayed. (Some computers may take a while to display the Wizard window.)

The USB-MIDI driver installation is complete.

NOTE

- This Wizard window will not appear when using Windows XP Professional x64 Edition. There is no need to restart the computer.

10 When using Windows XP Professional x64 Edition, the Support Module must be installed.

After installing the USB-MIDI drivers for all the connected USB devices, select “My Computer” from the Start menu. Right-click the CD-ROM icon and select “Open” from the pop-up menu. Select “USBdrv Vista_” → “XPx64SupportModule” → “Setup.exe” and launch “Setup.exe.” Follow the on-screen directions.

NOTE

- Once the Support Module is installed, this step is not necessary, even if you’ve connected a new USB device or updated the USB-MIDI driver.

Installing the driver in Windows Vista

- 1** Start the computer and use the “Administrator” account to log on to Windows Vista.
- 2** Insert the included CD-ROM into the CD-ROM drive. A start window will appear automatically.
- 3** First, make sure the POWER switch on the MIDI device is set to OFF, then use a USB cable to connect the MIDI device to the computer. After making the connections, turn on the power of the MIDI device. The system automatically launches the “Found New Hardware” window. Click “Locate and install driver software (recommended)”.

Otherwise, refer to “Troubleshooting” in the “Accessory CD-ROM Installation Guide” section of the Owner’s Manual. (Some computers may take a while to display the window.)

NOTE

- If the “User Account Control” window appears, click [Continue].

- 4** If a message allowing Windows to search online for driver software appears, click “Don’t search online.”
- 5** If a message prompting you to insert the disk that came with your device appears, click [Next].

The system starts the installation.

NOTE

- If the “Windows Security” window appears, confirm this software is authored by Yamaha Corporation then click [Install].

- 6** When the installation is complete, the system displays the message “The software for this device has been successfully installed.” Click [Close].

(Some computers may take a while to display the window.)

The USB-MIDI driver installation is complete.

■ Installing the Musicsoft Downloader and Digital Music Notebook Applications...

IMPORTANT

- You will need to log on with administrator (root) privileges in order to install Musicsoft Downloader on a computer running Windows 2000, XP or Vista.
- You will need to log on with administrator (root) privileges in order to install Digital Music Notebook on a computer running Windows XP or Vista.

IMPORTANT

- When installing the Digital Music Notebook, make sure that Internet Explorer 6.0 (with SP1) or higher is installed to your computer.

IMPORTANT

- Credit card settlement is required to purchase Digital Music Notebook content. Credit card processing may not be possible for some areas, so please check with your local authorities to make sure that your credit card can be used.

NOTE

- Use of the DMN (Digital Music Notebook) is governed by the SIBELIUS SCORCH LICENSE AGREEMENT, which the purchaser fully agrees to when using the application. Please read carefully the AGREEMENT at the end of this manual before using the application.

- 1** Insert the Accessory CD-ROM into your computer’s CD-ROM drive. The start window will appear automatically showing software applications.

NOTE

- If the start window does not appear automatically, double click your “My Computer” folder to open it. Right-click the CD-ROM icon and select “Open” from the pop-up menu. Double click “Start.exe” and proceed to step 2, below.

- 2** Click [Musicsoft Downloader] or [Digital Music Notebook].
- 3** Click the [install] button and follow the on-screen instructions to install the software.

For Digital Music Notebook operating instructions see the help menu: launch the Digital Music Notebook application and click “Help”.

For Musicsoft Downloader operating instructions see the Help menu: launch the Musicsoft Downloader application and click “Help”.

- * You can obtain the latest version of the Musicsoft Downloader at the following Internet URL.

<http://music.yamaha.com/download/>

IMPORTANT

- Only Musicsoft Downloader can be used to transfer files between this instrument and a computer. No other file transfer application can be used.

■ Troubleshooting

The driver cannot be installed.

- **Is the USB cable connected correctly?**
Check the USB cable connection. Disconnect the USB cable, then connect it again.
- **Is the USB function enabled on your computer?**
When you connect the instrument to the computer for the first time, if the “Add New Hardware Wizard” does not appear, the USB function on the computer may be disabled. Perform the following steps.
 - 1** Select [Control Panel]* → [System] → [Hardware] → [Device Manager] (for Windows 2000/XP), or select [Control Panel] → [Device Manager] (for Windows Vista).
* Classic View only in Windows XP.
 - 2** Make sure that no “!” or “x” marks appear at “Universal serial bus controller” or “USB Root Hub”. If you see an “!” or “x” mark, the USB controller is disabled.
- **Is any unknown device registered?**
If driver installation fails, the instrument will be marked as an “Unknown device”, and you will not be able to install the driver. Delete the “Unknown device” by following the steps below.
 - 1** Select [Control Panel]* → [System] → [Hardware] → [Device Manager] (for Windows 2000/XP), or select [Control Panel] → [Device Manager] (for Windows Vista).
* Classic View only in Windows XP.
 - 2** Look for “Other devices” in the menu “View devices by type”.
 - 3** If you find “Other devices”, double-click it to extend the tree to look for “Unknown device”. If one appears, select it and click the [Remove] button.
 - 4** Remove the USB cable from the instrument, and make the connection again.
 - 5** Install the driver again.
 - Windows 2000 users..... see page 88
 - Windows XP users..... see page 88
 - Windows Vista users see page 89

When controlling the instrument from your computer via USB, the instrument does not operate correctly or no sound is heard.

- Did you install the driver? (page 87)
- Is the USB cable connected correctly?

- Are the volume settings of the instrument, playback device, and application program set to the appropriate levels?
- Have you selected an appropriate port in the sequence software?
- Are you using the latest USB-MIDI driver?
The latest driver can be downloaded from the following web site.
<http://music.yamaha.com/download/>

Playback response is delayed.

- Does your computer satisfy the system requirements?
- Is any other application or device driver running?

Cannot suspend or resume the computer correctly.

- Do not suspend the computer while the MIDI application is running.
You may not be able to suspend/resume normally, depending on the particular environment (USB Host Controller, etc.). Even so, simply disconnecting and connecting the USB cable will allow you to use the instrument functions again.

How can I remove the driver?

[Windows 2000/XP/Vista]

- 1** Start the computer and use the “Administrator” account to log on Windows.
Close all applications and windows that are open.
- 2** Insert the included CD-ROM into the CD-ROM drive.
- 3** Select “My Computer” from the Start menu.
- 4** Right-click the CD-ROM icon and select “Open” from the pop-up menu.
- 5** Select “USBdrvVista_” or “USBdrv2k_” folder → “uninstall” folder → “uninstall.exe” file and launch “uninstall.exe.” file.
Follow the on-screen instructions to uninstall the driver.

NOTE

- When using a 64-bit OS, click “uninstall_x64.exe.” from “USBdrvVista_” folder.

NOTE

- If the "User Account Control" window appears, click [Continue].

6 A message asking you to restart your computer in order to complete the uninstall procedure will appear.

Driver removal will be complete when you have restarted your computer.



Troubleshooting

Problem	Possible Cause and Solution
When the instrument is turned on or off, a popping sound is temporarily produced.	This is normal and indicates that the instrument is receiving electrical power.
When using a mobile phone, noise is produced.	Using a mobile phone in close proximity to the instrument may produce interference. To prevent this, turn off the mobile phone or use it further away from the instrument.
There is no sound even when the keyboard is played or when a song or style is being played back.	Check that nothing is connected to the PHONES/OUTPUT jack on the rear panel. When a set of headphones is plugged into this jack, no sound is output. Check the Local Control on/off. (See page 80.)
Playing keys in the right hand area of the keyboard does not produce any sound.	When using the Dictionary function (page 70), the keys in the right hand area are used only for entering the chord root and type.
<ul style="list-style-type: none"> • The volume is too soft. • The sound quality is poor. • The rhythm stops unexpectedly or will not play. • The recorded data of the song, etc. does not play correctly. • The LCD display suddenly goes dark, and all panel settings are reset. 	The batteries are low or dead. Replace all six batteries with completely new ones, or use the optional AC adaptor.
The style or song does not play back when the [START/STOP] button is pressed.	Is External Clock set to ON? Make sure External Clock is set to OFF; refer to "External Clock" on page 80.
The style does not sound properly.	Make sure that the Style Volume (page 76) is set to an appropriate level.
	Is the split point set at an appropriate key for the chords you are playing? Set the split point at an appropriate key (page 65). Is the "ACMP ON" indicator showing in the display? If it is not showing press the [ACMP ON/OFF] button so that it does show.
No rhythm accompaniment plays when the [START/STOP] button is pressed after selecting style number 131 or a style between 143–160 (Pianist).	This is not a malfunction. Style number 131 and style numbers 143–160 (Pianist) have no rhythm parts, so no rhythm will play. The other parts will begin playing when you play a chord in the accompaniment range of the keyboard if style playback is turned on.
Not all of the voices seem to sound, or the sound seems to be cut off.	The instrument is polyphonic up to a maximum of 32 notes. If the Dual voice or Split voice is being used and a style or song is playing back at the same time, some notes/sounds may be omitted (or "stolen") from the accompaniment or song.
The footswitch (for sustain) seems to produce the opposite effect. For example, pressing the footswitch cuts off the sound and releasing it sustains the sounds.	The polarity of the footswitch is reversed. Make sure that the footswitch plug is properly connected to the SUSTAIN jack before turning on the power.
The sound of the voice changes from note to note.	This is normal. The AWM tone generation method uses multiple recordings (samples) of an instrument across the range of the keyboard; thus, the actual sound of the voice may be slightly different from note to note.
The wrong notes sound when the keyboard is played.	Perhaps the performance assistant technology is turned on. Press the [PERFORMANCE ASSISTANT] button to turn it off.
The ACMP ON indicator does not appear when the [ACMP ON/OFF] button is pressed.	Is the [STYLE] button lit? Always press the [STYLE] button first when you are going to use any style-related function.
There is no harmony sound.	The harmony effects (01–26) behave differently according to their type. Types 01–05 function when style playback is on, chords are played in the accompaniment range of the keyboard, and a melody is played in the right-hand range. Types 06–26 will function whether style playback is on or off. For types 06 = 12 you need to play two notes at the same time.



Scores

This demo is an example of how the Easy Song Arranger can be used to change styles throughout a piece.

Song No. 9

♩ = 123

(Function Demo for Easy Song Arranger)

Hallelujah Chorus

Intro **A** D G/D D

Melody

Style Progression

5/23 D G/D D G/D D G/D D A7 D A D/A A

9/27 A D/A A D/A A D/A A D A/C# E7/B A **B** A A/G

13/31 D/F# Bm7 E7sus4 E7 A D/A A D/A A D/A A D/A A

17/35

D D/C G/B Em7 A7sus4 A7 D G/D D G/D D

Main

<Tango> Main

Fill

<Fun 4/4> Main

21/39

G/D D G/D D [C] D 8va G/D D D G/D D

Fill

<Dream Dance> Main

42

G/D D G/D D A7 D D 10

Fill

Ending

This score is provided with the intent that the pitch will be corrected by the performance assistant technology feature. If you play the “Play These Notes” part using the performance assistant technology feature, the part will be corrected and played so that it matches the backing part.

Song No. 10

♩ = 61

(Function Demo for performance assistant technology)

Ave Maria

Melody

Play These Notes

P.A.T. Chord Symbols

These Notes Will Sound

Turn **P.A.T.** ON
Type=CHORD

5

Your Turn.

Repeatedly Play the Same Key.

C + Dm7/C + G7/B + C

Musical score for measures 9-12. The score consists of a vocal line, piano accompaniment, and guitar chord diagrams. The vocal line starts at measure 9 with a melodic phrase. The piano accompaniment is shown in grand staff notation with slash marks indicating rests. The guitar chord diagrams are: Am/C, D7/C, G/B, and CM7/B.

Musical score for measures 13-15. The score consists of a vocal line, piano accompaniment, and guitar chord diagrams. The vocal line starts at measure 13 with a melodic phrase. The piano accompaniment is shown in grand staff notation with slash marks indicating rests. The guitar chord diagrams are: Am7, D7, and G.

This score is provided with the intent that the pitch will be corrected by the performance assistant technology feature. If you play the “Play These Notes” part using the performance assistant technology feature, the part will be corrected and played so that it matches the backing part.

Song No. 11

♩ = 108

(Function Demo for performance assistant technology)

Nocturne op.9-2

Turn **P.A.T.** ON
Type = CHD/FREE
2nd time only

1/5

Play These Notes

P.A.T. Chord Symbols

These Left-hand Notes Will Sound

9/25

You Can Even Play the Same Keys!

F + B^bm/F + F + Am/E + D7

14/30

D7 + Am^b7/G + Gm + C7 + A7/C#

19/35

Dm + Bdim7 + C7sus4 + C7

1. 2.

23

F + F + F + F + F

42

rit.

F + F + F + F + F



Voice List

■ Maximum Polyphony.....

The instrument has 32-note maximum polyphony. This means that it can play a maximum of up to 32 notes at once, regardless of what functions are used. Auto accompaniment uses a number of the available notes, so when auto accompaniment is used the total number of available notes for playing on the keyboard is correspondingly reduced. The same applies to the Split Voice and Song functions. If the maximum polyphony is exceeded, earlier played notes will be cut off and the most recent notes have priority (last note priority).

NOTE

- The Voice List includes MIDI program change numbers for each voice. Use these program change numbers when playing the instrument via MIDI from an external device.
- Program change numbers are often specified as numbers "0-127." Since this list uses a "1-128" numbering system, in such cases it is necessary to subtract 1 from the transmitted program change numbers to select the appropriate sound: e.g. to select No. 2 in the list, transmit program change number 1.
- Some voices may sound continuously or have a long decay after the notes have been released while the sustain pedal (footswitch) is held.

● Panel Voice List

Voice No.	Bank Select		MIDI Program Change# (1-128)	Voice Name
	MSB (0-127)	LSB (0-127)		
PIANO				
001	000	112	001	Grand Piano
002	000	112	002	Bright Piano
003	000	112	007	Harpsichord
004	000	112	004	Honky-tonk Piano
005	000	112	003	MIDI Grand Piano
006	000	113	003	CP 80
E.PIANO				
007	000	114	005	Cool! Galaxy Electric Piano
008	000	113	006	Hyper Tines
009	000	112	005	Funky Electric Piano
010	000	112	006	DX Modern Electric Piano
011	000	114	006	Venus Electric Piano
012	000	112	008	Clavi
ORGAN				
013	000	118	019	Cool! Organ
014	000	117	019	Cool! Rotor Organ
015	000	112	017	Jazz Organ 1
016	000	113	017	Jazz Organ 2
017	000	112	019	Rock Organ
018	000	114	019	Purple Organ
019	000	112	018	Click Organ
020	000	116	017	Bright Organ
021	000	127	019	Theater Organ
022	000	121	020	16'+2' Organ
023	000	120	020	16'+4' Organ
024	000	113	020	Chapel Organ
025	000	112	020	Church Organ
026	000	112	021	Reed Organ
ACCORDION				
027	000	112	022	Musette Accordion
028	000	113	022	Traditional Accordion
029	000	113	024	Bandoneon
030	000	113	023	Modern Harp
031	000	112	023	Harmonica
GUITAR				
032	000	112	025	Classical Guitar
033	000	112	026	Folk Guitar
034	000	112	027	Jazz Guitar
035	000	117	028	60's Clean Guitar
036	000	113	026	12Strings Guitar
037	000	112	028	Clean Guitar
038	000	113	027	Octave Guitar
039	000	112	029	Muted Guitar
040	000	112	030	Overdriven Guitar
041	000	112	031	Distortion Guitar
BASS				
042	000	112	034	Finger Bass
043	000	112	033	Acoustic Bass
044	000	112	035	Pick Bass
045	000	112	036	Fretless Bass
046	000	112	037	Slap Bass
047	000	112	039	Synth Bass
048	000	113	039	Hi-Q Bass
049	000	113	040	Dance Bass

Voice No.	Bank Select		MIDI Program Change# (1-128)	Voice Name
	MSB (0-127)	LSB (0-127)		
STRINGS				
050	000	112	049	String Ensemble
051	000	112	050	Chamber Strings
052	000	113	050	Slow Strings
053	000	112	045	Tremolo Strings
054	000	112	051	Synth Strings
055	000	112	046	Pizzicato Strings
056	000	112	041	Violin
057	000	112	043	Cello
058	000	112	044	Contrabass
059	000	112	047	Harp
060	000	112	106	Banjo
061	000	112	056	Orchestra Hit
CHOIR				
062	000	112	053	Choir
063	000	113	053	Vocal Ensemble
064	000	112	055	Air Choir
065	000	112	054	Vox Humana
SAXOPHONE				
066	000	117	067	Sweet! Tenor Sax
067	000	113	065	Sweet! Soprano Sax
068	000	112	067	Tenor Sax
069	000	112	066	Alto Sax
070	000	112	065	Soprano Sax
071	000	112	068	Baritone Sax
072	000	114	067	Breathy Tenor Sax
073	000	112	072	Clarinet
074	000	112	069	Oboe
075	000	112	070	English Horn
076	000	112	071	Bassoon
TRUMPET				
077	000	115	057	Sweet! Trumpet
078	000	112	057	Trumpet
079	000	112	058	Trombone
080	000	113	058	Trombone Section
081	000	112	060	Muted Trumpet
082	000	112	061	French Horn
083	000	112	059	Tuba
BRASS				
084	000	112	062	Brass Section
085	000	113	062	Big Band Brass
086	000	113	063	80's Brass
087	000	119	062	Mellow Horns
088	000	114	063	Techno Brass
089	000	112	063	Synth Brass
FLUTE				
090	000	114	074	Sweet! Flute
091	000	113	076	Sweet! Pan Flute
092	000	112	074	Flute
093	000	112	073	Piccolo
094	000	112	076	Pan Flute
095	000	112	075	Recorder
096	000	112	080	Ocarina
SYNTH LEAD				
097	000	112	081	Square Lead

Voice No.	Bank Select		MIDI Program Change# (1-128)	Voice Name
	MSB (0-127)	LSB (0-127)		
098	000	112	082	Sawtooth Lead
099	000	115	082	Analogon
100	000	119	082	Fargo
101	000	112	099	Star Dust
102	000	112	086	Voice Lead
103	000	112	101	Brightness
SYNTH PAD				
104	000	112	092	Xenon Pad
105	000	112	095	Equinox
106	000	112	089	Fantasia
107	000	113	090	Dark Moon
108	000	113	101	Bell Pad
PERCUSSION				
109	000	112	012	Vibraphone
110	000	112	013	Marimba
111	000	112	014	Xylophone
112	000	112	115	Steel Drums
113	000	112	009	Celesta
114	000	112	011	Music Box
115	000	112	015	Tubular Bells
116	000	112	048	Timpani
DRUM KITS				
117	127	000	001	Standard Kit 1
118	127	000	002	Standard Kit 2
119	127	000	009	Room Kit
120	127	000	017	Rock Kit
121	127	000	025	Electronic Kit
122	127	000	026	Analog Kit
123	127	000	113	Dance Kit
124	127	000	033	Jazz Kit
125	127	000	041	Brush Kit
126	127	000	049	Symphony Kit
127	126	000	001	SFX Kit 1
128	126	000	002	SFX Kit 2

● XGlite Voice/XGlite Optional Voice* List

Voice No.	Bank Select		MIDI Program Change# (1-128)	Voice Name
	MSB (0-127)	LSB (0-127)		
PIANO				
129	000	000	001	Grand Piano
130	000	001	001	Grand Piano KSP
131	000	040	001	Piano Strings
132	000	041	001	Dream
133	000	000	002	Bright Piano
134	000	001	002	Bright Piano KSP
135	000	000	003	Electric Grand Piano
136	000	001	003	Electric Grand Piano KSP
137	000	032	003	Detuned CP80
138	000	000	004	Honky-tonk Piano
139	000	001	004	Honky-tonk Piano KSP
140	000	000	005	Electric Piano 1
141	000	001	005	Electric Piano 1 KSP
142	000	032	005	Chorus Electric Piano 1
143	000	000	006	Electric Piano 2
144	000	001	006	Electric Piano 2 KSP
*145	000	032	006	Chorus Electric Piano 2
146	000	041	006	DX + Analog Electric Piano
147	000	000	007	Harpsichord
148	000	001	007	Harpsichord KSP
149	000	035	007	Harpsichord 2
150	000	000	008	Clavi
151	000	001	008	Clavi KSP
CHROMATIC				
152	000	000	009	Celesta
153	000	000	010	Glockenspiel
154	000	000	011	Music Box
155	000	064	011	Orgel
156	000	000	012	Vibraphone
157	000	001	012	Vibraphone KSP

Voice No.	Bank Select		MIDI Program Change# (1-128)	Voice Name
	MSB (0-127)	LSB (0-127)		
158	000	000	013	Marimba
159	000	001	013	Marimba KSP
160	000	064	013	Sine Marimba
161	000	097	013	Balimba
162	000	098	013	Log Drums
163	000	000	014	Xylophone
164	000	000	015	Tubular Bells
165	000	096	015	Church Bells
166	000	097	015	Carillon
167	000	000	016	Dulcimer
168	000	035	016	Dulcimer 2
169	000	096	016	Cimbalom
170	000	097	016	Santur
ORGAN				
171	000	000	017	Drawbar Organ
172	000	032	017	Detuned Drawbar Organ
173	000	033	017	60's Drawbar Organ 1
174	000	034	017	60's Drawbar Organ 2
175	000	035	017	70's Drawbar Organ 1
176	000	037	017	60's Drawbar Organ 3
177	000	040	017	16+2'2/3
178	000	064	017	Organ Bass
179	000	065	017	70's Drawbar Organ 2
180	000	066	017	Cheezy Organ
181	000	067	017	Drawbar Organ 2
182	000	000	018	Percussive Organ
183	000	024	018	70's Percussive Organ
184	000	032	018	Detuned Percussive Organ
185	000	033	018	Light Organ
186	000	037	018	Percussive Organ 2
187	000	000	019	Rock Organ
188	000	064	019	Rotary Organ
189	000	065	019	Slow Rotary
190	000	066	019	Fast Rotary
191	000	000	020	Church Organ
192	000	032	020	Church Organ 3
193	000	035	020	Church Organ 2
194	000	040	020	Notre Dame
195	000	064	020	Organ Flute
196	000	065	020	Tremolo Organ Flute
197	000	000	021	Reed Organ
198	000	040	021	Puff Organ
199	000	000	022	Accordion
200	000	000	023	Harmonica
201	000	032	023	Harmonica 2
202	000	000	024	Tango Accordion
203	000	064	024	Tango Accordion 2
GUITAR				
204	000	000	025	Nylon Guitar
205	000	043	025	Velocity Guitar Harmonics
206	000	096	025	Ukulele
207	000	000	026	Steel Guitar
208	000	035	026	12-string Guitar
209	000	040	026	Nylon & Steel Guitar
210	000	041	026	Steel Guitar with Body Sound
211	000	096	026	Mandolin
212	000	000	027	Jazz Guitar
213	000	032	027	Jazz Amp
214	000	000	028	Clean Guitar
215	000	032	028	Chorus Guitar
216	000	000	029	Muted Guitar
217	000	040	029	Funk Guitar
218	000	041	029	Muted Steel Guitar
219	000	045	029	Jazz Man
220	000	000	030	Overdriven Guitar
221	000	043	030	Guitar Pinch
222	000	000	031	Distortion Guitar
223	000	040	031	Feedback Guitar
224	000	041	031	Feedback Guitar 2
225	000	000	032	Guitar Harmonics
226	000	065	032	Guitar Feedback
227	000	066	032	Guitar Harmonics 2

Voice List

Voice No.	Bank Select		MIDI Program Change# (1-128)	Voice Name
	MSB (0-127)	LSB (0-127)		
BASS				
228	000	000	033	Acoustic Bass
229	000	040	033	Jazz Rhythm
230	000	045	033	Velocity Crossfade Upright Bass
231	000	000	034	Finger Bass
232	000	018	034	Finger Dark
233	000	040	034	Bass & Distorted Electric Guitar
234	000	043	034	Finger Slap Bass
235	000	045	034	Finger Bass 2
236	000	065	034	Modulated Bass
237	000	000	035	Pick Bass
238	000	028	035	Muted Pick Bass
239	000	000	036	Fretless Bass
240	000	032	036	Fretless Bass 2
241	000	033	036	Fretless Bass 3
242	000	034	036	Fretless Bass 4
243	000	000	037	Slap Bass 1
244	000	032	037	Punch Thumb Bass
245	000	000	038	Slap Bass 2
246	000	043	038	Velocity Switch Slap
247	000	000	039	Synth Bass 1
248	000	040	039	Techno Synth Bass
249	000	000	040	Synth Bass 2
250	000	006	040	Mellow Synth Bass
251	000	012	040	Sequenced Bass
252	000	018	040	Click Synth Bass
253	000	019	040	Synth Bass 2 Dark
*254	000	040	040	Modular Synth Bass
255	000	041	040	DX Bass
STRINGS				
256	000	000	041	Violin
257	000	008	041	Slow Violin
258	000	000	042	Viola
259	000	000	043	Cello
260	000	000	044	Contrabass
261	000	000	045	Tremolo Strings
262	000	008	045	Slow Tremolo Strings
263	000	040	045	Suspense Strings
264	000	000	046	Pizzicato Strings
265	000	000	047	Orchestral Harp
266	000	040	047	Yang Chin
267	000	000	048	Timpani
ENSEMBLE				
268	000	000	049	Strings 1
269	000	003	049	Stereo Strings
270	000	008	049	Slow Strings
271	000	035	049	60's Strings
272	000	040	049	Orchestra
273	000	041	049	Orchestra 2
274	000	042	049	Tremolo Orchestra
275	000	045	049	Velocity Strings
276	000	000	050	Strings 2
277	000	003	050	Stereo Slow Strings
278	000	008	050	Legato Strings
279	000	040	050	Warm Strings
280	000	041	050	Kingdom
281	000	000	051	Synth Strings 1
282	000	000	052	Synth Strings 2
283	000	000	053	Choir Aahs
284	000	003	053	Stereo Choir
285	000	032	053	Mellow Choir
286	000	040	053	Choir Strings
287	000	000	054	Voice Oohs
288	000	000	055	Synth Voice
289	000	040	055	Synth Voice 2
290	000	041	055	Choral
291	000	064	055	Analog Voice
292	000	000	056	Orchestra Hit
293	000	035	056	Orchestra Hit 2
294	000	064	056	Impact

Voice No.	Bank Select		MIDI Program Change# (1-128)	Voice Name
	MSB (0-127)	LSB (0-127)		
BRASS				
295	000	000	057	Trumpet
296	000	032	057	Warm Trumpet
297	000	000	058	Trombone
298	000	018	058	Trombone 2
299	000	000	059	Tuba
300	000	000	060	Muted Trumpet
301	000	000	061	French Horn
302	000	006	061	French Horn Solo
303	000	032	061	French Horn 2
304	000	037	061	Horn Orchestra
305	000	000	062	Brass Section
306	000	035	062	Trumpet & Trombone Section
307	000	000	063	Synth Brass 1
308	000	020	063	Resonant Synth Brass
309	000	000	064	Synth Brass 2
310	000	018	064	Soft Brass
311	000	041	064	Choir Brass
REED				
312	000	000	065	Soprano Sax
313	000	000	066	Alto Sax
314	000	040	066	Sax Section
315	000	000	067	Tenor Sax
316	000	040	067	Breathy Tenor Sax
317	000	000	068	Baritone Sax
318	000	000	069	Oboe
319	000	000	070	English Horn
320	000	000	071	Bassoon
321	000	000	072	Clarinet
PIPE				
322	000	000	073	Piccolo
323	000	000	074	Flute
324	000	000	075	Recorder
325	000	000	076	Pan Flute
326	000	000	077	Blown Bottle
327	000	000	078	Shakuhachi
328	000	000	079	Whistle
329	000	000	080	Ocarina
SYNTH LEAD				
330	000	000	081	Square Lead
331	000	006	081	Square Lead 2
332	000	008	081	LM Square
333	000	018	081	Hollow
334	000	019	081	Shroud
335	000	064	081	Mellow
336	000	065	081	Solo Sine
337	000	066	081	Sine Lead
338	000	000	082	Sawtooth Lead
339	000	006	082	Sawtooth Lead 2
340	000	008	082	Thick Sawtooth
341	000	018	082	Dynamic Sawtooth
342	000	019	082	Digital Sawtooth
343	000	020	082	Big Lead
344	000	096	082	Sequenced Analog
345	000	000	083	Calliope Lead
346	000	065	083	Pure Lead
347	000	000	084	Chiff Lead
348	000	000	085	Charang Lead
349	000	064	085	Distorted Lead
350	000	000	086	Voice Lead
351	000	000	087	Fifths Lead
352	000	035	087	Big Five
353	000	000	088	Bass & Lead
354	000	016	088	Big & Low
355	000	064	088	Fat & Perky
356	000	065	088	Soft Whirl
SYNTH PAD				
357	000	000	089	New Age Pad
358	000	064	089	Fantasy
359	000	000	090	Warm Pad

Voice No.	Bank Select		MIDI Program Change# (1-128)	Voice Name
	MSB (0-127)	LSB (0-127)		
360	000	000	091	Poly Synth Pad
361	000	000	092	Choir Pad
362	000	066	092	Itopia
363	000	000	093	Bowed Pad
364	000	000	094	Metallic Pad
365	000	000	095	Halo Pad
366	000	000	096	Sweep Pad
SYNTH EFFECTS				
367	000	000	097	Rain
368	000	065	097	African Wind
369	000	066	097	Carib
370	000	000	098	Sound Track
371	000	027	098	Prologue
372	000	000	099	Crystal
373	000	012	099	Synth Drum Comp
374	000	014	099	Popcorn
375	000	018	099	Tiny Bells
376	000	035	099	Round Glockenspiel
377	000	040	099	Glockenspiel Chimes
378	000	041	099	Clear Bells
379	000	042	099	Chorus Bells
380	000	065	099	Soft Crystal
381	000	070	099	Air Bells
382	000	071	099	Bell Harp
383	000	072	099	Gamelimba
384	000	000	100	Atmosphere
385	000	018	100	Warm Atmosphere
386	000	019	100	Hollow Release
387	000	040	100	Nylon Electric Piano
388	000	064	100	Nylon Harp
389	000	065	100	Harp Vox
390	000	066	100	Atmosphere Pad
391	000	000	101	Brightness
392	000	000	102	Goblins
393	000	064	102	Goblins Synth
394	000	065	102	Creeper
395	000	067	102	Ritual
396	000	068	102	To Heaven
397	000	070	102	Night
398	000	071	102	Glister
399	000	096	102	Bell Choir
400	000	000	103	Echoes
401	000	000	104	Sci-Fi
WORLD				
402	000	000	105	Sitar
403	000	032	105	Detuned Sitar
404	000	035	105	Sitar 2
405	000	097	105	Tamboura
406	000	000	106	Banjo
407	000	028	106	Muted Banjo
408	000	096	106	Rabab
409	000	097	106	Gopichant
410	000	098	106	Oud
411	000	000	107	Shamisen
412	000	000	108	Koto
413	000	096	108	Taisho-kin
414	000	097	108	Kanoon
415	000	000	109	Kalimba
416	000	000	110	Bagpipe
417	000	000	111	Fiddle
418	000	000	112	Shanai
PERCUSSIVE				
419	000	000	113	Tinkle Bell
420	000	096	113	Bonang
421	000	097	113	Altair
422	000	098	113	Gamelan Gongs
423	000	099	113	Stereo Gamelan Gongs
424	000	100	113	Rama Cymbal
425	000	000	114	Agogo
426	000	000	115	Steel Drums
427	000	097	115	Glass Percussion

Voice No.	Bank Select		MIDI Program Change# (1-128)	Voice Name
	MSB (0-127)	LSB (0-127)		
428	000	098	115	Thai Bells
429	000	000	116	Woodblock
430	000	096	116	Castanets
431	000	000	117	Taiko Drum
432	000	096	117	Gran Cassa
433	000	000	118	Melodic Tom
434	000	064	118	Melodic Tom 2
435	000	065	118	Real Tom
436	000	066	118	Rock Tom
437	000	000	119	Synth Drum
438	000	064	119	Analog Tom
439	000	065	119	Electronic Percussion
440	000	000	120	Reverse Cymbal
SOUND EFFECTS				
441	000	000	121	Fret Noise
442	000	000	122	Breath Noise
443	000	000	123	Seashore
444	000	000	124	Bird Tweet
445	000	000	125	Telephone Ring
446	000	000	126	Helicopter
447	000	000	127	Applause
448	000	000	128	Gunshot
449	064	000	001	Cutting Noise
450	064	000	002	Cutting Noise 2
451	064	000	004	String Slap
452	064	000	017	Flute Key Click
453	064	000	033	Shower
454	064	000	034	Thunder
455	064	000	035	Wind
456	064	000	036	Stream
457	064	000	037	Bubble
458	064	000	038	Feed
459	064	000	049	Dog
460	064	000	050	Horse
461	064	000	051	Bird Tweet 2
462	064	000	056	Maou
463	064	000	065	Phone Call
464	064	000	066	Door Squeak
465	064	000	067	Door Slam
466	064	000	068	Scratch Cut
467	064	000	069	Scratch Split
468	064	000	070	Wind Chime
469	064	000	071	Telephone Ring 2
470	064	000	081	Car Engine Ignition
471	064	000	082	Car Tires Squeal
472	064	000	083	Car Passing
473	064	000	084	Car Crash
474	064	000	085	Siren
475	064	000	086	Train
476	064	000	087	Jet Plane
477	064	000	088	Starship
478	064	000	089	Burst
479	064	000	090	Roller Coaster
480	064	000	091	Submarine
481	064	000	097	Laugh
482	064	000	098	Scream
483	064	000	099	Punch
484	064	000	100	Heartbeat
485	064	000	101	Footsteps
486	064	000	113	Machine Gun
487	064	000	114	Laser Gun
488	064	000	115	Explosion
489	064	000	116	Firework

The voice number with an asterisk (*) is XGlite optional voice.



Drum Kit List

- “ ” indicates that the drum sound is the same as “Standard Kit 1”.
- Each percussion voice uses one note.
- The MIDI Note # and Note are actually one octave lower than keyboard Note # and Note. For example, in “117: Standard Kit 1”, the “Seq Click H” (Note# 36/Note C1) corresponds to (Note# 24/Note C0).
- Key Off: Keys marked “O” stop sounding the instant they are released.
- Voices with the same Alternate Note Number (*1 ... 4) cannot be played simultaneously. (They are designed to be played alternately with each other.)

	Voice No.						117	118	119	120	121	122
	MSB (0-127) / LSB (0-127) / PC (1-128)						127/000/001	127/000/002	127/000/009	127/000/017	127/000/025	127/000/026
	Keyboard		MIDI		Key Off	Alternate assign	Standard Kit 1	Standard Kit 2	Room Kit	Rock Kit	Electronic Kit	Analog Kit
Note#	Note	Note#	Note	Standard Kit 1			Standard Kit 2	Room Kit	Rock Kit	Electronic Kit	Analog Kit	
	25	C# 0	13	C# -1		3	Surdo Mute					
	26	D 0	14	D -1		3	Surdo Open					
	27	D# 0	15	D# -1			Hi Q					
	28	E 0	16	E -1			Whip Slap					
F0	29	F 0	17	F -1		4	Scratch H					
F#0	30	F# 0	18	F# -1		4	Scratch L					
G0	31	G 0	19	G -1			Finger Snap					
G#0	32	G# 0	20	G# -1			Click Noise					
A0	33	A 0	21	A -1			Metronome Click					
A#0	34	A# 0	22	A# -1			Metronome Bell					
B0	35	B 0	23	B -1			Seq Click L					
C1	36	C 1	24	C 0			Seq Click H					
C#1	37	C# 1	25	C# 0			Brush Tap					
D1	38	D 1	26	D 0 O			Brush Swirl					
D#1	39	D# 1	27	D# 0			Brush Slap					
E1	40	E 1	28	E 0 O			Brush Tap Swirl			Reverse Cymbal	Reverse Cymbal	
F1	41	F 1	29	F 0 O			Snare Roll	Snare Roll 2				
F#1	42	F# 1	30	F# 0			Castanet			Hi Q 2	Hi Q 2	
G1	43	G 1	31	G 0			Snare Soft	Snare Soft 2	Snare Noisy	Snare Snappy Electro	Snare Noisy 4	
G#1	44	G# 1	32	G# 0			Sticks					
A1	45	A 1	33	A 0			Kick Soft		Kick Tight 2	Kick 3	Kick Tight 2	
A#1	46	A# 1	34	A# 0			Open Rim Shot	Open Rim Shot H Short				
B1	47	B 1	35	B 0			Kick Tight	Kick Tight Short	Kick 2	Kick Gate	Kick Analog Short	
C2	48	C 2	36	C 1			Kick	Kick Short	Kick Gate	Kick Gate Heavy	Kick Analog	
C#2	49	C# 2	37	C# 1			Side Stick				Side Stick Analog	
D2	50	D 2	38	D 1			Snare	Snare Short	Snare Snappy	Snare Rock	Snare Noisy 2	
D#2	51	D# 2	39	D# 1			Hand Clap				Snare Analog	
E2	52	E 2	40	E 1			Snare Tight	Snare Tight H	Snare Tight Snappy	Snare Rock Rim	Snare Noisy 3	
F2	53	F 2	41	F 1			Floor Tom L		Tom Room 1	Tom Rock 1	Tom Electro 1	
F#2	54	F# 2	42	F# 1	1		Hi-Hat Closed				Tom Analog 1	
G2	55	G 2	43	G 1			Floor Tom H		Tom Room 2	Tom Rock 2	Tom Electro 2	
G#2	56	G# 2	44	G# 1	1		Hi-Hat Pedal				Tom Analog 2	
A2	57	A 2	45	A 1			Low Tom		Tom Room 3	Tom Rock 3	Tom Electro 3	
A#2	58	A# 2	46	A# 1	1		Hi-Hat Open				Tom Analog 3	
B2	59	B 2	47	B 1			Mid Tom L		Tom Room 4	Tom Rock 4	Tom Electro 4	
C3	60	C 3	48	C 2			Mid Tom H		Tom Room 5	Tom Rock 5	Tom Electro 5	
C#3	61	C# 3	49	C# 2			Crash Cymbal 1				Tom Analog 5	
D3	62	D 3	50	D 2			High Tom		Tom Room 6	Tom Rock 6	Tom Electro 6	
D#3	63	D# 3	51	D# 2			Ride Cymbal 1				Crash Analog	
E3	64	E 3	52	E 2			Chinese Cymbal				Side Stick Analog	
F3	65	F 3	53	F 2			Ride Cymbal Cup				Snare Analog	
F#3	66	F# 3	54	F# 2			Tambourine				Tom Analog 6	
G3	67	G 3	55	G 2			Splash Cymbal				Hi-Hat Closed Analog 2	
G#3	68	G# 3	56	G# 2			Cowbell				Tom Analog 3	
A3	69	A 3	57	A 2			Crash Cymbal 2				Hi-Hat Open Analog	
A#3	70	A# 3	58	A# 2			Vibraslap				Tom Analog 4	
B3	71	B 3	59	B 2			Ride Cymbal 2				Tom Analog 5	
C4	72	C 4	60	C 3			Bongo H				Crash Analog	
C#4	73	C# 4	61	C# 3			Bongo L				Side Stick Analog	
D4	74	D 4	62	D 3			Conga H Mute				Snare Analog	
D#4	75	D# 4	63	D# 3			Conga H Open				Tom Analog 1	
E4	76	E 4	64	E 3			Conga L				Tom Analog 2	
F4	77	F 4	65	F 3			Timbale H				Tom Analog 3	
F#4	78	F# 4	66	F# 3			Timbale L				Tom Analog 4	
G4	79	G 4	67	G 3			Agogo H				Tom Analog 5	
G#4	80	G# 4	68	G# 3			Agogo L				Tom Analog 6	
A4	81	A 4	69	A 3			Cabasa				Crash Analog	
A#4	82	A# 4	70	A# 3			Maracas				Side Stick Analog	
B4	83	B 4	71	B 3 O			Samba Whistle H				Snare Analog	
C5	84	C 5	72	C 4 O			Samba Whistle L				Tom Analog	
D5	85	C# 5	73	C# 4			Guiro Short				Crash Analog	
D#5	86	D 5	74	D 4 O			Guiro Long				Side Stick Analog	
E5	87	D# 5	75	D# 4			Claves				Snare Analog	
F5	88	E 5	76	E 4			Wood Block H				Claves 2	
F#5	89	F 5	77	F 4			Wood Block L				Claves 2	
G5	90	F# 5	78	F# 4			Cuica Mute			Scratch H 2	Scratch H 2	
G#5	91	G 5	79	G 4			Cuica Open			Scratch L 2	Scratch L 3	
A5	92	G# 5	80	G# 4	2		Triangle Mute					
A#5	93	A 5	81	A 4	2		Triangle Open					
B5	94	A# 5	82	A# 4			Shaker					
C6	95	B 5	83	B 4			Jingle Bells					
C#6	96	C 6	84	C 5			Bell Tree					
D6	97	C# 6	85	C# 5								
D#6	98	D 6	86	D 5								
E6	99	D# 6	87	D# 5								
F6	100	E 6	88	E 5								
F#6	101	F 6	89	F 5								
G6	102	F# 6	90	F# 5								
	103	G 6	91	G 5								

	Voice No.						117	123	124	125	126	127	128
	MSB (0-127) / LSB (0-127) / PC (1-128)						127/000/001	127/000/113	127/000/033	127/000/041	127/000/049	126/000/001	126/000/002
	Keyboard			MIDI			Standard Kit 1	Dance Kit	Jazz Kit	Brush Kit	Symphony Kit	SFX Kit 1	SFX Kit 2
	Note#	Note	Note#	Note	Key Off	Alternate assign							
E0		25	C#	0	13	C#	-1						
F0		26	D	0	14	D	-1						
G0	F#0	27	D#	0	15	D#	-1						
A0	G#0	28	E	0	16	E	-1						
B0	A#0	29	F	0	17	F	-1						
C1		30	F#	0	18	F#	-1						
D1	C#1	31	G	0	19	G	-1						
E1	D#1	32	G#	0	20	G#	-1						
F1	F#1	33	A	0	21	A	-1						
G1	G#1	34	A#	0	22	A#	-1						
A1	A#1	35	B	0	23	B	-1						
B1		36	C	1	24	C	0						
C2	C#2	37	C#	1	25	C#	0						
D2	D#2	38	D	1	26	D	0	O					
E2		39	D#	1	27	D#	0						
F2	F#2	40	E	1	28	E	0	O					
G2	G#2	41	F	1	29	F	0	O					
A2	A#2	42	F#	1	30	F#	0						
B2		43	G	1	31	G	0						
C3	C#3	44	G#	1	32	G#	0						
D3	D#3	45	A	1	33	A	0						
E3		46	A#	1	34	A#	0						
F3	F#3	47	B	1	35	B	0						
G3	G#3	48	C	2	36	C	1						
A3	A#3	49	C#	2	37	C#	1						
B3		50	D	2	38	D	1						
C4	C#4	51	D#	2	39	D#	1						
D4	D#4	52	E	2	40	E	1						
E4		53	F	2	41	F	1						
F4	F#4	54	F#	2	42	F#	1						
G4	G#4	55	G	2	43	G	1						
A4	A#4	56	G#	2	44	G#	1						
B4		57	A	2	45	A	1						
C5	C#5	58	A#	2	46	A#	1						
D5	D#5	59	B	2	47	B	1						
E5		60	C	3	48	C	2						
F5	F#5	61	C#	3	49	C#	2						
G5	G#5	62	D	3	50	D	2						
A5	A#5	63	D#	3	51	D#	2						
B5		64	E	3	52	E	2						
C6	C#6	65	F	3	53	F	2						
D6	D#6	66	F#	3	54	F#	2						
E6		67	G	3	55	G	2						
F6	F#6	68	G#	3	56	G#	2						
G6		69	A	3	57	A	2						
		70	A#	3	58	A#	2						
		71	B	3	59	B	2						
		72	C	4	60	C	3						
		73	C#	4	61	C#	3						
		74	D	4	62	D	3						
		75	D#	4	63	D#	3						
		76	E	4	64	E	3						
		77	F	4	65	F	3						
		78	F#	4	66	F#	3						
		79	G	4	67	G	3						
		80	G#	4	68	G#	3						
		81	A	4	69	A	3						
		82	A#	4	70	A#	3						
		83	B	4	71	B	3	O					
		84	C	5	72	C	4	O					
		85	C#	5	73	C#	4						
		86	D	5	74	D	4	O					
		87	D#	5	75	D#	4						
		88	E	5	76	E	4						
		89	F	5	77	F	4						
		90	F#	5	78	F#	4						
		91	G	5	79	G	4						
		92	G#	5	80	G#	4						
		93	A	5	81	A	4						
		94	A#	5	82	A#	4						
		95	B	5	83	B	4						
		96	C	6	84	C	5						
		97	C#	6	85	C#	5						
		98	D	6	86	D	5						
		99	D#	6	87	D#	5						
		100	E	6	88	E	5						
		101	F	6	89	F	5						
		102	F#	6	90	F#	5						
		103	G	6	91	G	5						
											Maou		



Style List

Style No.	Style Name
8BEAT	
1	ChtPnoPp
2	BritRock
3	8BtModrn
4	Cool 8Bt
5	Class8Bt
6	60sGtPop
7	8BtAdria
8	60s8Beat
9	BblgumPp
10	BritPpSw
11	Off Beat
12	60s Rock
13	HardRock
14	RockShfl
15	8Bt Rock
16BEAT	
16	16Beat
17	PnoShfl
18	PopShf 1
19	PopShf 2
20	Gtr Pop
21	16Bt Up
22	KoolShfl
23	JazzRock
24	HH Light
BALLAD	
25	ChtPnoBd
26	GtrBld
27	80sBld
28	PianoBld
29	LoveSong
30	68Modern
31	68SlowRk
32	68OrcBld
33	OrganBld
34	Pop Bld
35	16Bld 1
36	16Bld 2
DANCE	
37	ClubBeat
38	Electron
39	FunkyHse
40	MellowHH
41	EuTrance
42	Ibiza
43	DreamDnc
44	TcnPolis
45	Clubdanc
46	Club Ltn
47	Garage
48	UK Pop
49	HHGroove
50	Hip Shfl
51	HipHopPp
DISCO	
52	70sDsc 1
53	70sDsc 2
54	LatinDsc
55	DscPhily

Style No.	Style Name
56	SatNight
57	DscChoco
58	DscHands
SWING&JAZZ	
59	TradPno1
60	TradPno2
61	PnoBlues
62	BB Fast
63	BBMedium
64	BBBallad
65	BB Shfl
66	JazzClub
67	Swing 1
68	Swing 2
69	OrchSwng
70	FiveFour
71	Jazz Bld
72	Dixie
73	Ragtime
74	AfroCubn
75	Charlstrn
R&B	
76	Soul
77	DetPop 1
78	60s R&R
79	6/8 Soul
80	CroTwist
81	Rck&Roll
82	DetPop 2
83	Boogie 1
84	Boogie 2
85	6/8Blues
COUNTRY	
86	70sCntry
87	Cntry8Bt
88	CntryPop
89	CntrySwg
90	CntryBld
91	Cntry2/4
92	CowboyBg
93	CntryShf
94	Blgrass
LATIN	
95	BrzSamba
96	Bossa
97	PopBossa
98	Tijuana
99	DscLatin
100	Mambo
101	Salsa
102	Beguine
103	GtrRumba
104	Flamenco
105	RmbIslnd
106	Reggae
BALLROOM	
107	VienWltz
108	EngWaltz
109	Slowfox
110	Foxtrot

Style No.	Style Name
111	Quickstp
112	Tango
113	Pasodobl
114	Samba
115	ChaCha
116	Rumba
117	Jive
TRADITIONAL	
118	USMarch
119	6/8March
120	GerMarch
121	PolkaPop
122	OberPlka
123	Trntella
124	Showtune
125	Xmas Swg
126	XmasWltz
127	Reel
128	Hawaiian
WALTZ	
129	ItalyWlz
130	MriacWlz
131	Serenade
132	SwingWlz
133	Jz Wlz 1
134	Jz Wlz 2
135	CntryWlz
136	OberWltz
137	Musette
CHILDREN	
138	Learn2/4
139	Learn4/4
140	Learn6/8
141	Fun 3/4
142	Fun 4/4
PIANIST	
143	Stride
144	PnoBls 1
145	PnoBls 2
146	Pno Rag
147	Pno R&R
148	PnoBoogi
149	PnoJzWlz
150	PnoJzBld
151	Arpeggio
152	Musical
153	Habanera
154	SlowRock
155	8Pno Bld
156	PnoMarch
157	68PnoMrc
158	PnoWaltz
159	PnoBguin
160	PnoSwing



Music Database List

MDB No.	MDB Name	MDB No.	MDB Name	MDB No.	MDB Name	MDB No.	MDB Name	MDB No.	MDB Name
ALL TIME HITS		062	WatchGrl	123	Shouting	COUNTRY		243	Donald's
001	Jude Hey	POP BALLAD		124	Rock&Rll	183	OnTheRd	244	MoonWlz
002	New UK	063	WnderLnd	125	HonkyTnk	184	Breathe	245	MoulinHt
003	MyLoving	064	CanIStop	OLDIES		185	InMyMind	246	Sunshine
004	All OK	065	EvryTime	126	Daydream	186	ContryHw	247	PieceOf
005	Buttercp	066	IvoryAnd	127	Sumertme	187	GreenGrS	248	GreenSlv
006	JustCall	067	TheWorld	128	Diana's	188	EverNeed	249	TakeFour
007	CheepChp	068	LovWoman	129	Uptown	189	Lonesone	250	TexRose
008	Daddy's	069	Dolannes	130	Apache	190	Lucille	251	ThePolka
009	Dance?	070	Madigan	131	IGotIt	191	HomeRng	252	Scarboro
010	GetBack	071	Paradise	132	Tonight	192	Tennesse	253	Edelweis
011	GtrWheel	072	Whisper	133	MyPillow	LATIN		254	AroundWd
012	HighTide	BALLAD		134	NoRain	193	Bananabt	255	Whatever
013	IWasBorn	073	AllOdds	135	FlnalDance	194	DanceMng	256	Yankee's
014	Sailing	074	AtonalFl	136	SlprnLion	195	DntWorry	WORLD	
015	BluJeans	075	Hero	137	Ghetto	196	Jamaica	257	Hawaii
016	Holiday	076	Woman	138	LipsLcky	197	FleaSpa	258	D'amor
017	Imagine	077	RunToYou	139	PrettyWm	198	I'mPola	259	EIcondor
018	LoveMe	078	LoveOfAl	140	TikiGtr	199	MamboJm	260	GoodbyRm
019	LettBlD	079	CndleWnd	141	TurnThre	200	OneNote	261	ILandOn
020	LdyMдона	080	Cavatina	142	Sherry	201	PasoCani	262	ItalyBel
021	YelowSub	081	Cherish	DANCE & DISCO		202	SayNoMor	263	Cucarumb
022	Marriage	082	ToLoveMe	143	Babylon	203	Beguine	264	Puntuali
023	MovinOut	083	YouKnow	144	Goodbye	204	Tijuana	265	Cielito
024	My Shell	084	Evrythng	145	Catch22	205	Picture	266	ItalySun
025	NowNever	085	EyesOfBl	146	DISCO	ENTERTAINMENT		267	SantaLuc
026	DoLoveMe	086	Hello	147	Survival	206	OnTheHil	268	Trumpetr
027	TcktRide	087	BeThere	148	TheNavy	207	Barnacle	269	VanMass
028	SeeClear	088	FlyAway	149	DontHide	208	Califrag	PIANIST	
029	Masachus	089	LoveYou	150	Celebrat	209	DadClock	270	ItalySun
030	Hard Day	090	NeverLet	151	LondonRU	210	DanceLd	271	BeGood
031	USA Pie	091	JustOnce	152	10,2 Sun	211	DnceFire	272	Chaie's
032	Norway	092	IfYouGo	153	ShakeYou	212	BigCntry	273	Flower
033	YesterBd	093	SavingAl	154	Believe	213	Cabaret	274	Frenetic
MODERN POP		094	InTheDrk	155	BoySumer	214	OdeToJoy	275	Highwy66
034	Watches	095	LovePwr	156	I'mSexy	215	Mi-Re-Do	276	Leaves
035	SoundMPH	096	Vision	157	StuffHot	216	MyPrince	277	Miload
036	Hold Us	097	Beautifl	SWING & JAZZ		217	Necessary	278	Cabaret
037	Unfound	098	AllAlone	158	Patrol	218	NoBuiz	279	Wonderfl
038	NeedSome	099	Opposite	159	Charles	219	NoisyOld	280	Submarin
039	PrtTmLvr	100	BeHonest	160	GiveLove	220	Sleigh	281	Mi-Re-Do
040	MoonShdw	101	SayYou	161	Rhythm	221	RockBasy	282	MoreRhum
041	NikitSng	102	SayNthng	162	LOVE	222	Magnifiq	283	NoBuiz
042	Sure of	103	Stranger	163	LeroyBad	223	Magnfcnt	284	BeatifulSn
043	Off Day	104	OneDay	164	Caraban	224	SilentNt	285	OhBlah
044	Tell Her	105	TheBayou	165	Misbehav	225	Nabucco	286	Charades
045	GirlsMne	106	ThisSong	166	Safari	226	Standing	287	Sally's
046	NeedLove	107	Distance	167	Smiling	227	SummerPl	288	Nabucco
POP CLASSICS		108	ThisWay	168	SoWhatIs	228	Christms	289	Spanish
047	Standing	109	LoveGone	169	TimeGone	229	Favorite	290	SunnyStr
048	RainLaff	110	Inspiring	170	TasteHny	230	Tubbie	291	MistyFln
049	Sunshine	111	TrueColr	171	Sandman	231	Turkish	292	LdnBridg
050	ForNamdo	ROCK & ROLL		172	Tunisian	232	12OClock	293	GrndClck
051	ThankFor	112	ShakenUp	173	TwoFoot	WALTZ & TRADITIONAL		294	Importnc
052	ManPiano	113	Beethovn	174	MyBaby	233	Blk&White	295	Snowman
053	CoinLane	114	HurryLov	R&B		234	CanCan	296	Favorite
054	LovesYou	115	BeCruel	175	AsPlayed	235	Charmain	297	SugerSpn
055	Tmbourin	116	Jumping	176	BabyGroV	236	Musicbox	298	Washngtn
056	Alone	117	Countdwn	177	Highwy66	237	Clementn	299	ThisWay
057	GldField	118	SuePeggy	178	SweetCHI	238	Doodah!	300	ZipperD
058	Raindrop	119	Champion	179	JustU&Me	239	Dreamer		
059	SultanSw	120	Jailhous	180	ManLoves	240	EnterRag		
060	Life'sWk	121	BlueShoe	181	OurLove	241	Birthday		
061	TopWorld	122	Rockin24	182	Wish I	242	MaryLamb		



Songs Provided On the Supplied CD-ROM

File Name	Song Name	Composer
001Nutcr.mid	Danse des Mirlitons from "The Nutcracker"	P.I. Tchaikovsky
002Orphe.mid	"Orphée aux Enfers" Overture	J. Offenbach
003Slavo.mid	Slavonic Dances op.72-2	A. Dvořák
004Prima.mid	La Primavera (from Le Quattro Stagioni)	A. Vivaldi
005Medit.mid	Méditation (Thaïs)	J. Massenet
006Guill.mid	Guillaume Tell	G. Rossini
007Fruhl.mid	Frühlingslied	F. Mendelssohn
008Ungar.mid	Ungarische Tänze Nr.5	J. Brahms
009Fruhl.mid	Frühlingsstimmen	J. Strauss II
010Dolly.mid	Dolly's Dreaming and Awakening	T.Oesten
011Cande.mid	La Candeur	J.F.Burgmüller
012Arabe.mid	Arabesque	J.F.Burgmüller
013Pasto.mid	Pastorale	J.F.Burgmüller
014Petit.mid	Petite Réunion	J.F.Burgmüller
015Innoc.mid	Innocence	J.F.Burgmüller
016Progr.mid	Progrès	J.F.Burgmüller
017Taren.mid	Tarentelle	J.F.Burgmüller
018Cheva.mid	La Chevaleresque	J.F.Burgmüller
019Etude.mid	Etude op.10-3 "Chanson de l'adieu"	F.Chopin
020Marci.mid	Marcia alla Turca	L.v. Beethoven
021Turki.mid	Turkish March	W.A. Mozart
022Valse.mid	Valse op.64-1 "Petit Chien"	F.Chopin
023Menue.mid	Menuett	L. Boccherini
024Momen.mid	Moments Musicaux op.94-3	F. Schubert
025Enter.mid	The Entertainer	S. Joplin
026Prelu.mid	Prelude (Wohltemperierte Klavier 1-1)	J.S. Bach
027Violl.mid	La Violette	L. Streabbog
028Angel.mid	Angels Serenade	Traditional
029Saraf.mid	Krasnyj Sarafan	Traditional
030Ameri.mid	America the Beautiful	S.A. Ward
031Brown.mid	Little Brown Jug	Traditional
032Lomon.mid	Loch Lomond	Traditional
033Bonni.mid	My Bonnie	Traditional
034Londo.mid	Londonderry Air	Traditional
035Banjo.mid	Ring de Banjo	S.C. Foster
036Vogle.mid	Wenn ich ein Vöglein wär ?	Traditional
037Lorel.mid	Die Lorelei	F. Silcher
038Funic.mid	Funiculi Funicula	L. Denza
039Turke.mid	Turkey in the Straw	Traditional
040Campt.mid	Campdown Races	S.C. Foster
041Jingl.mid	Jingle Bells	J.S. Pierpont
042Muss.mid	Muss i denn	F. Silcher
043Liebe.mid	Liebesträume Nr.3	F. Liszt
044Jesu.mid	Jesu, Joy Of Man's Desiring	J.S. Bach
045Joy.mid	Ode to Joy	L.v. Beethoven
046Pearl.mid	Pearl Fisher	G. Bizet
047Gavot.mid	Gavotte	F.J. Gossec
048Seren.mid	Serenade/Haydn	F.J. Haydn
049Menue.mid	Menuett BWV. Anh.114	J.S. Bach
050Canon.mid	Canon in D	J. Pachelbel
051Vogel.mid	Der Vogelfänger Bin Ich Ja "Die Zauberflöte"	W.A. Mozart
052Piano.mid	Piano Sonate No.14 op.27-2 "Mondschein"	L.v. Beethoven
053Surpr.mid	The "Surprise" Symphony No.94	F.J. Haydn
054WildR.mid	To a Wild Rose	E.A. MacDowell
055Chans.mid	Chanson du Toreador	G. Bizet
056Babbi.mid	O Mio Babbino Caro	G. Puccini
057RowRo.mid	Row Row Row Your Boat (DUET)	Traditional
058Smoky.mid	On Top of Old Smoky (DUET)	Traditional
059WeWis.mid	We Wish You A Merry Christmas (DUET)	Traditional
060ImMai.mid	Im Mai (DUET)	Traditional
061Chris.mid	O Christmas Tree (DUET)	Traditional
062MaryH.mid	Mary Had a Little Lamb (DUET)	Traditional
063TenLi.mid	Ten Little Indians (DUET)	Septimus Winner
064PopGo.mid	Pop Goes The Weasel (DUET)	Traditional
065Twink.mid	Twinkle Twinkle Little Star (DUET)	Traditional
066Close.mid	Close Your Hands, Open Your Hands (DUET)	J.J. Rousseau
067Cucko.mid	The Cuckoo (DUET)	Traditional
068Augus.mid	O du lieber Augustin (DUET)	Traditional
069Londo.mid	London Bridge (DUET)	Traditional
070Three.mid	Three Blind Mice (DUET)	Traditional

The easy song arranger can only be used with songs that include chord data.



Effect Type List

● Harmony Types

No.	Harmony Type	Description
01	Duet	Harmony types 01–05 are pitch-based and add one-, two- or three-note harmonies to the single-note melody played in the right hand. These types sound when chords are played in the auto accompaniment range of the keyboard. These Harmony types will also work when playing songs that contain chord data.
02	Trio	
03	Block	
04	Country	
05	Octave	
06	Trill 1/4 note	<p>Types 6–26 are rhythm-based effects and add embellishments or delayed repeats in time with the auto accompaniment. These types sound whether the auto accompaniment is on or not; however, the actual speed of the effect depends on the Tempo setting (page 35). The individual note values in each type let you synchronize the effect precisely to the rhythm. Triplet settings are also available: 1/6 = quarter-note triplets, 1/12 = eighth-note triplets, 1/24 = sixteenth-note triplets.</p> <ul style="list-style-type: none"> • The Trill effect Types (06–12) create two-note trills (alternating notes) when two notes are held. • The Tremolo effect Types (13–19) repeat all held notes (up to four). • The Echo effect Types (20–26) create delayed repeats of each note played.
07	Trill 1/6 note	
08	Trill 1/8 note	
09	Trill 1/12 note	
10	Trill 1/16 note	
11	Trill 1/24 note	
12	Trill 1/32 note	
13	Tremolo 1/4 note	
14	Tremolo 1/6 note	
15	Tremolo 1/8 note	
16	Tremolo 1/12 note	
17	Tremolo 1/16 note	
18	Tremolo 1/24 note	
19	Tremolo 1/32 note	
20	Echo 1/4 note	
21	Echo 1/6 note	
22	Echo 1/8 note	
23	Echo 1/12 note	
24	Echo 1/16 note	
25	Echo 1/24 note	
26	Echo 1/32 note	

● Reverb Types

No.	Reverb Type	Description
01–03	Hall 1–3	Concert hall reverb.
04–05	Room 1–2	Small room reverb.
06–07	Stage 1–2	Reverb for solo instruments.
08–09	Plate 1–2	Simulated steel plate reverb.
10	Off	No effect.

● Chorus Types

No.	Chorus Type	Description
01–02	Chorus 1–2	Conventional chorus program with rich, warm chorusing.
03–04	Flanger 1–2	Pronounced three-phase modulation with a slight metallic sound.
05	Off	No effect.



MIDI Implementation Chart

YAMAHA [Portable Grand]
 Model DGX-230/YPG-235

MIDI Implementation Chart

Date: 10-OCT-2007
 Version: 1.0

Function...	Transmitted	Recognized	Remarks
Basic Channel Default Changed	1 - 16 x	1 - 16 x	
Mode Default Messages Altered	3 x *****	3 x x	
Note Number : True voice	0 - 127 *****	0 - 127 0 - 127	
Velocity Note ON Note OFF	0 9nH, v=1-127 x 9nH, v=0	0 9nH, v=1-127 x	
After Touch Key's Ch's	x x	x x	
Pitch Bend	0 0-24 semi	0 0-24 semi	
Control Change	0, 32 1, 11, 84 6, 38 7, 10 64 71 72 73 74 91, 93 96-97 100-101	0 x 0 0 0 x 0 x x 0 x 0	Bank Select Data Entry Sustain Harmonic Content Release Time Attack Time Brightness Effect Depth RPN Inc, Dec RPN LSB, MSB

Prog Change : True #	o 0 - 127 *****	o 0 - 127	
System Exclusive	o	o	
: Song Pos.	x	x	
: Song Sel.	x	x	
: Tune	x	x	
System : Clock	o	o	
Real Time: Commands	o	o	
Aux :All Sound OFF	x	o (120, 126, 127)	
:Reset All Cntrls	x	o (121)	
:Local ON/OFF	x	o (122)	
:All Notes OFF	x	o (123-125)	
Mes- :Active Sense	o	o	
sages:Reset	x	x	

*1 Refer to #2 on page 112.

Mode 1 : OMNI ON , POLY

Mode 3 : OMNI OFF, POLY

Mode 2 : OMNI ON , MONO

Mode 4 : OMNI OFF, MONO

o : Yes

x : No



MIDI Data Format

NOTE:

- 1 By default (factory settings) the instrument ordinarily functions as a 16-channel multi-timbral tone generator, and incoming data does not affect the panel voices or panel settings. However, the MIDI messages listed below do affect the panel voices, auto accompaniment, and songs.
 - MIDI Master Tuning
 - System exclusive messages for changing the Reverb Type and Chorus Type.
- 2 Messages for these control change numbers cannot be transmitted from the instrument itself. However, they may be transmitted when playing the accompaniment, song or using the Harmony effect.
- 3 Exclusive
 - <GM System ON> F0H, 7EH, 7FH, 09H, 01H, F7H
 - This message automatically restores all default settings for the instrument, with the exception of MIDI Master Tuning.
 - <MIDI Master Volume> F0H, 7FH, 7FH, 04H, 01H, II, mm, F7H
 - This message allows the volume of all channels to be changed simultaneously (Universal System Exclusive).
 - The values of "mm" is used for MIDI Master Volume. (Values for "II" are ignored.)

- <MIDI Master Tuning> F0H, 43H, 1nH, 27H, 30H, 00H, 00H, mm, II, cc, F7H
 - This message simultaneously changes the tuning value of all channels.
 - The values of "mm" and "II" are used for MIDI Master Tuning.
 - The default value of "mm" and "II" are 08H and 00H, respectively. Any values can be used for "n" and "cc".
- <Reverb Type> F0H, 43H, 1nH, 4CH, 02H, 01H, 00H, mmH, IIH, F7H
 - mm : Reverb Type MSB
 - II : Reverb Type LSB
 - Refer to the Effect Map (page 112) for details.
- <Chorus Type> F0H, 43H, 1nH, 4CH, 02H, 01H, 20H, mmH, IIH, F7H
 - mm : Chorus Type MSB
 - II : Chorus Type LSB
 - Refer to the Effect Map (page 112) for details.
- 4 When the accompaniment is started, an FAH message is transmitted. When accompaniment is stopped, an FCH message is transmitted. When the clock is set to External, both FAH (accompaniment start) and FCH (accompaniment stop) are recognized.
- 5 Local ON/OFF
 - <Local ON> Bn, 7A, 7F
 - <Local OFF> Bn, 7A, 00
 - Value for "n" is ignored.

■ Effect map

- * When a Type LSB value is received that corresponds to no effect type, a value corresponding to the effect type (coming the closest to the specified value) is automatically set.
- * The numbers in parentheses in front of the Effect Type names correspond to the number indicated in the display.

● REVERB

TYPE MSB	TYPE LSB								
	00	01	02	08	16	17	18	19	20
000	No Effect								
001	(01)Hall1				(02)Hall2	(03)Hall3			
002	Room					(04)Room1		(05)Room2	
003	Stage				(06)Stage1	(07)Stage2			
004	Plate				(08)Plate1	(09)Plate2			
005...127	No Effect								

● CHORUS

TYPE MSB	TYPE LSB								
	00	01	02	08	16	17	18	19	20
000...063	No Effect								
064	Thru								
065	Chorus		(02)Chorus2						
066	Celeste					(01)Chorus1			
067	Flanger			(03)Flanger1		(04)Flanger2			
068...127	No Effect								

ATTENTION

SOFTWARE LICENSE AGREEMENT

PLEASE READ THIS SOFTWARE LICENSE AGREEMENT (“AGREEMENT”) CAREFULLY BEFORE USING THIS SOFTWARE. YOU ARE ONLY PERMITTED TO USE THIS SOFTWARE PURSUANT TO THE TERMS AND CONDITIONS OF THIS AGREEMENT. THIS AGREEMENT IS BETWEEN YOU (AS AN INDIVIDUAL OR LEGAL ENTITY) AND YAMAHA CORPORATION (“YAMAHA”).

BY BREAKING THE SEAL OF THIS PACKAGE YOU ARE AGREEING TO BE BOUND BY THE TERMS OF THIS LICENSE. IF YOU DO NOT AGREE WITH THE TERMS, DO NOT INSTALL, COPY, OR OTHERWISE USE THIS SOFTWARE.

1. GRANT OF LICENSE AND COPYRIGHT

Yamaha hereby grants you the right to use one copy of the software program(s) and data (“SOFTWARE”) accompanying this Agreement. The term SOFTWARE shall encompass any updates to the accompanying software and data. The SOFTWARE is owned by Yamaha and/or Yamaha’s licensor(s), and is protected by relevant copyright laws and all applicable treaty provisions. While you are entitled to claim ownership of the data created with the use of SOFTWARE, the SOFTWARE will continue to be protected under relevant copyrights.

- **You may** use the SOFTWARE on a **single computer**.
- **You may** make one copy of the SOFTWARE in machine-readable form for backup purposes only, if the SOFTWARE is on media where such backup copy is permitted. On the backup copy, you must reproduce Yamaha’s copyright notice and any other proprietary legends that were on the original copy of the SOFTWARE.
- **You may** permanently transfer to a third party all your rights in the SOFTWARE, provided that you do not retain any copies and the recipient reads and agrees to the terms of this Agreement.

2. RESTRICTIONS

- **You may not** engage in reverse engineering, disassembly, decompilation or otherwise deriving a source code form of the SOFTWARE by any method whatsoever.
- **You may not** reproduce, modify, change, rent, lease, or distribute the SOFTWARE in whole or in part, or create derivative works of the SOFTWARE.
- **You may not** electronically transmit the SOFTWARE from one computer to another or share the SOFTWARE in a network with other computers.
- **You may not** use the SOFTWARE to distribute illegal data or data that violates public policy.
- **You may not** initiate services based on the use of the SOFTWARE without permission by Yamaha Corporation.

Copyrighted data, including but not limited to MIDI data for songs, obtained by means of the SOFTWARE, are subject to the following restrictions which you must observe.

- Data received by means of the SOFTWARE may not be used for any commercial purposes without permission of the copyright owner.
- Data received by means of the SOFTWARE may not be duplicated, transferred, or distributed, or played back or performed for listeners in public without permission of the copyright owner.
- The encryption of data received by means of the SOFTWARE may not be removed nor may the electronic watermark be modified without permission of the copyright owner.

3. TERMINATION

This Agreement becomes effective on the day that you receive the SOFTWARE and remains effective until terminated. If any copyright law or provisions of this Agreement is violated, the Agreement shall terminate automatically and immediately without notice from Yamaha. Upon such termination, you must immediately destroy the licensed SOFTWARE, any accompanying written documents and all copies thereof.

4. LIMITED WARRANTY ON MEDIA

As to SOFTWARE sold on tangible media, Yamaha warrants that the tangible media on which the SOFTWARE is recorded will be free from defects in materials and workmanship under normal use for a period of fourteen (14) days from the date of receipt, as evidenced by a copy of the receipt. Yamaha’s entire liability and your exclusive remedy will be replacement of the defective media if it is returned to Yamaha or an authorized Yamaha dealer within fourteen days with a copy of the receipt. Yamaha is not responsible for replacing media damaged by accident, abuse or misapplication. TO THE FULLEST EXTENT PERMITTED BY LAW, YAMAHA EXPRESSLY DISCLAIMS ANY IMPLIED WARRANTIES ON THE TANGIBLE MEDIA, INCLUDING THE IMPLIED WARRANTIES OF MERCHANTABILITY AND FITNESS FOR A PARTICULAR PURPOSE.

5. DISCLAIMER OF WARRANTY ON SOFTWARE

You expressly acknowledge and agree that use of the SOFTWARE is at your sole risk. The SOFTWARE and related documentation are provided “AS IS” and without warranty of any kind. NOTWITHSTANDING ANY OTHER PROVISION OF THIS AGREEMENT, YAMAHA EXPRESSLY DISCLAIMS ALL WARRANTIES AS TO THE SOFTWARE, EXPRESS, AND IMPLIED, INCLUDING BUT NOT LIMITED TO THE IMPLIED WARRANTIES OF MERCHANTABILITY, FITNESS FOR A PARTICULAR PURPOSE AND NON-INFRINGEMENT OF THIRD PARTY RIGHTS. SPECIFICALLY, BUT WITHOUT LIMITING THE FOREGOING, YAMAHA DOES NOT WARRANT THAT THE SOFTWARE WILL MEET YOUR REQUIREMENTS, THAT THE OPERATION OF THE SOFTWARE WILL BE UNINTERRUPTED OR ERROR-FREE, OR THAT DEFECTS IN THE SOFTWARE WILL BE CORRECTED.

6. LIMITATION OF LIABILITY

YAMAHA’S ENTIRE OBLIGATION HEREUNDER SHALL BE TO PERMIT USE OF THE SOFTWARE UNDER THE TERMS HEREOF. IN NO EVENT SHALL YAMAHA BE LIABLE TO YOU OR ANY OTHER PERSON FOR ANY DAMAGES, INCLUDING, WITHOUT LIMITATION, ANY DIRECT, INDIRECT, INCIDENTAL OR CONSEQUENTIAL DAMAGES, EXPENSES, LOST PROFITS, LOST DATA OR OTHER DAMAGES ARISING OUT OF THE USE, MISUSE OR INABILITY TO USE THE SOFTWARE, EVEN IF YAMAHA OR AN AUTHORIZED DEALER HAS BEEN ADVISED OF THE POSSIBILITY OF SUCH DAMAGES. In no event shall Yamaha’s total liability to you for all damages, losses and causes of action (whether in contract, tort or otherwise) exceed the amount paid for the SOFTWARE.

7. THIRD PARTY SOFTWARE

Third party software and data (“THIRD PARTY SOFTWARE”) may be attached to the SOFTWARE. If, in the written materials or the electronic data accompanying the Software, Yamaha identifies any software and data as THIRD PARTY SOFTWARE, you acknowledge and agree that you must abide by the provisions of any Agreement provided with the THIRD PARTY SOFTWARE and that the party providing the THIRD PARTY SOFTWARE is responsible for any warranty or liability related to or arising from the THIRD PARTY SOFTWARE. Yamaha is not responsible in any way for the THIRD PARTY SOFTWARE or your use thereof.

- Yamaha provides no express warranties as to the THIRD PARTY SOFTWARE. IN ADDITION, YAMAHA EXPRESSLY DISCLAIMS ALL IMPLIED WARRANTIES, INCLUDING BUT NOT LIMITED TO THE IMPLIED WARRANTIES OF MERCHANTABILITY AND FITNESS FOR A PARTICULAR PURPOSE, as to the THIRD PARTY SOFTWARE.
- Yamaha shall not provide you with any service or maintenance as to the THIRD PARTY SOFTWARE.
- Yamaha is not liable to you or any other person for any damages, including, without limitation, any direct, indirect, incidental or consequential damages, expenses, lost profits, lost data or other damages arising out of the use, misuse or inability to use the THIRD PARTY SOFTWARE.

8. GENERAL

This Agreement shall be interpreted according to and governed by Japanese law without reference to principles of conflict of laws. Any dispute or procedure shall be heard before the Tokyo District Court in Japan. If for any reason a court of competent jurisdiction finds any portion of this Agreement to be unenforceable, the remainder of this Agreement shall continue in full force and effect.

9. COMPLETE AGREEMENT

This Agreement constitutes the entire agreement between the parties with respect to use of the SOFTWARE and any accompanying written materials and supersedes all prior or contemporaneous understandings or agreements, written or oral, regarding the subject matter of this Agreement. No amendment or revision of this Agreement will be binding unless in writing and signed by a fully authorized representative of Yamaha.

SIBELIUS SCORCH LICENSE AGREEMENT

By installing and/or using this Product you (an individual or legal entity) agree with the Licensor to be bound by the terms of this License which will govern your use of the Product. If you do not accept these terms, do not install or use this Product.

The Product is copyright © 1987-2007 Sibelius Software, a division of Avid Technology, Inc, and its licensors.

1. Definitions

In this License the following words and expressions have the following meanings:

“License”: this agreement between you and the Licensor and, if permitted by the context, the conditional license granted to you in this agreement.

“Licensor”: Avid Technology, Inc., of Avid Technology Park, One Park West, Tewksbury, MA 01876 USA, through its division Sibelius Software, of 20-23 City North, Fonthill Road, London N4 3HF, UK

“Product”: the Software and the Documentation.

“Software”: the Sibelius Scorch web browser plug-in, Opus, Helsinki, Inkpen2 and Reprise font families, any other programs or files supplied by the Licensor which are included in or with the Sibelius Scorch installer, and the Sibelius Scorch installer.

“Documentation”: any documentation in any form relating to the Software supplied to you with the Software or by the Licensor.

2. License

- 2.1 The Licensor grants to you a non-exclusive non-transferable license to use this Software in accordance with the Documentation on any number of computers. Title to the Product is not transferred to you. Ownership of the Product remains vested in the Licensor and its licensors, subject to the rights granted to you under this License. All other rights are reserved.
- 2.2 You may make one printout for your own use of any part of the Documentation provided in electronic form. You shall not make or permit any third party to make any further copies of any part of the Product whether in eye or machine-readable form.
- 2.3 You shall not, and shall not cause or permit any third party to,
 - (1) translate, enhance, modify, alter or adapt the Product or any part of it for any purpose (including without limitation for the purpose of error correction);
 - (2) create derivative works based on the Product, or cause the whole or any part of the Product to be combined with or incorporated into any other program, file or product, for any purpose; or
 - (3) use the Software to create files in any format (other than temporary files created and required by your computer’s operating system or web browser), including without limitation screen capture files, files generated from the Software’s playback, graphics files and print files, for any purpose, except for creating MIDI files (if permitted by the Software) for private non-commercial use.
- 2.4 You shall not, and shall not cause or permit any third party to, decompile, decode, disassemble or reverse engineer the Software in whole or in part for any purpose.
- 2.5 You shall not, and shall not cause any third party to, translate, convert, decode or reverse engineer any file capable of being read by any copy or version of the Software or any data transmitted to or from any copy or version of the Software, in whole or in part for any purpose.
- 2.6 The Product or any part of it must not be used to infringe any right of copyright or right of privacy, publicity or personality or any other right whatsoever of any other person or entity.

3. Copyright

- 3.1 You acknowledge that copyright in the Product as a whole and in the components of the Product as between you and the Licensor belongs to the Licensor or its licensors and is protected by copyright laws, national and international, and all other applicable laws.

4. Disclaimer of Liability

- 4.1 In consideration of the fact that the Product is licensed hereunder free of charge, (a) the Licensor disclaims any and all warranties with respect to the Product, whether expressed or implied, including without limitation any warranties that the Product is free from defects, will perform in accordance with the Documentation, is merchantable, or is fit for any particular purpose, and (b) the Licensor shall not have or incur any liability to you for any loss, cost, expense or claim (including without limitation any liability for loss or corruption of data and loss of profits, revenue or goodwill and any type of special, indirect or consequential loss) that may arise out of or in connection with your installation and use of the Product.

5. Termination

- 5.1 This License shall terminate automatically upon your destruction of the Product. In addition, the Licensor may elect to terminate this License in the event of a material breach by you of any condition of this License or of any of your representations, warranties, covenants or obligations hereunder. Upon notification of such termination by the Licensor, you will immediately delete the Software from your computer and destroy the Documentation.

6. Miscellaneous

- 6.1 No failure to exercise and no delay in exercising on the part of the Licensor of any right, power or privilege arising hereunder shall operate as a waiver thereof, nor shall any single or partial exercise of any right, power or privilege preclude any other or further exercise thereof or the exercise of any other right, power or privilege. The rights and remedies of the Licensor in connection herewith are not exclusive of any rights or remedies provided by law.
- 6.2 You may not distribute, loan, lease, sub-license, rent or otherwise transfer the Product to any third party.
- 6.3 You agree to the use of your personal data in accordance with the Licensor’s privacy policy (available from the Licensor or on www.sibelius.com), which may change from time to time.
- 6.4 This License is intended by the parties hereto to be a final expression of their agreement with respect to the subject matter hereof and a complete and exclusive statement of the terms of such agreement. This License supercedes any and all prior understandings, whether written or oral, between you and the Licensor relating to the subject matter hereof.
- 6.5 (This section only applies if you are resident in the European Union:) This License shall be construed and governed by the laws of England, and both parties agree to submit to the exclusive jurisdiction of the English courts.
- 6.6 (This section only applies if you are not resident in the European Union:) This License shall be construed and enforced in accordance with and governed by the laws of the State of California. Any suit, action or proceeding arising out of or in any way related or connected to this License shall be brought and maintained only in the United States District Court for the Northern District of California, sitting in the City of San Francisco. Each party irrevocably submits to the jurisdiction of such federal court over any such suit, action or proceeding. Each party knowingly, voluntarily and irrevocably waives trial by jury in any suit, action or proceeding (including any counterclaim), whether at law or in equity, arising out of or in any way related or connected to this License or the subject matter hereof.

(License v5.0 (DMN), 30 July 2007)



Specifications

Keyboards

- 76 box type keys (E0–G6), with Touch Response.

Display

- LCD display (backlit)

Setup

- STANDBY/ON
- MASTER VOLUME: MIN–MAX

Panel Controls

- SONG, VOICE, STYLE, EASY SONG ARRANGER, P.A.T. ON/OFF, LESSON L, LESSON R, LESSON START, METRONOME ON/OFF, PORTABLE GRAND, DEMO, FUNCTION, MUSIC DATABASE, HARMONY ON/OFF, DUAL ON/OFF, SPLIT ON/OFF, TEMPO/TAP, [0]–[9], [+], [-], CATEGORY, Dial, REPEAT & LEARN (ACMP ON/OFF), A-B REPEAT (INTRO/ENDING/rit.), PAUSE (SYNC START), START/STOP, REW (MAIN/AUTO FILL), FF (SYNC STOP), REGIST MEMORY ([MEMORY/BANK], [1], [2]), SONG MEMORY (REC, [1]–[5], [A])

Realtime Control

- Pitch Bend Wheel

Voice

- 116 panel voices + 12 drum/SFX kits + 361 XGlite voices
- Polyphony: 32
- DUAL
- SPLIT

Style

- 160 Preset Styles + External files
- Style Control: ACMP ON/OFF, SYNC STOP, SYNC START, START/STOP, INTRO/ENDING/rit., MAIN/AUTO FILL
- Fingering: Multi Finger, Full Keyboard
- Style Volume

Music Database

- 300 + External files

Education Feature

- Dictionary
- Lesson 1–3, Repeat & Learn

Registration Memory

- 8 banks x 2 types

Function

- VOLUME: Style Volume, Song Volume
- OVERALL: Tuning, Transpose, Split Point, Touch Sensitivity, Pitch Bend Range, Chord Fingering
- MAIN VOICE: Volume, Octave, Pan, Reverb Level, Chorus Level
- DUAL VOICE: Voice, Volume, Octave, Pan, Reverb Level, Chorus Level
- SPLIT VOICE: Voice, Volume, Octave, Pan, Reverb Level, Chorus Level
- EFFECT: Reverb Type, Chorus Type, Master EQ Type, Sustain
- HARMONY: Harmony Type, Harmony Volume
- Performance assistant technology: Performance assistant technology Type
- SFF Load: Style File Load
- PC: PC Mode
- MIDI: Local On/Off, External Clock, Initial Send, Keyboard Out, Style Out, Song Out
- METRONOME: Time Signature Numerator, Time Signature Denominator, Metronome Volume
- LESSON: Lesson Track (R), Lesson Track (L), Grade
- UTILITY: Demo Cancel

Effects

- Reverb: 9 types
- Chorus: 4 types
- Harmony: 26 types

Song

- 30 Preset Songs + 5 User Songs + Accessory CD-ROM Songs (70)
- Song Clear, Track Clear
- Song Volume
- Song Control: REPEAT & LEARN, A-B REPEAT, PAUSE, REW, FF, START/STOP

Performance assistant technology

- Chord, Chord/Free

Recording

- Song
 - User Song: 5 Songs
 - Recording Tracks: 1, 2, 3, 4, 5, STYLE

MIDI

- Local On/Off
- Initial Send
- External Clock
- Keyboard Out
- Style Out
- Song Out

Auxiliary jacks

- PHONES/OUTPUT, DC IN 12V, USB, SUSTAIN

Amplifier

- 6W + 6W

Speakers

- 12cm x 2 + 3cm x 2

Power Consumption

- 20W

Power Supply

- Adaptor: PA-150 or an equivalent recommended by Yamaha
- Batteries: Six "D" size, R20P (LR20) or equivalent batteries

Dimensions (W x D x H)

- 1,178 x 412 x 137 mm (46-3/8" x 16-1/4" x 5-3/8")

Weight

- 8.3kg (18 lbs. 5 oz.) (not including batteries)

Supplied Accessories

- Music Rest
- Accessory CD-ROM
- Owner's Manual

Optional Accessories

- AC Power Adaptor: PA-150 or an equivalent recommended by Yamaha
- Footswitch: FC4/FC5
- Keyboard Stand: LW-16
- Headphones: HPE-150

* Specifications and descriptions in this owner's manual are for information purposes only. Yamaha Corp. reserves the right to change or modify products or specifications at any time without prior notice. Since specifications, equipment or options may not be the same in every locale, please check with your Yamaha dealer.



Index

Panel controls and terminals

+/-	13, 51
	50
0-9	13, 51
A-B REPEAT	12, 71
ACMP ON/OFF	12, 20
CATEGORY [] and []	12, 51
DC IN 12V	10, 13
DEMO	13, 26
Dial	12, 51
DUAL ON/OFF	13, 15
EASY SONG ARRANGER	12, 43
FF	12, 26
FUNCTION	12, 75
HARMONY ON/OFF	13, 53
INTRO/ENDING/rit.	12, 63
LESSON L/R	12, 37
LESSON START	12, 37
MAIN/AUTO FILL	12, 63
MASTER VOLUME	12, 50
MEMORY/BANK, 1, 2	13, 73
METRONOME ON/OFF	12, 56
MUSIC DATABASE	12, 42
P.A.T. ON/OFF	12, 29
PAUSE	12, 26
PHONES/OUTPUT	11, 13
PITCH BEND wheel	13, 59
PORTABLE GRAND	13, 17
REC, 1-5, A	12, 45
REGIST. MEMORY	13, 73
REPEAT & LEARN	12, 41
REW	12, 26
SONG	12, 25
SONG MEMORY	12, 45
SPLIT ON/OFF	13, 16
STANDBY/ON	11-12
START/STOP	12, 51
STYLE	12, 19
SUSTAIN	11, 13
SYNC START	12, 63
SYNC STOP	12, 64
TEMPO/TAP	12, 35
USB	13, 79
VOICE	12, 14

Alphabetical order

A	
A-B Repeat	71
Accessories	7
ACMP	20
Auto Accompaniment Range	20
Auto-Accompaniment	20
B	
Backup	49
C	
CD-ROM	85
Channel Message	79
Chord	22-24, 68-69
Chord Dictionary	70
Chord Fingering	66
CHORD ROOT	70
CHORD TYPE	70
Chorus	55
Chorus Type	109
Computer	79
D	
Default Setting	75
Delete (Song Track)	48
Delete (User Song)	48
Demo	26
Demo Cancel	77
Display	52
Drum Kit	18
Drum Kit List	104
Dual Voice	15
Dual Voice Chorus Level	76
Dual Voice Octave	76
Dual Voice Pan	76
Dual Voice Reverb Level	76
Dual Voice Volume	76
E	
Easy Chords	24
Easy Song Arranger	43
Effect Map	112
Effect Type List	109
External Clock	80
External Song	28
F	
Flash Memory	28
Foot Switch	11
Function	75-77
G	
Grade	38
H	
Harmony	53
Harmony Type	53, 109
Harmony Volume	77
Headphones	11
I	
Initial Send	77, 82
Initialization	49
K	
Keyboard Out	80
L	
Lesson	36
Load SFF	67
Local	80
L-Part	84
M	
Main Voice	14
Main Voice Chorus Level	76
Main Voice Octave	76
Main Voice Pan	76
Main Voice Reverb Level	76
Main Voice Volume	76
Master EQ Type	62
Measure	52
Melody Voice	44, 72
Metronome	56
MIDI	78
MIDI Data Format	112
MIDI Implementation Chart	110
Music Database	42
Music Database List	107
Music Rest	7
Mute	72

N	
notation	52
O	
One Touch Setting	61
P	
Panel Sustain	59
PC Mode	81
Performance assistant technology	29
Pitch Bend Range	76
Power Adaptor	10
Preset Song	25, 27–28
R	
Recording	45
Registration Memory	73
Remote control	81
Repeat	41
Reverb	54
Reverb Type	109
R-Part	84
S	
Save (Panel Setting)	73
Score	94–99
SMF (Standard MIDI File)	82
Software Licensing Agreement	113
Song	25
Song Clear	48
Song List	27
Song Memory	45
Song Out	80
Song Volume	71
Specifications	115
Split Point	16, 65
Split Voice	16
Split Voice Chorus Level	76
Split Voice Octave	76
Split Voice Pan	76
Split Voice Reverb Level	76
Split Voice Volume	76
Standard Chords	24
Style	19–23, 63
Style File	67
Style List	106
Style Out	80
Style Volume	65
Sustain (Footswitch)	11
Synchro Start	20, 63
Synchro Stop	64
System Message	79
T	
Tempo	35
Time Signature (Denominator, Numerator)	56
Touch Response	58
Touch Sensitivity	58
Track	45–48
Track Clear	48
Transfer	82–84
Transpose	60
Troubleshooting (Installation)	90
Troubleshooting (instrument)	92
Tuning	60
U	
USB	79
USB-MIDI Driver	88–89
User Song	45
V	
Voice	14
Voice List	100
X	
XGlite	6

Limited Warranty

90 DAYS LABOR

1 YEAR PARTS

Yamaha Corporation of America, hereafter referred to as Yamaha, warrants to the original consumer of a product included in the categories listed below, that the product will be free of defects in materials and/or workmanship for the periods indicated. This warranty is applicable to all models included in the following series of products:

DGX, YPG SERIES OF Portable Grand ELECTRONIC KEYBOARDS

If during the first 90 days that immediately follows the purchase date, your new Yamaha product covered by this warranty is found to have a defect in material and/or workmanship, Yamaha and/or its authorized representative will repair such defect without charge for parts or labor.

If parts should be required after this 90 day period but within the one year period that immediately follows the purchase date, Yamaha will, subject to the terms of this warranty, supply these parts without charge. However, charges for labor, and/or any miscellaneous expenses incurred are the consumers responsibility. Yamaha reserves the right to utilize reconditioned parts in repairing these products and/or to use reconditioned units as warranty replacements.

THIS WARRANTY IS THE ONLY EXPRESS WARRANTY WHICH YAMAHA MAKES IN CONNECTION WITH THESE PRODUCTS. ANY IMPLIED WARRANTY APPLICABLE TO THE PRODUCT, INCLUDING THE WARRANTY OF MERCHANT ABILITY IS LIMITED TO THE DURATION OF THE EXPRESS WARRANTY. YAMAHA EXCLUDES AND SHALL NOT BE LIABLE IN ANY EVENT FOR INCIDENTAL OR CONSEQUENTIAL DAMAGES.

Some states do not allow limitations that relate to implied warranties and/or the exclusion of incidental or consequential damages. Therefore, these limitations and exclusions may not apply to you.

This warranty gives you specific legal rights. You may also have other rights which vary from state to state.

CONSUMERS RESPONSIBILITIES

If warranty service should be required, it is necessary that the consumer assume certain responsibilities:

1. Contact the Customer Service Department of the retailer selling the product, or any retail outlet authorized by Yamaha to sell the product for assistance. You may also contact Yamaha directly at the address provided below.
2. Deliver the unit to be serviced under warranty to: the retailer selling the product, an authorized service center, or to Yamaha with an explanation of the problem. Please be prepared to provide proof purchase date (sales receipt, credit card copy, etc.) when requesting service and/or parts under warranty.
3. Shipping and/or insurance costs are the consumers responsibility.* Units shipped for service should be packed securely.

*Repaired units will be returned PREPAID if warranty service is required within the first 90 days.

IMPORTANT: Do NOT ship anything to ANY location without prior authorization. A Return Authorization (RA) will be issued that has a tracking number assigned that will expedite the servicing of your unit and provide a tracking system if needed.

4. Your owners manual contains important safety and operating instructions. It is your responsibility to be aware of the contents of this manual and to follow all safety precautions.

EXCLUSIONS

This warranty does not apply to units whose trade name, trademark, and/or ID numbers have been altered, defaced, exchanged removed, or to failures and/or damages that may occur as a result of:

1. Neglect, abuse, abnormal strain, modification or exposure to extremes in temperature or humidity.
2. Improper repair or maintenance by any person who is not a service representative of a retail outlet authorized by Yamaha to sell the product, an authorized service center, or an authorized service representative of Yamaha.
3. This warranty is applicable only to units sold by retailers authorized by Yamaha to sell these products in the U.S.A., the District of Columbia, and Puerto Rico. This warranty is not applicable in other possessions or territories of the U.S.A. or in any other country.

Please record the model and serial number of the product you have purchased in the spaces provided below.

Model _____ Serial # _____ Sales Slip # _____

Purchased from _____ Date _____
(Retailer)

YAMAHA CORPORATION OF AMERICA
Electronic Service Division
6600 Orangethorpe Avenue
Buena Park, CA 90620

KEEP THIS DOCUMENT FOR YOUR RECORDS. DO NOT MAIL!

For details of products, please contact your nearest Yamaha representative or the authorized distributor listed below.

Pour plus de détails sur les produits, veuillez-vous adresser à Yamaha ou au distributeur le plus proche de vous figurant dans la liste suivante.

Die Einzelheiten zu Produkten sind bei Ihrer unten aufgeführten Niederlassung und bei Yamaha Vertragshändlern in den jeweiligen Bestimmungsländern erhältlich.

Para detalles sobre productos, contacte su tienda Yamaha más cercana o el distribuidor autorizado que se lista debajo.

NORTH AMERICA

CANADA

Yamaha Canada Music Ltd.
135 Milner Avenue, Scarborough, Ontario,
M1S 3R1, Canada
Tel: 416-298-1311

U.S.A.

Yamaha Corporation of America
6600 Orangethorpe Ave., Buena Park, Calif. 90620,
U.S.A.
Tel: 714-522-9011

CENTRAL & SOUTH AMERICA

MEXICO

Yamaha de México S.A. de C.V.
Calz. Javier Rojo Gómez #1149,
Col. Guadalupe del Moral
C.P. 09300, México, D.F., México
Tel: 55-5804-0600

BRAZIL

Yamaha Musical do Brasil Ltda.
Rua Joaquim Floriano, 913 - 4º andar, Itaim Bibi,
CEP 04534-013 Sao Paulo, SP. BRAZIL
Tel: 011-3704-1377

ARGENTINA

Yamaha Music Latin America, S.A.
Sucursal de Argentina
Viamonte 1145 Piso 2-B 1053,
Buenos Aires, Argentina
Tel: 1-4371-7021

PANAMA AND OTHER LATIN AMERICAN COUNTRIES/ CARIBBEAN COUNTRIES

Yamaha Music Latin America, S.A.
Torre Banco General, Piso 7, Urbanización Marbella,
Calle 47 y Aquilino de la Guardia,
Ciudad de Panamá, Panamá
Tel: +507-269-5311

EUROPE

THE UNITED KINGDOM

Yamaha Music U.K. Ltd.
Sherbourne Drive, Tilbrook, Milton Keynes,
MK7 8BL, England
Tel: 01908-366700

IRELAND

Danfay Ltd.
61D, Sallynoggin Road, Dun Laoghaire, Co. Dublin
Tel: 01-2859177

GERMANY

Yamaha Music Central Europe GmbH
Siemensstraße 22-34, 25462 Rellingen, Germany
Tel: 04101-3030

SWITZERLAND/LIECHTENSTEIN

Yamaha Music Central Europe GmbH,
Branch Switzerland
Seefeldstrasse 94, 8008 Zürich, Switzerland
Tel: 01-383 3990

AUSTRIA

Yamaha Music Central Europe GmbH,
Branch Austria
Schleiergasse 20, A-1100 Wien, Austria
Tel: 01-60203900

CZECH REPUBLIC/SLOVAKIA/ HUNGARY/SLOVENIA

Yamaha Music Central Europe GmbH,
Branch Austria, CEE Department
Schleiergasse 20, A-1100 Wien, Austria
Tel: 01-602039025

POLAND

Yamaha Music Central Europe GmbH
Sp.z o.o. Oddział w Polsce
ul. 17 Stycznia 56, PL-02-146 Warszawa, Poland
Tel: 022-868-07-57

THE NETHERLANDS/ BELGIUM/LUXEMBOURG

Yamaha Music Central Europe GmbH,
Branch Benelux
Clarissenhof 5-b, 4133 AB Vianen, The Netherlands
Tel: 0347-358 040

FRANCE

Yamaha Musique France
BP 70-77312 Marne-la-Vallée Cedex 2, France
Tel: 01-64-61-4000

ITALY

Yamaha Musica Italia S.P.A.
Viale Italia 88, 20020 Lainate (Milano), Italy
Tel: 02-935-771

SPAIN/PORTUGAL

Yamaha Música Ibérica, S.A.
Ctra. de la Corona km. 17, 200, 28230
Las Rozas (Madrid), Spain
Tel: 91-639-8888

GREECE

Philippos Nakas S.A. The Music House
147 Skiathou Street, 112-55 Athens, Greece
Tel: 01-228 2160

SWEDEN

Yamaha Scandinavia AB
J. A. Wettergrens Gata 1, Box 30053
S-400 43 Göteborg, Sweden
Tel: 031 89 34 00

DENMARK

YS Copenhagen Liaison Office
Generatorvej 6A, DK-2730 Herlev, Denmark
Tel: 44 92 49 00

FINLAND

F-Musiikki Oy
Kluuvikatu 6, P.O. Box 260,
SF-00101 Helsinki, Finland
Tel: 09 618511

NORWAY

Norsk filial av Yamaha Scandinavia AB
Grini Næringspark 1, N-1345 Østerås, Norway
Tel: 67 16 77 70

ICELAND

Skifan HF
Skeifan 17 P.O. Box 8120, IS-128 Reykjavik, Iceland
Tel: 525 5000

RUSSIA

Yamaha Music (Russia)
Office 4015, entrance 2, 21/5 Kuznetskii
Most street, Moscow, 107996, Russia
Tel: 495 626 0660

OTHER EUROPEAN COUNTRIES

Yamaha Music Central Europe GmbH
Siemensstraße 22-34, 25462 Rellingen, Germany
Tel: +49-4101-3030

AFRICA

Yamaha Corporation,
Asia-Pacific Music Marketing Group
Nakazawa-cho 10-1, Naka-ku, Hamamatsu,
Japan 430-8650
Tel: +81-53-460-2312

MIDDLE EAST

TURKEY/CYPRUS

Yamaha Music Central Europe GmbH
Siemensstraße 22-34, 25462 Rellingen, Germany
Tel: 04101-3030

OTHER COUNTRIES

Yamaha Music Gulf FZE
LOB 16-513, P.O.Box 17328, Jubel Ali,
Dubai, United Arab Emirates
Tel: +971-4-881-5868

ASIA

THE PEOPLE'S REPUBLIC OF CHINA

Yamaha Music & Electronics (China) Co.,Ltd.
25/F., United Plaza, 1468 Nanjing Road (West),
Jingan, Shanghai, China
Tel: 021-6247-2211

HONG KONG

Tom Lee Music Co., Ltd.
11/F., Silvercord Tower 1, 30 Canton Road,
Tsimshatsui, Kowloon, Hong Kong
Tel: 2737-7688

INDONESIA

PT. Yamaha Music Indonesia (Distributor)
PT. Nusantik
Gedung Yamaha Music Center, Jalan Jend. Gatot
Subroto Kav. 4, Jakarta 12930, Indonesia
Tel: 21-520-2577

KOREA

Yamaha Music Korea Ltd.
8F, 9F, Dongsung Bldg. 158-9 Samsung-Dong,
Kangnam-Gu, Seoul, Korea
Tel: 080-004-0022

MALAYSIA

Yamaha Music Malaysia, Sdn., Bhd.
Lot 8, Jalan Perbandaran, 47301 Kelana Jaya,
Petaling Jaya, Selangor, Malaysia
Tel: 3-78030900

PHILIPPINES

Yupangco Music Corporation
339 Gil J. Puyat Avenue, P.O. Box 885 MCPO,
Makati, Metro Manila, Philippines
Tel: 819-7551

SINGAPORE

Yamaha Music Asia Pte., Ltd.
#03-11 A-Z Building
140 Paya Lebar Road, Singapore 409015
Tel: 747-4374

TAIWAN

Yamaha KHS Music Co., Ltd.
3F, #6, Sec.2, Nan Jing E. Rd. Taipei.
Taiwan 104, R.O.C.
Tel: 02-2511-8688

THAILAND

Siam Music Yamaha Co., Ltd.
891/1 Siam Motors Building, 15-16 floor
Rama 1 road, Wangmai, Pathumwan
Bangkok 10330, Thailand
Tel: 02-215-2626

OTHER ASIAN COUNTRIES

Yamaha Corporation,
Asia-Pacific Music Marketing Group
Nakazawa-cho 10-1, Naka-ku, Hamamatsu,
Japan 430-8650
Tel: +81-53-460-2317

OCEANIA

AUSTRALIA

Yamaha Music Australia Pty. Ltd.
Level 1, 99 Queensbridge Street, Southbank,
Victoria 3006, Australia
Tel: 3-9693-5111

NEW ZEALAND

Music Houses of N.Z. Ltd.
146/148 Captain Springs Road, Te Papapa,
Auckland, New Zealand
Tel: 9-634-0099

COUNTRIES AND TRUST TERRITORIES IN PACIFIC OCEAN

Yamaha Corporation,
Asia-Pacific Music Marketing Group
Nakazawa-cho 10-1, Naka-ku, Hamamatsu,
Japan 430-8650
Tel: +81-53-460-2312

HEAD OFFICE Yamaha Corporation, Pro Audio & Digital Musical Instrument Division
Nakazawa-cho 10-1, Naka-ku, Hamamatsu, Japan 430-8650
Tel: +81-53-460-3273



Yamaha Home Keyboards Home Page (English Only)
<http://music.yamaha.com/homekeyboard>

Yamaha Manual Library
<http://www.yamaha.co.jp/manual/>

U.R.G., Pro Audio & Digital Musical Instrument Division, Yamaha Corporation
© 2007 Yamaha Corporation

WM36950 XXXPOXXX.X-01A0
Printed in China