

Clavinova®

CVP-809

CVP-805

Reference Manual

This manual explains the functions called up by touching each icon shown in the Menu display. Please read the Owner's Manual first for basic operations, before reading this Reference Manual.

Using the PDF manual































- To quickly jump to items and topics of interest, click on the desired items in the “Bookmarks” index to the left of the computer display window. (Click the “Bookmarks” tab to open the index if it is not displayed.)
- Click the page numbers that appear in this manual to go directly to the corresponding page.
- Select “Find” or “Advanced Search” from the Adobe Reader “Edit” menu and enter a keyword to locate related information anywhere in the document.

NOTE The names and positions of menu items may vary according to the version of Adobe Reader being used.

- The illustrations and displays as shown in this manual are based on the CVP-809 (in English). These are for instructional purposes only, and may appear somewhat different from those on your instrument.
- The explanations in this manual apply to the firmware version 1.00. Yamaha may from time to time update firmware of the product without notice for improvement. We recommend that you check our website for later releases and upgrade your firmware.
<https://download.yamaha.com/>
- The company names and product names in this manual are the trademarks or registered trademarks of their respective companies.

Contents

Each chapter in this Reference Manual corresponds to each icons on the Menu display.

 100 Tempo	Adjusting the Tempo 4	 Assignable	Assigning a Specific Function to Each Pedal or ASSIGNABLE button 43
 Transpose	Transposing the Pitch in Semitones 5	 VoiceEdit	Editing a Voice (Voice Edit)47
 Split&Fingering	Changing the Split Point, Fingering Type or Chord Detection Area 6	 VoiceEdit	Editing an Organ Flutes Voice (Voice Edit)51
 ChordTutor	Learning How To Play Specific Chords (Chord Tutor) 8	 StyleCreator	Creating/Editing Styles (Style Creator) 53
 Balance	Adjusting the Volume Balance 9	 SongCreator	Creating/Editing MIDI Songs (Song Creator)66
 Mixer	Editing the Volume and Tonal Balance (Mixer) 10	 VoiceSetting	Voice Settings78
 Score	Editing Music Notation (Score) Settings 18	 StyleSetting	Style Playback Related Settings84
 Lyrics	Editing Lyrics Display Settings 20	 SongSetting	Song Settings Related to Playback/Recording87
 TextViewer	Showing the Text Display and Editing Text Display Settings 22	 Tuning	Fine Tuning the Pitch92
 KbdHarmony	Using Keyboard Harmony 24	 Keyboard	Setting the Touch Sensitivity of the Keyboard94
 MicSetting	Microphone Settings 26	 Metronome	Metronome Settings95
 VocalHarmony	Vocal Harmony Settings 28	 MIDI	MIDI Settings96
 Playlist	Using Playlist 33	 Utility	Making Global Settings (Utility) 102
 RegistSeq	Calling Up Registration Memory Numbers in Order (Registration Sequence) 35	 Bluetooth	Connecting to a Bluetooth-equipped Device107
 RegistFreeze	Disabling Recall of Specific Items (Registration Freeze) 37	 WirelessLAN	Wireless LAN Settings108
 ChordLooper	Playing Styles Automatically with Your Custom Chord Progressions (Chord Looper) 38	 14:38 Time	Making the Time Settings110
			Index 111

NOTE The “Bluetooth” icon is shown only if the instrument is equipped with Bluetooth functionality. Depending on the country in which you purchased it, Bluetooth may not be available.

NOTE The “WirelessLAN” and “Time” icons are shown only when the USB Wireless LAN adaptor (UD-WL01) is connected to the [USB TO DEVICE] terminal.

Calling up Desired Functions from the Home Display

From all the functions shown on the Menu display, you can pick out an often used one and register it to a shortcut and place it in the Menu area at the bottom of the Home display. Although seven shortcuts are registered by default, you can customize them as necessary.

- 1 Touch and hold the icon of the desired function until the color of the shortcut area (bottom of the display) changes.**

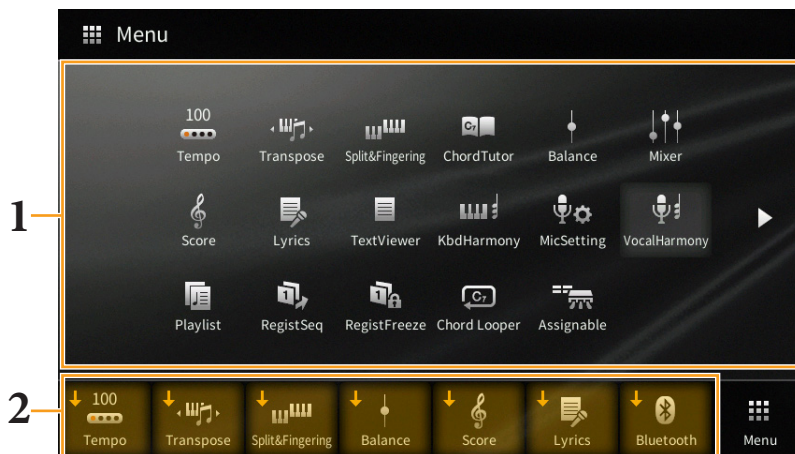

NOTE To cancel this operation, touch any blank location on the display before going on to step 2.

- 2 From the seven locations at the bottom of the display, touch the one you want to replace.**
The function selected in step 1 will be registered, replacing the one selected here.

To delete or move a shortcut, touch and hold the desired shortcut icon on the Home display or the Menu display until the color changes. Then, touch the same icon again to delete it or touch the desired destination icon to move the shortcut.

Adjusting the Tempo

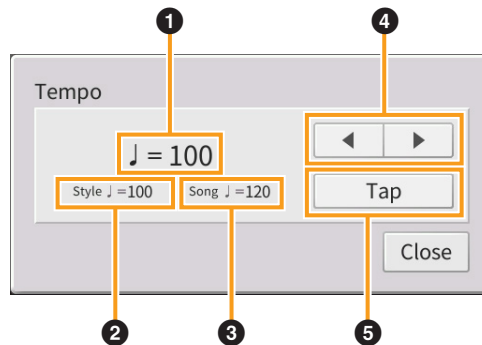

❶	Indicates the tempo value during playback of the metronome, Style and MIDI Song.
❷	Indicates the tempo value of the current Style. The Style will be started at this tempo.
❸	Indicates the tempo value of the current MIDI Song. The Song will be started at this tempo.
❹	These are basically equivalent to the TEMPO [-]/[+] buttons on the panel. If you want to call up the default tempo of the current Style and MIDI Song, touch and hold any area in ❶ – ❸.
❺	Equivalent to the [TAP TEMPO] button on the panel.

NOTE The tempo value of an Audio Song is set via the Time Stretch function. Refer to the Owner's Manual, Chapter 5.

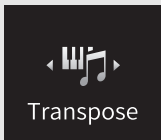

Transposing the Pitch in Semitones

You can transpose the overall pitch of the instrument (the keyboard sound, Style playback, MIDI Song playback, and so on) in semitone steps.

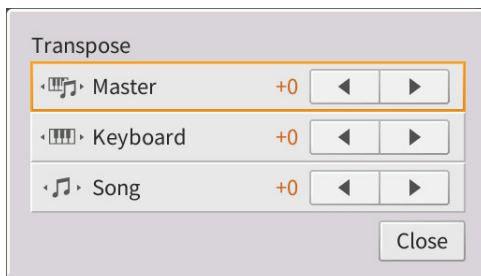

Master	Transposes the overall pitch of the instrument, except for the Audio Songs, sound input to the [MIC/LINE IN] jack, and the Audio input from an external device by using such as [AUX IN] jack.
Keyboard	Transposes the pitch of keyboard including Style playback (controlled via the chord section of the keyboard).
Song	Transposes only the pitch of MIDI Song playback.

NOTE The pitch of an Audio Song is adjusted via the Pitch Shift function. Refer to the Owner's Manual, Chapter 5.

NOTE Transpose is not applied to the Drum Kits and SFX Kits Voice.

NOTE Transpose can also be done by using the TRANSPOSE buttons on the control panel. By touching the Transpose pop-up several times, you can select the part to be transpose as desired.

Split Point/Fingering Type

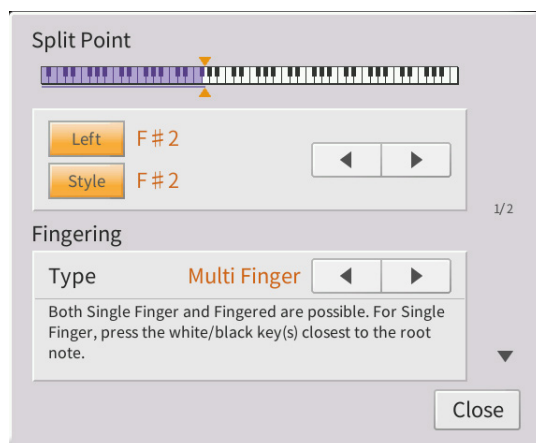

For information about Split Point, refer to the Owner’s Manual, Chapter 3. For information about Fingering Types, refer to the Owner’s Manual, Chapter 4.

Chord Types Recognized in the Fingered Mode

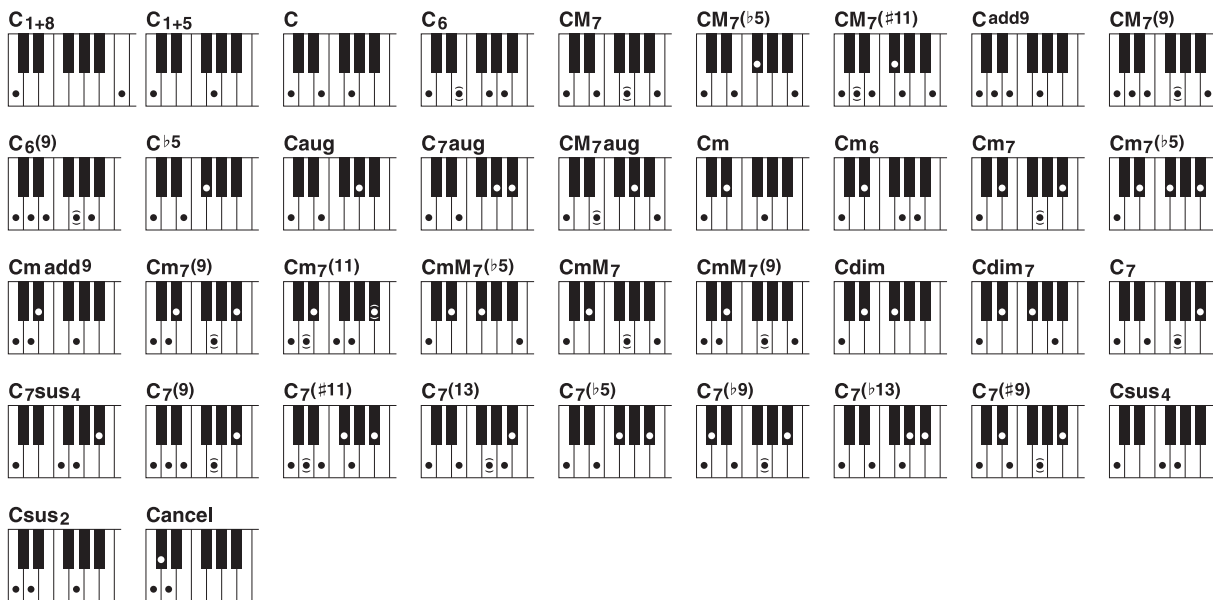

Chord Name [Abbreviation]	Normal Voicing	Display for root “C”
1+8	1+8	C1+8
1+5	1+5	C1+5
Major [M]	1+3+5	C
Sixth [6]	1+(3)+5+6	C6
Major seventh [M7]	1+3+(5)+7	CM7
Major seventh flatted fifth [M7 b 5]	1+3+ b 5+7	CM7(b 5)
Major seventh add sharp eleventh [M7(# 11)]	1+(2)+3+ # 4+5+7	CM7(# 11)
Add ninth [(add9)]	1+2+3+5	Cadd9
Major seventh ninth [M7_9]	1+2+3+(5)+7	CM7(9)
Sixth ninth [6_9]	1+2+3+(5)+6	C6(9)
Flatted fifth [(b 5)]	1+3+ b 5	C b 5

Chord Name [Abbreviation]	Normal Voicing	Display for root "C"
Augmented [aug]	1+3+ #5	Caug
Seventh augmented [7aug]	1+3+ #5+ b7	C7aug
Major seventh augmented [M7aug]	1+(3)+ #5+7	CM7aug
Minor [m]	1+ b3+5	Cm
Minor sixth [m6]	1+ b3+5+6	Cm6
Minor seventh [m7]	1+ b3+(5)+ b7	Cm7
Minor seventh flatted fifth [m7 b5]	1+ b3+ b5+ b7	Cm7(b5)
Minor add ninth [m(add9)]	1+2+ b3+5	Cm add9
Minor seventh ninth [m7(9)]	1+2+ b3+(5)+ b7	Cm7(9)
Minor seventh eleventh [m7(11)]	1+(2)+ b3+4+5+(b7)	Cm7(11)
Minor major seventh flatted fifth [mM7 b5]	1+ b3+ b5+7	CmM7(b5)
Minor major seventh [mM7]	1+ b3+(5)+7	CmM7
Minor major seventh ninth [mM7(9)]	1+2+ b3+(5)+7	CmM7(9)
Diminished [dim]	1+ b3+ b5	Cdim
Diminished seventh [dim7]	1+ b3+ b5+6	Cdim7
Seventh [7]	1+3+(5)+ b7	C7
Seventh suspended fourth [7sus4]	1+4+5+ b7	C7sus4
Seventh ninth [7(9)]	1+2+3+(5)+ b7	C7(9)
Seventh add sharp eleventh [7(#11)]	1+(2)+3+ #4+5+ b7	C7(#11)
Seventh add thirteenth [7(13)]	1+3+(5)+6+ b7	C7(13)
Seventh flatted fifth [7 b5]	1+3+ b5+ b7	C7(b5)
Seventh flatted ninth [7(b9)]	1+ b2+3+(5)+ b7	C7(b9)
Seventh add flatted thirteenth [7(b13)]	1+3+5+ b6+ b7	C7(b13)
Seventh sharp ninth [7(#9)]	1+ #2+3+(5)+ b7	C7(#9)
Suspended fourth [sus4]	1+4+5	Csus4
One plus two plus five [sus2]	1+2+5	Csus2
cancel	1+ b2+2	Cancel

NOTE Notes in parentheses can be omitted.

NOTE The "cancel" indication refers to Chord Cancel, which stops the last selected chord from playing and leaves only the drums/ rhythm.

Specifying Chords with Your Right Hand for Style Playback

By changing the Chord Detection area from the left-hand section to the right-hand section, you can play a bass line with your left hand while using your right hand to play chords for controlling Style playback.

- 1** Call up page 2/2 of the Split Point/Fingering window.
- 2** Make the necessary settings by touching the display.

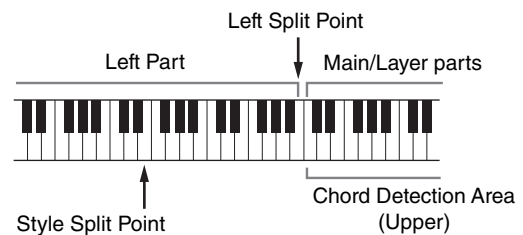
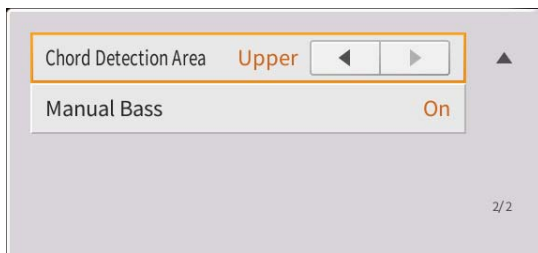

Chord Detection Area	<p>Select "Upper." The Chord section is set to the right of the Left Split Point. Fingering type is set to "Fingered*" automatically.</p> <p>NOTE "Fingered*" is basically same as "Fingered," except that "1+5," "1+8" and Chord Cancel are not available.</p> <p>NOTE When the Chord Detection Area is set to "Lower," the Chord section is set to the left of the Style Split Point. For details, refer to the Owner's Manual, Chapter 4.</p>
Manual Bass	<p>When this is set to "On," the bass part of the current Style is muted and the Voice of left part is assigned.</p> <p>NOTE This parameter is available only when the "Chord Detection Area" is set to "Upper."</p>



Learning How To Play Specific Chords (Chord Tutor)

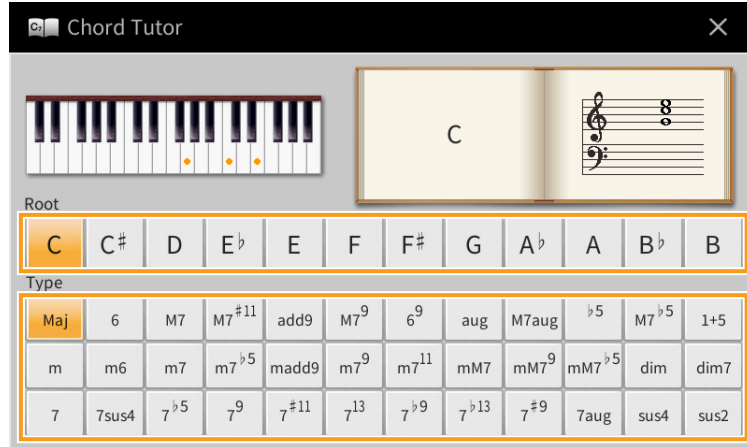

If you know the name of a chord but don't know how to play it, this function indicates you the notes you should press.

Root	Lets you select the desired Chord Root.
Type	Lets you select the desired Chord Type.

NOTE Depending on the chord, some notes may be omitted.



Adjusting the Volume Balance

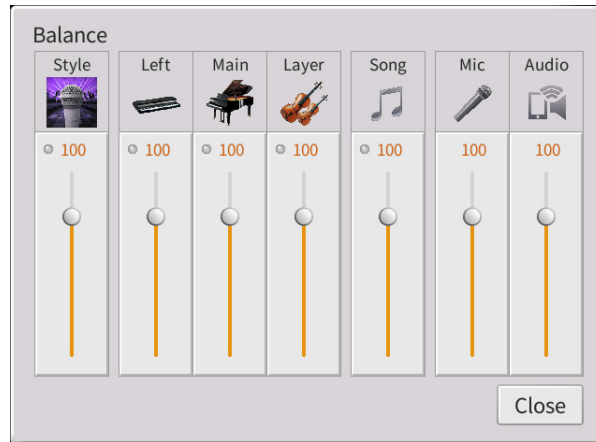

For information about this display, refer to the Owner's Manual, Chapter 1.



Editing the Volume and Tonal Balance (Mixer)

The “Panel” – “Audio” Part Selection tabs at the top of the Mixer display let you adjust the sound for each corresponding part, while “Master” lets you make overall sound adjustments for the entire instrument.

NOTE When an Audio Song is selected, you cannot set the parameters related to the Song part or channels.

NOTE Knobs and sliders appear on the setting displays only when the relevant parameters are available.

For a visual indication of the signal flow and configuration of the Mixer, refer to the Block Diagram on [page 17](#).

Filter

This function modifies the tonal characteristics (brightness, etc.) of the sound by cutting the output of a specific frequency portion of the sound. This is not available when you select “Master” from among the tabs at the top of the Mixer display.



Harmonic Content	Allows you to adjust the Resonance effect (page 49) for each part. This can be used in combination with the “Brightness” parameter to add further character to the sound.
Brightness	Determines the brightness of the sound for each part by adjusting the cutoff frequency (page 49).

EQ (Equalizer)

Equalizer (also called “EQ”) is a sound processor that divides the frequency spectrum into multiple bands that can be boosted or cut as required to tailor the overall frequency response. The “Panel” – “Song Ch9-16” Part Selection tabs at the top of the Mixer display let you adjust the EQ for each corresponding part, while “Master” lets you make overall EQ adjustments for the entire instrument.

Part EQ (when one of the “Panel” – “Song Ch 9-16” tabs is selected)



High	Boosts or attenuates the high EQ band for each part.
Low	Boosts or attenuates the low EQ band for each part.

Master EQ (when the “Master” tab is selected)

This instrument possesses a high-quality five-band digital EQ. With this function, a final effect — tone control — can be applied to the output of your instrument. You can select one of the five preset EQ types in the “Master” display. You can even create your own custom EQ settings by adjusting the frequency bands, and save the settings to one of two User Master EQ types.

NOTE Master EQ cannot be applied to Audio playback or the Metronome sound.

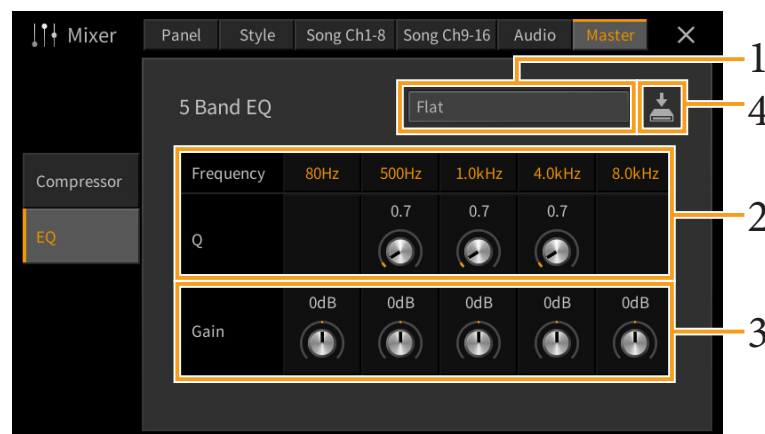
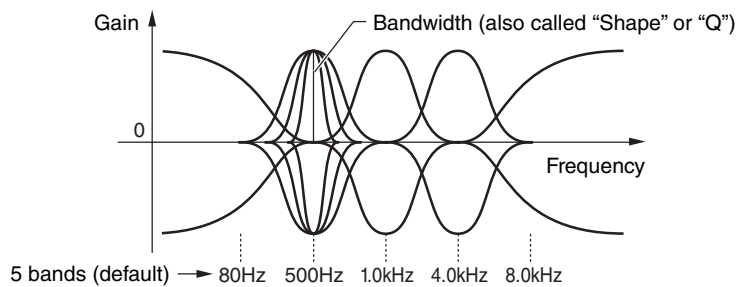

1 Select the desired EQ type to be edited.

- **Flat:** Flat EQ settings. The gain of each frequency is set to 0dB.
- **Light:** EQ setting for decreasing the level of the low frequencies, making the sound clearer.
- **Heavy:** EQ setting for boosting the level of the low frequencies, making the sound more powerful.
- **Mellow:** EQ setting for decreasing the level of the high frequencies, making the sound more mellow.
- **Bright:** EQ setting for boosting the level of the high frequencies, making the sound brighter.
- **User1–30:** Your own custom EQ settings saved in step 4.

2 Adjust the Q (bandwidth) and the Center Frequency of each band.

The available Frequency range is different for each band. The higher the value of Q, the narrower the bandwidth.

3 Boost or cut each of the five bands as desired.

4 Touch (Save) then save the settings as a User Master EQ type.

Up to two EQ types can be created and saved.

NOTICE

The settings will be lost if you turn the power to the instrument off without executing the Save operation.

NOTE If you want to save the Master EQ settings to the USB flash drive, save as a User Effect file. To do this, from the display called up via [Menu] → [Utility] → [Factory Reset/Backup] → page 2/2, touch [Backup] of “User Effect” to execute the Save operation (page 105).

Effects

This instrument features the following Effect Blocks.

- **System Effect (Chorus, Reverb):** These Effects are applied to the entire sound of this instrument. For each part, you can adjust the depth of the System Effect. Refer to “Chorus/Reverb” (page 14).
- **Insertion Effect 1 – 28 (CVP-809) / Insertion Effect 1 – 8 (CVP-805):** These Effects are applied only to a specific part. For each of these Effects, select an Effect type specifically for the desired part (for example, Distortion, which would be applied only to the Guitar part).
- **Variation Effect:** This Block can be used both as System Effects and Insertion Effects, and you can switch between them.

These explanations cover the settings related to the Insertion Effects and Variation Effects on the Effect display. This display is not available when the “Master” tab is selected at the top of the Mixer display.



<p>Insertion Effect</p>	<p>Lets you assign the desired Insertion Effect Type for each part by touching the area above each knob. You can adjust the degree to which each Effect is applied by using the knobs. If you want to assign each of the Insertion Effects to a specific Part and select an Effect Type, touch  (Setting) at the upper right of this area and make necessary settings in the window. The assignable Parts for each Insertion Effect are as follows:</p> <ul style="list-style-type: none"> ■ CVP-809 <ul style="list-style-type: none"> • Insertion Effect 1 – 19: Keyboard Parts, Song channels 1 – 16 • Insertion Effect 20: Microphone, Song channels 1 – 16 • Insertion Effect 21 – 28: Style Parts ■ CVP-805 <ul style="list-style-type: none"> • Insertion Effect 1 – 5: Keyboard Parts, Song channels 1 – 16 • Insertion Effect 6: Microphone, Song channels 1 – 16 • Insertion Effect 7 – 8: Style Parts
<p>Variation Effect</p>	<p>Touch [Insertion] or [System] to switch the Effect Connection between the Insertion Effect and System Effect, then touch the right end of this line to select the desired Effect type. When “System” is selected, this Effect is applied to all parts of the Song and Style as the System Effect. When “Insertion” is selected, this Effect is applied only to the specified Song/Style part. To adjust the degree to which the Effect is applied, use the knob of each part.</p>

NOTE For details about the Effect types, refer to the “Effect Type List” in the Data List (separate PDF).

Editing and Saving the Effect settings

You can edit the settings of the System Effects (Chorus, Reverb), Insertion Effects and Variation Effect. The edits can be saved as a User Effect type.

- 1** From the Mixer display, touch the desired Effect type to call up the Effect Type Selection display.
- 2** Select the Effect type if necessary, then touch  (Setting) to call up the Effect Parameter display.

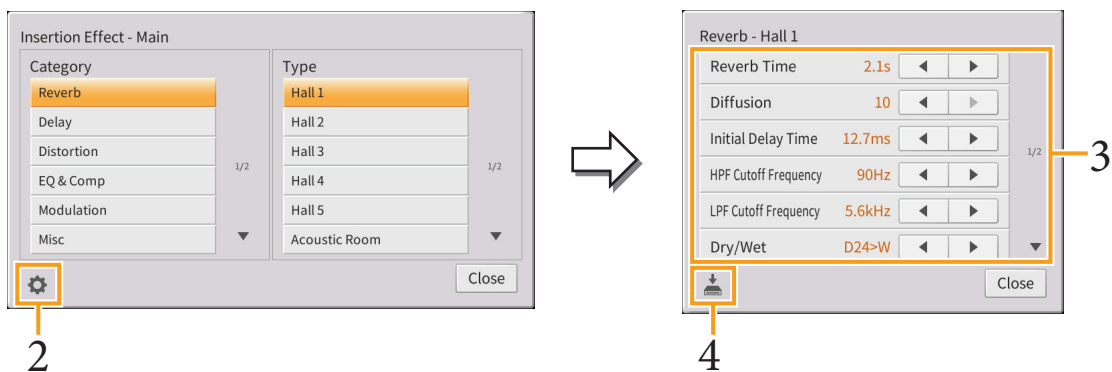

- 3** Make the necessary setting for each parameter.
The available parameters differ depending on the Effect type.

NOTE Parameters that are grayed out cannot be edited.

- 4** Touch  (Save), then save the settings as a User Effect type.
Up to 30 Effect types can be stored for each of the Effect Blocks.

NOTICE

The settings will be lost if you turn the power to the instrument off without executing the Save operation.

NOTE If you want to save the Effect settings to a USB flash drive, save as a User Effect file. To do this, from the display called up via [Menu] → [Utility] → [Factory Reset/Backup] → page 2/2, touch [Backup] of “User Effect” to execute the Save operation (page 105).

Chorus/Reverb

As described in the previous section, Chorus and Reverb are System Effects which are applied to the entire sound of the instrument. They are not available when the “Master” tab is selected at the top of the mixer display.



Chorus	Touch the Chorus type name at the top right of this row to select the desired Chorus type. After selecting, return to the Mixer display then use each knob to adjust the Chorus depth for each part.
Reverb	Touch the Reverb type name at the top right of this row to select the desired Reverb type. After selecting, return to the Mixer display then use each knob to adjust the Reverb depth for each part.

When VRM Voices are selected, “VRM” indications appear under the knobs of the parts. If VRM Voices are selected for multiple parts, the Chorus depth and the Reverb depth are applied commonly to all these parts.

NOTE For details about the Chorus and Reverb types, refer to the “Effect Type List” in the Data List (separate PDF).

Editing and Saving the Chorus/Reverb settings

Same as the operation on the “Effect” display (page 13).

Pan/Volume

You can adjust the Pan (stereo position of the sound) and Volume for each Part. This display is not available when the “Master” tab is selected at the top of the Mixer display.



❶	Pan	Determines the stereo position of each part (channel).
❷	Volume	Determines the level of each part or channel, giving you fine control over the balance of all the parts.

Master Compressor

Compressor is an effect commonly used to limit and compress the dynamics (softness/loudness) of an audio signal. For signals that vary widely in dynamics, such as vocals and guitar parts, it “squeezes” the dynamic range, effectively making soft sounds louder and loud sounds softer. When used with gain to boost the overall level, this creates a more powerful, more consistently high-level sound.

This instrument features a Master Compressor which is applied to the entire sound of this instrument. Although preset Master Compressor settings are provided, you can also create and save your original Master Compressor presets by adjusting the related parameters. This display is available only when the “Master” tab is selected at the top of the Mixer display.

NOTE Master Compressor cannot be applied to Audio playback or the Metronome sound.

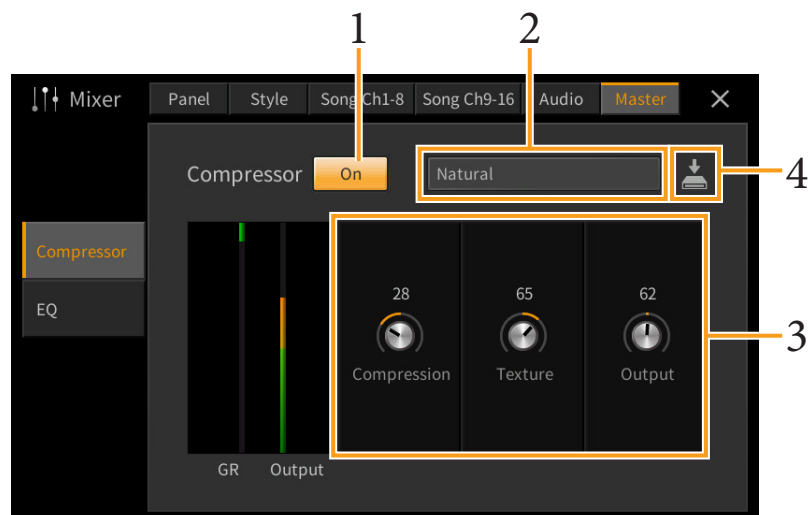

1 Set the Compressor to “On.”

2 Select the Master Compressor type to be edited.

- **Natural:** Natural Compressor settings in which the effect is moderately pronounced.
- **Rich:** Rich Compressor settings in which the instrument’s characteristics are optimally brought out. This is good for enhancing acoustic instruments, jazz music, etc.
- **Punchy:** Highly exaggerated Compressor settings. This is good for enhancing rock music.
- **Electronic:** Compressor settings in which the electronic dance music’s characteristics are optimally brought out.
- **Loud:** Powerful Compressor settings. This is good for enhancing energetic music such as rock or gospel music.
- **User1–30:** Your own custom Compressor settings saved in step 4.

3 Edit the parameters related to the Master Compressor.

Compression	Parameters such as Threshold, Ratio and Soft Knee (which are available on commonly used compressors) are all changed together at the same time, letting you moderately compress the sound.
Texture	Adds natural characteristics to the effect. The higher the value, the lighter it becomes. NOTE It may be easier to hear the changes when used in combination with “Compression” and “Output.”
Output	Determines the output level.

The indication “GR” shows the Gain Reduction (compressed level) while “Output” shows the output level according to the instrument sound in real time.

4 Touch (Save), then save the settings as a User Master Compressor type.

Up to 30 Master Compressor types can be created and saved.

NOTICE

The settings will be lost if you turn the power to the instrument off without executing the Save operation.

NOTE If you want to save the Master Compressor settings to a USB flash drive, save them as a User Effect file. To do this, from the display called up via [Menu] → [Utility] → [Factory Reset/Backup] → page 2/2, touch [Backup] of “User Effect” to execute the Save operation ([page 105](#)).

Block Diagram

CVP-809

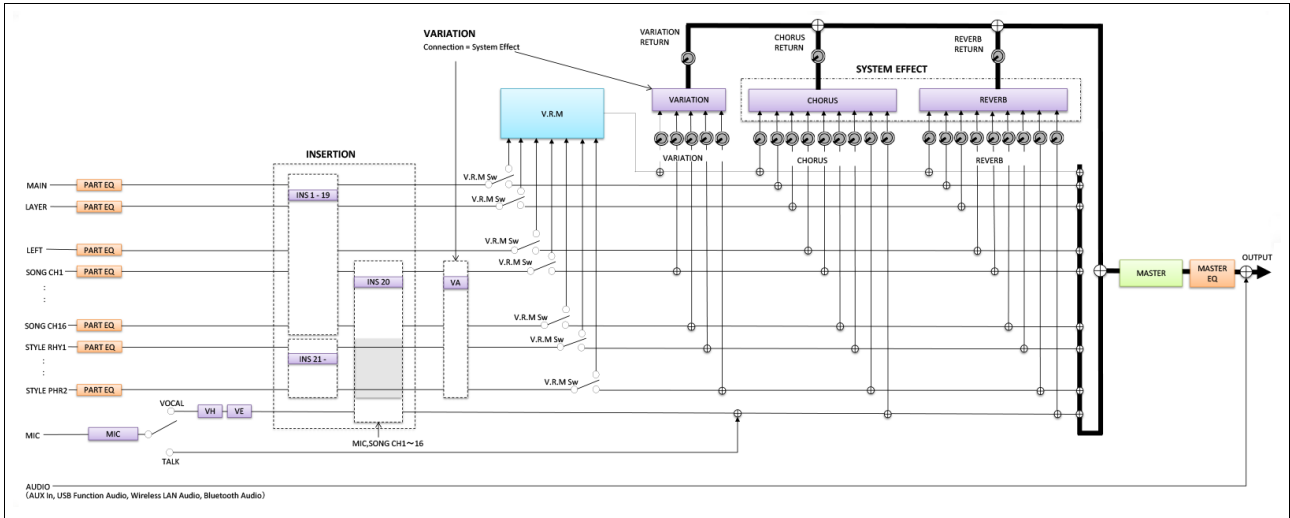

CVP-805

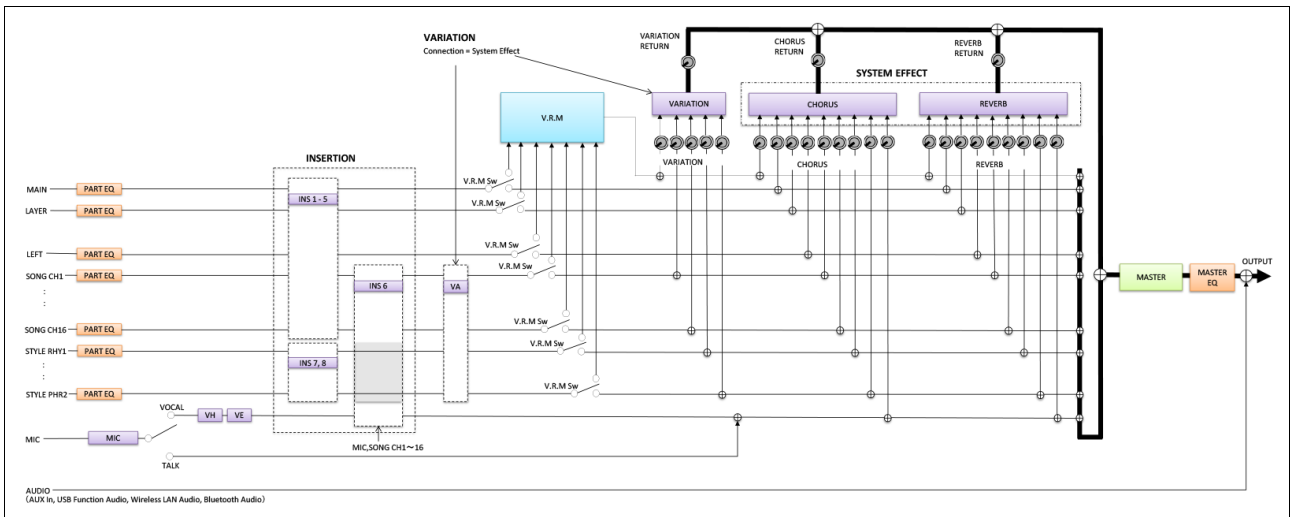

* MIC EFFECT = 3 Band EQ/Noise Gate/Compressor, VH = Vocal Harmony, VE = Vocal Harmony Effect



Score

Editing Music Notation (Score) Settings

Select a MIDI Song then touch [Score] to call up the music notation of the current MIDI Song. You can change the notation indication as desired to suit your personal preferences.

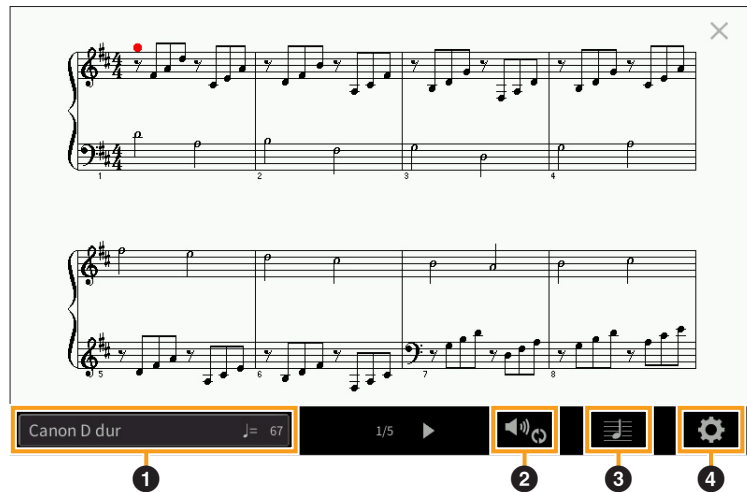

❶	Indicates the name of the current Song. Also, the tempo value is shown at the right end. If you want to change the Song, touch the Song name to call up the Song Selection display.
❷	Lets you set the parameters related to playback Parts of the MIDI Song. For details, refer to “Play Setting” (page 18).
❸	Lets you set the notation indication parameters, including notation size, chord display, etc. For details, refer to “View Setting” (page 19).
❹	Lets you set more detailed parameters related to the notation indication. Refer to “Detail Setting” (page 19).

Play Setting

From the display called up via (Play Setting), you can set the parameters related to playback of the current MIDI Song. The parameters explained here can also be set on the Song area (with expanded) of the Home display.

Extra	Turns playback of all Channels on or off, except for those assigned to the Left and Right Hand Parts described below.
Left	Turns playback on or off for the Left Hand Part, to which you can assign the desired channel on the Song Setting display (page 88).
Right	Turns playback on or off for the Right Hand Part, to which you can assign the desired channel on the Song Setting display (page 88).
Guide	Turns the Guide function on or off. For details, refer to the Owner’s Manual, Chapter 5.
	Turns Repeat playback on or off and lets you specify the Repeat playback range. For details, refer to the Owner’s Manual, Chapter 5.

View Setting

From the display called up via  (View Setting), you can set the parameters related to the view of the notation.

Size	Determines the display resolution (or zoom level) of the notation.
Left	Turns indication of the left-hand notation on or off. If an “-” indication appears at this parameter and is unavailable, go to the “Detail Setting” display (page 19), then set the Left Ch to any channel except “Auto.” Or, on the display called up via [Menu] → [SongSetting] → [Part Ch], then set the Left to any channel except “Off” (page 88). NOTE Both Right (below) and Left cannot be turned off at the same time.
Right	Turns indication of the right-hand notation on or off. NOTE Both Right and Left (above) cannot be turned off at the same time.
Chord	Turns indication of the chords on or off. If the current Song does not contain chord data, no chord information is shown even if this is checked.
Lyrics	Turns indication of the Lyrics on or off. If the current Song does not contain lyrics data, no lyrics are shown even if this is checked. If the Song contains Pedal events, touching here switches between “Lyrics” and “Pedal.” When “Pedal” is checked, Pedal events are shown instead of Lyrics on the display.
Note	Turns indication of the Note names on or off. When this is checked, each note name is shown at the left side of each note. If the Song contains Fingering events, touching here switches between “Note” and “Fingering.” When “Fingering” is checked, Fingering events are shown instead of Note names on the display.
Color	When this is checked, the notes in the display appear in identifying colors (C: red, D: yellow, E: green, F: orange, G: blue, A: purple, and B: gray).

Detail Setting

From the display called up via  (Detail Setting), you can set more detailed parameters.

Right Ch	Determines which MIDI channel in the MIDI Song data is used for the right-hand/left-hand part. This setting returns to “Auto” when a different Song is selected.
Left Ch	<ul style="list-style-type: none"> • Auto: The MIDI channels in the MIDI Song data for the right- and left-hand parts are assigned automatically — setting each part to the channel which has been specified at the Part Ch (page 88) on the Song Setting display. • 1–16: Assigns a specified MIDI channel (1–16) to each of the right- and left-hand parts. • Off (Left Ch only): No channel assignment. This disables display of the left-hand notation.
Key Signature	Lets you enter the Key Signature at the current stopped position of the MIDI Song. This setting is useful for Songs you’ve recorded with key changes, so the key signature changes are properly reflected in the notation.
Quantize	This gives you control over the note resolution in the notation, letting you shift or correct the timing of all displayed notes so that they line up to a particular note value. Make sure to select the smallest note value used in the Song.
Note Name	Selects the type of the note name indicated at the left of the note in the notation from among the following three types. The settings here are available when the Note parameter (page 19) is checked. <ul style="list-style-type: none"> • A, B, C: Note names are indicated as letters (C, D, E, F, G, A, B). • Fixed Do: Note names are indicated in solfeggio and differ depending on the selected language. • Movable Do: Note names are indicated in solfeggio according to the scale intervals, and as such are relative to the key. The root note is indicated as Do. For example, in the key of G major the root note of “Sol” would be indicated as “Do.” As with “Fixed Do,” the indication differs depending on the selected language.



Lyrics

Editing Lyrics Display Settings

After selecting a Song, you can call up the lyrics of the current Song (if it contains lyrics data) by touching [Lyrics]. You can change the lyrics indication as desired to suit your personal preferences.

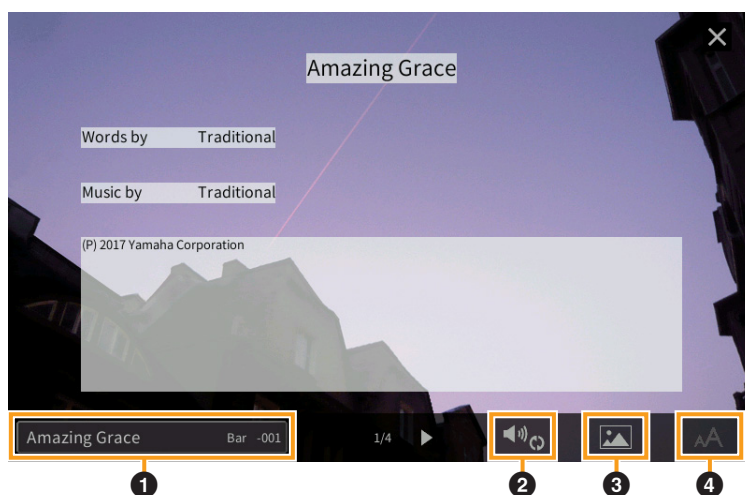

①	Indicates the name of the current Song. Also, the current measure number for the MIDI Song or the elapsed time for the Audio Song is shown at the right end. If you want to change the Song, touch the Song name here to call up the Song Selection display.
②	Lets you set the parameters related to playback, such as playback parts for the MIDI Song or the Vocal Cancel function for the Audio Song. For details, refer to “Play Setting” (page 18 for MIDI Songs, page 21 for Audio Songs).
③	Allows you to change the background picture of the Lyrics display and Text display. As well as various pictures provided in the Preset tab, you can select an original picture file (a bitmap file with no greater than 800 x 480 pixels) in the USB flash drive. The original picture file can be copied from the USB flash drive to the internal User memory. NOTE The setting here is applied also to the Text display.
④ (only Audio Songs)	Lets you select the font type. “Medium” keeps each character at the same width, and “Proportional Medium” changes the width depending on the characters.

NOTE When the lyrics are garbled or unreadable, you may need to change the Lyrics Language setting on the display called up via [Menu] → [SongSetting] → [Lyrics].



Priority of Lyrics data of an Audio Song (MP3 file)

When showing the lyrics data of an Audio Song (MP3 file), only one type of data (according to the priority order below) is shown:

- 1) CDG file (*.cdg) with the same name of the MP3 file in the same folder.
- 2) Lyrics in the MP3 file with the LYRICSBEGIN tag.
- 3) Lyrics in the MP3 file with the SLT/SYLT tag.
- 4) Lyrics in the MP3 file with the ULT/USLT tag.
- 5) Text file (*.txt) with the same name of the MP3 file in the same folder.

Play Setting (Audio Song)

From the display called up via  (Play Setting), you can set the parameters related to playback of the current Audio Song. The parameters explained here can also be set on the Song area (when expanded) of the Home display.

	Turns the Vocal Cancel function on/off. For details, refer to the Owner's Manual, Chapter 5.
	Turns the repeat playback on/off or specifies the repeat range. For details, refer to the Owner's Manual, Chapter 5.



TextViewer

Showing the Text Display and Editing Text Display Settings

Text files (.txt) of 60 KB or smaller created on a computer can be viewed on the instrument's display. This feature enables various useful possibilities, such as the showing of lyrics, chord names, and text notes.

Showing the Text Display

If you want to view the text in a USB flash drive, connect the USB flash drive containing text data to the [USB TO DEVICE] terminal beforehand.

1 Call up the Text display via [Menu] → [TextViewer].

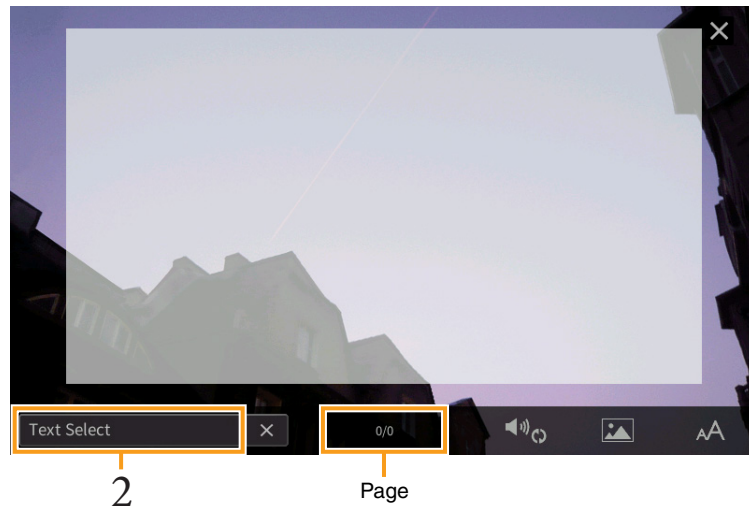

2 Touch the bottom left corner on the display to call up the Text File Selection display.

3 Select the desired text file, and touch [Close] to show the text in the display.

If the text extends over several pages, you can scroll through the entire text by touching [◀] or [▶], which are shown at the right and left of the page. To clear the text from the display, touch [X] located at right of the text file name.

- NOTE**
- Line breaks are not automatically entered in the instrument. If a sentence is not displayed in its entirety because of limitations in the screen space, enter line breaks manually on your computer by using a text editor, etc. beforehand.
 - Information about Text File selection can be memorized to the Registration Memory. For details, refer to the Owner's Manual, Chapter 8.
 - The preset text files are sample data for the Playlist function. For details about Playlist, refer to the Owner's Manual, Chapter 8.
 - The Text can be displayed on an external monitor or television. For details on instructions, refer to the Owner's Manual, Chapter 10.

Editing Text Display Settings

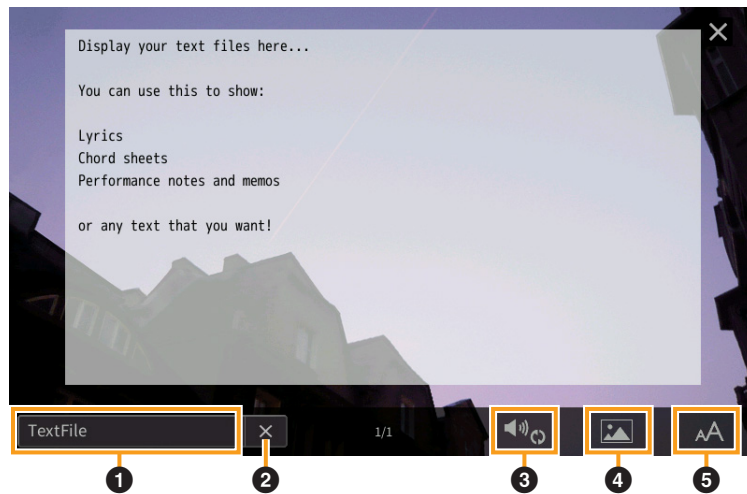

①	Indicates the current text file which is shown on the display. Touching here calls up the text File Selection display which lets you select an original text file in the USB flash drive or copy it from the USB flash drive to the internal User memory.
②	Clears the text from the display. This operation does not delete the text file itself, but simply leaves the display empty of any text file.
③	Lets you set the parameters related to playback Parts of the MIDI Song. For details, refer to “Play Setting” (page 18).
④	Allows you to change the background picture of the Lyrics display and Text display. As well as various pictures provided in the Preset tab, you can select your original picture file (a bitmap file with no greater than 800 x 480 pixels) in the USB flash drive. Your original picture file can be copied from the USB flash drive to the internal User memory. NOTE The setting here is applied also to the Lyrics display.
⑤	Lets you select the font size or type. “Small,” “Medium,” or “Large” keeps each character at the same width, and is suitable for displaying lyrics with chord names above, etc. “Proportional Small,” “Proportional Medium,” and “Proportional Large” are suitable for displaying lyrics without chord names or explanatory notes.

NOTE When the text is garbled or unreadable, you may need to change the language setting on the display called up via [Menu] → [Utility] → [System].

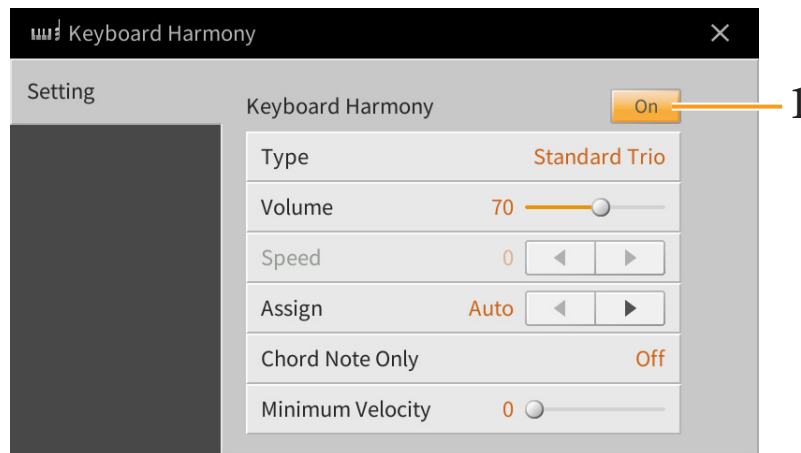

1 Set the Keyboard Harmony function to “On.”

When this is set to “On,” Harmony or Echo is applied to your keyboard performance automatically.

2 Adjust related parameters such as Harmony type and volume.

NOTE The available parameters differ depending on the Harmony type.

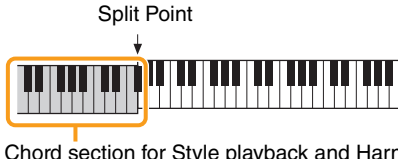
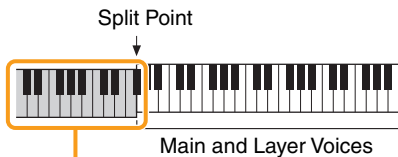
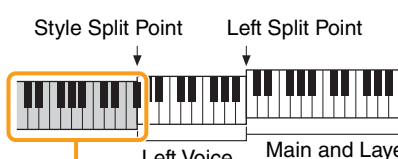
Type	<p>Lets you select one of the Harmony types, which are divided into the following groups.</p>
	<p>■ Harmony Type (Standard Duet — Strum)</p> <p>These types apply the harmony effect to notes played in the right-hand section of the keyboard according to the chord specified in the left-hand section of the keyboard. (Note that the “1+5” and “Octave” settings are not affected by the chord.)</p> <p>If you want to use these types with the Style stopped, set the “Stop ACMP” parameter to a setting other than “Disabled” in the Style Setting display (page 84).</p> <p>When [ACMP ON/OFF] is turned on:</p>  <p>When the Left part is on:</p>  <p>When [ACMP ON/OFF] and the Left part are on:</p> 

Type	<p>■ Multi Assign The Multi Assign effect automatically assigns notes played simultaneously on the right-hand section of the keyboard to separate parts (Voices). Both of the keyboard parts [Main] and [Layer] should be turned on when using the Multi Assign effect. The Main and Layer Voices are alternately assigned to the notes in the order you play.</p> <p>■ Echo Type (Echo, Tremolo and Trill) When one of the Echo Types is selected, the corresponding effect (echo, tremolo, trill) is applied to the note played in the right-hand section of the keyboard in time with the currently set tempo, regardless of the [ACMP ON/OFF] and the Left part on/off status. Keep in mind that Trill only works when you hold down two notes on the keyboard simultaneously (last two notes if more than two notes are held), and it plays those notes alternately.</p>
Volume	This parameter is available for all types with the exception of “Multi Assign.” It determines the level of the harmony/echo notes generated by the Harmony/Echo effect.
Speed	This parameter is only available when Echo, Tremolo, or Trill is selected in Type above. It determines the speed of the Echo, Tremolo, and Trill effects.
Assign	<p>This parameter is available for all types with the exception of “Multi Assign.” This lets you determine the keyboard part via which the harmony/echo notes will be sounded.</p> <ul style="list-style-type: none"> • Auto: Applies the effect to the part which is turned on. When the both parts are on, the Main part is given priority over the Layer part. • Multi: When both parts are on, the note played on the keyboard is sounded by Main part and the harmonies (effect) are divided to the Main and Layer parts. When only one part is on, the note played on the keyboard and effect are sounded by that part. • Main, Layer: Applies the effect to the selected part (Main or Layer).
Chord Note Only	This parameter is available when one of the Harmony Types is selected. When this is set to “On,” the Harmony effect is applied only to notes (played in the right-hand section of the keyboard) that belong to a chord played in the chord section of the keyboard.
Minimum Velocity	This parameter is available for all types with the exception of “Multi Assign.” It determines the lowest velocity value at which the harmony note will sound. This allows you to selectively apply the harmony by your playing strength, letting you create harmony accents in the melody. The harmony effect is applied when you play the key strongly (above the set value).

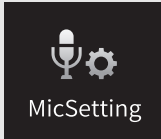

Microphone Settings

This section lets you set parameters for various Effects that are applied to the microphone sound. You should make both “Vocal” and “Talk” settings — “Vocal,” for your singing performance, and “Talk,” for making announcements between songs, for example.

When “Vocal” is selected:

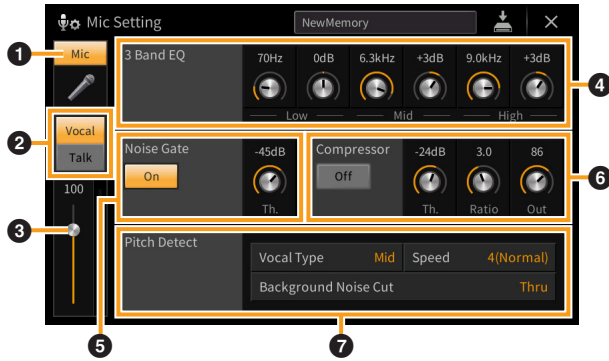

When “Talk” is selected:

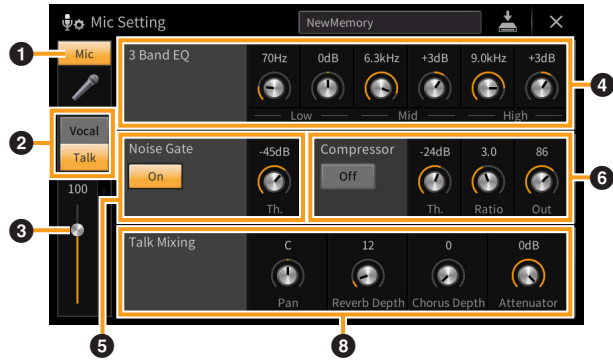

1	Microphone On/Off	Turns on or off the microphone sound. When set to On, the microphone sound will be input to the instrument. NOTE The setting here is equivalent to that in the Vocal Harmony display (page 28).								
2	Vocal/Talk Switch	When you sing into the microphone for your performance, set this to “Vocal.” When you talk normally or need to make announcements between songs of your performance, set this to “Talk.” This lets you instantly change the microphone settings depending on the situation. NOTE The setting here is equivalent to that in the Vocal Harmony display (page 28).								
3	Volume Adjustment	Adjusts the input volume of the microphone sound. The input level is shown at the right. NOTE The setting here is equivalent to that in the Vocal Harmony display (page 28).								
4	3 Band EQ	EQ (Equalizer) is a processor that divides the frequency spectrum into multiple bands which can be boosted or cut as required to tailor the overall frequency response. The instrument features a three-band (Low, Mid and High) digital equalizer function for the microphone sound. For each of three bands, you can adjust the center frequency (Hz) and level (dB) via the corresponding knobs on the display.								
5	Noise Gate	This effect mutes the input signal when the input from the microphone falls below a specified level. This effectively cuts off extraneous noise, allowing the desired signal (vocal, etc.) to pass. <table border="1" style="width: 100%; border-collapse: collapse;"> <tr> <td style="width: 20%;">On/Off</td> <td>Turns Noise Gate on or off.</td> </tr> <tr> <td>Th. (Threshold)</td> <td>Adjusts the input level above which the gate begins to open.</td> </tr> </table>	On/Off	Turns Noise Gate on or off.	Th. (Threshold)	Adjusts the input level above which the gate begins to open.				
On/Off	Turns Noise Gate on or off.									
Th. (Threshold)	Adjusts the input level above which the gate begins to open.									
6	Compressor	This effect holds down the output when the input signal from the microphone exceeds a specified level. This is especially useful for smoothing out vocals that have widely varying dynamics. It effectively “compresses” the signal, making loud parts softer, or vice versa. <table border="1" style="width: 100%; border-collapse: collapse;"> <tr> <td style="width: 20%;">On/Off</td> <td>Turns Compressor on or off.</td> </tr> <tr> <td>Th. (Threshold)</td> <td>Adjusts the input level above which compression begins to be applied.</td> </tr> <tr> <td>Ratio</td> <td>Adjusts the compression ratio. Higher ratios result in a more compressed sound, with a reduced dynamic range.</td> </tr> <tr> <td>Output</td> <td>Adjusts the final output level.</td> </tr> </table>	On/Off	Turns Compressor on or off.	Th. (Threshold)	Adjusts the input level above which compression begins to be applied.	Ratio	Adjusts the compression ratio. Higher ratios result in a more compressed sound, with a reduced dynamic range.	Output	Adjusts the final output level.
On/Off	Turns Compressor on or off.									
Th. (Threshold)	Adjusts the input level above which compression begins to be applied.									
Ratio	Adjusts the compression ratio. Higher ratios result in a more compressed sound, with a reduced dynamic range.									
Output	Adjusts the final output level.									

⑦	Pitch Detect (only when “Vocal” is selected)	Lets you set how the pitch of the microphone sound during performance is detected.	
		Vocal Type	Set this to obtain the most natural vocal harmony, depending on your voice. <ul style="list-style-type: none"> • Low: Setting for lower voices. This setting is also appropriate for growling and shouting. • Mid: Setting for mid-range voices. • High: Setting for higher voices. This setting is also appropriate for singing close to the microphone. • Full: Setting for vocalists having a wide range, from low to high.
		Speed	Adjusts the response speed of the Vocal Harmony effect, or how quickly harmonies are generated in response to your voice. The larger the number, the faster the response. NOTE When one or both of Lead Pitch Detect Speed and Harm Pitch Detect Speed parameters of Vocal Harmony (page 31) are set to “as MIC SETTING,” this parameter is effective. In other settings, the setting of the Vocal Harmony’s Pitch Detect Speed is effective.
		Background Noise Cut	This allows you to filter out noises that would interfere with the pitch detection. A setting of “Thru” turns the noise filter off.
⑧	Talk Mixing (only when “Talk” is selected)	Lets you make settings for talking or making announcements between songs during a performance.	
		Pan	Determines the stereo pan position of the microphone sound.
		Reverb Depth	Determines the depth of the reverb effects applied to the microphone sound.
		Chorus Depth	Determines the depth of the chorus effects applied to the microphone sound.
Attenuator	Determines the amount of reduction to be applied to the overall sound (excepting the microphone input) — allowing you to effectively adjust the balance between your voice and the overall instrument sound.		

NOTICE

The settings here are lost if you turn off the power without executing the Save operation.

NOTE When “Vocal” is selected, you can adjust Reverb/Chorus settings for your singing voice on the Mixer display (page 14).

Storing the Microphone Settings

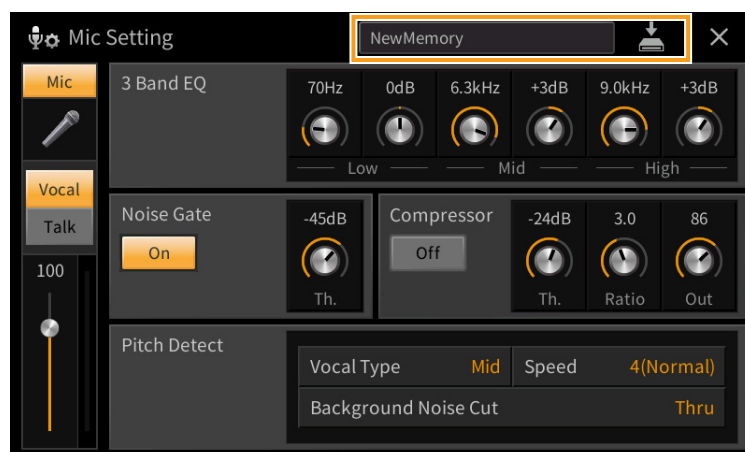

You can store the microphone settings by touching  (Save) then selecting one of 60 User Memories. For ease in future recall, you should assign a sufficiently descriptive name or one that matches your performance.

To call up the microphone settings, touch the setting name at left of  (Save) then select the desired file.

NOTE If you want to save the microphone settings to a USB flash drive, save as a User Effect file. To do this, on the display called up via [Menu] → [Utility] → [Factory Reset/Backup] → page 2/2, touch [Backup] of “User Effect” to execute the Save operation (page 105).

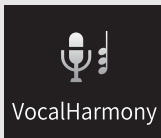

Vocal Harmony Settings

This section allows you to set various Vocal Harmony parameters, even though just selecting a Vocal Harmony Type will call up the appropriate settings and you need not edit these parameters normally. If you want to make more detailed settings for your performance, read this chapter.

Basic Parameters

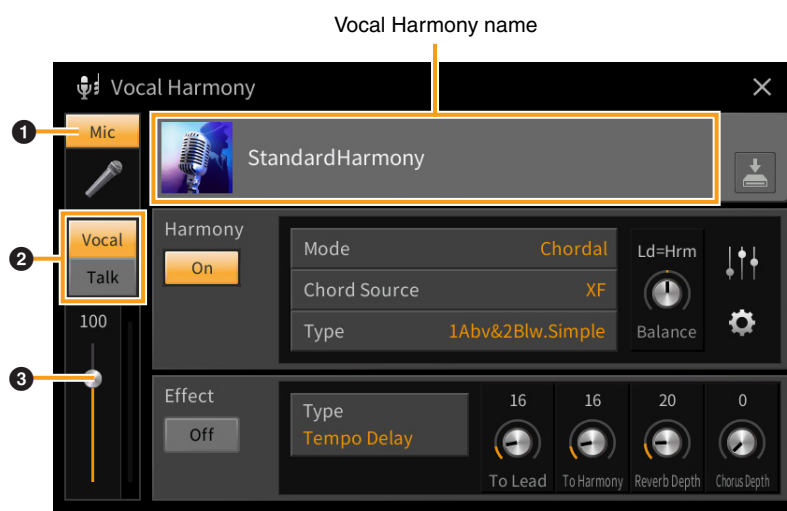

❶	Microphone On/Off	Turns the microphone sound on or off. When this is set to On, the microphone sound is input to the instrument.
❷	Vocal/Talk Switch	When you sing into the microphone, this should be set to “Vocal.” When you talk normally or make announcements between songs, this should be set to “Talk.” If you want to set the Vocal Harmony parameters, this should be set to “Vocal.”
❸	Volume Adjustment	Adjusts the input volume of the microphone sound. The input level is shown at the right.

NOTE The settings here are equivalent to those in the Microphone Setting display ([page 26](#)).

Editing the Vocal Harmony Type

By editing the parameters of the preset Vocal Harmony type, you can create your original Vocal Harmony type.

- 1 Touch the Vocal Harmony name to call up the Vocal Harmony Selection display.
- 2 Select the desired Vocal Harmony type.
- 3 Depending on the selected Vocal Harmony type, edit the relevant settings as desired.

When the Mode (2) is set to "Chordal":

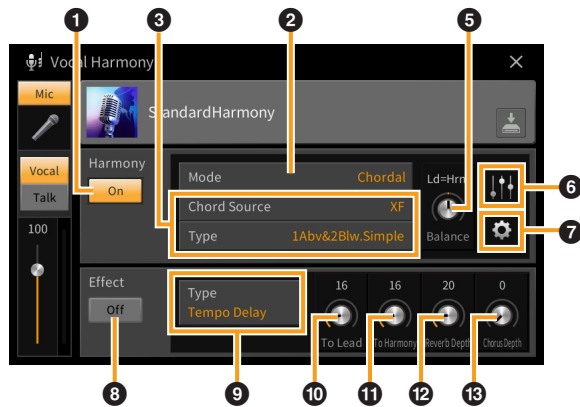

When the Mode (2) is set to "Vocoder" or "Vocoder-Mono":

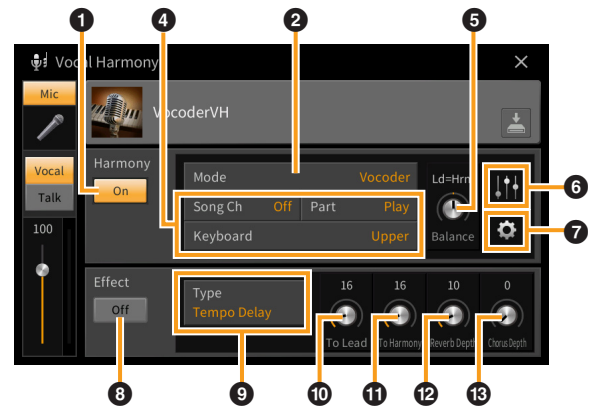

■ Harmony

Lets you edit the Vocal Harmony parameters.

1	Harmony On/Off	Turns Vocal Harmony on or off.	
2	Mode	Although one of the three following Modes is automatically selected when a Vocal Harmony type is selected, you can change the Mode.	
		Chordal	The harmony notes are determined by the following three chord types: chords played in the chord section of the keyboard (with [ACMP ON/OFF] turned on), chords played in the left hand section of the keyboard (with the Left part turned on), and chords contained in Song data for controlling the harmony. (Not available if the Song does not contain any chord data.) NOTE If you want to apply Vocal Harmony by pressing the chords in the chord section when the Style is stopped, you need to set the "Stop ACMP" parameter to a setting other than "Disabled" in the Style Setting display (page 84).
		Vocoder	The microphone sound is output via the notes you play on the keyboard or via the Song playback notes.
	Vocoder-Mono	Basically the same as the Vocoder. In this mode, only single-note melodies or lines can be played back (with last-note priority).	
3	(When the Mode is set to "Chordal")		
	Chord Source	Determines which data or event of a Song will be used for chord detection. <ul style="list-style-type: none"> • Off: Detects no chord from the Song data. • XF: Chord data defined via XF will be used. • 1 – 16: Detects a chord from notes of the MIDI channel specified here. 	

③	Type	<p>Determines how the harmony notes are applied to the microphone sound by selecting one of the Chordal Types. Almost all Types apply the harmony notes based on the chord specified via the left hand section of the keyboard, chord section of the keyboard, or the Song data, with the exception of the following two Types. For details, refer to the “Vocal Harmony Parameter List” in the Data List (separate PDF.)</p> <ul style="list-style-type: none"> • ScaleDiatonic: This generates harmony notes based on the Key Root and Key Type specified in the Harmony Assign display (⑦), meaning that the harmony notes do not depend on the chord but match the diatonic scale of the current song’s key signature. • Parallel: This adds a note to the lead note (microphone sound) with the interval specified at ⑥, regardless of the chord. <p>NOTE “Abv” in the Chordal Type List means that the harmony notes are generated above the lead note (microphone sound) while “Blw” means that the harmony notes are generated below the lead note.</p> <p>For more information about the Chordal Types, refer to “Vocal Harmony Parameter List” in the Data List (separate PDF).</p>
④	(When the Mode is set to “Vocoder” or “Vocoder-Mono”)	
	Song Ch	When set to one of 1 – 16, note data (played from a Song on this instrument or the connected computer) of the corresponding channel is used to control the harmony. When set to “Off,” Song data control over harmony is turned off.
	Part	When set to “Mute,” the channel selected above (to control Harmony) is muted (turned off) during Song playback, allowing you to disable control via specific channels as desired.
	Keyboard	<ul style="list-style-type: none"> • Off: Keyboard control over harmony is turned off. • Upper: Notes played to the right of the Split Point control the harmony. • Lower: Notes played to the left of the Split Point control the harmony.
⑤	Balance	Lets you set the balance between the lead vocal (the microphone sound) and Vocal Harmony sound. Raising this value increases the volume of the Vocal Harmony and decreases that of the lead vocal. When this is set to L<H63 (L: Lead Vocal, H: Vocal Harmony), only the Vocal Harmony is output; when it is set to L63>H, only the lead vocal is output.
⑥	Balance adjustment for each Lead note and Harmony note	<p>The following parameters can be adjusted for each Lead note (microphone sound) and Harmony note.</p> <ul style="list-style-type: none"> • Transpose/Degree: Lets you shift the pitch for each Harmony note and Lead note. The range for all notes is the same; however, the lead note can only be adjusted in octaves. When the Chordal Type is set to “ScaleDiatonic,” this parameter changes to Degree, letting you shift the pitch in degree from -3 octaves (-22 scale degrees) – Unison (1 scale degree) – +3 octaves (+22 scale degrees). • Detune: Determines the fine pitch setting for each Harmony note from -50 cents to +50 cents. • Formant: Determines the formant setting for each Harmony note. The higher the value, the more “feminine” the harmony voice becomes. The lower the value, the more “masculine” the voice. • Pan: Determines the pan position setting for each Harmony note. Setting each Harmony note to a different pan position, with the Lead vocal at center, for example, results in a naturally wide stereo sound. • Volume: Determines the volume setting for each Harmony note. Use this to adjust the relative level balance among the Lead vocal and the Harmony notes. <p>NOTE When Pitch Correct Mode (⑦) is set to OFF the Lead part is not available for the Transpose/Degree, Detune and Formant parameters.</p> <p>NOTE The Transpose values of the Harmonies are available only when the Mode (②) is set to “Chordal.”</p>

7	Harmony Assign	<p>Lets you set how the Harmony notes are assigned or voiced to the Lead note (microphone sound). For details, refer to “Vocal Harmony Parameter List” in the Data List (separate PDF).</p> <p>■ When the Harmony mode is set to “Chordal”</p> <ul style="list-style-type: none"> • Session Table: Determines how the harmonies will be voiced, or what type of chord will be used in creating the harmonies, according to different musical styles. • NOTE This parameter is available only when the Chordal Type is set to something other than ScaleDiatonic or Parallel. • Key Root, Key Type: When the Chordal Type (8) is set to “ScaleDiatonic,” this parameter is available. Harmony notes based on the settings here do not depend on the chord but match the diatonic scale of the current song’s key signature. <p>■ When the Harmony mode is set to “Vocoder” or “Vocoder-Mono”</p> <ul style="list-style-type: none"> • Transpose Mode: Determines the amount by which the harmony parts are transposed. A setting of “0” results in no transposition, while the “Auto” setting results in automatic transposition.
	Detail Setting	<ul style="list-style-type: none"> • Pitch Correct Mode: Corrects the pitch of the Lead note (microphone sound). “Off” does not correct while “Hard” corrects the pitch most accurately. • Humanize: This setting allows you to make the Vocal Harmony sounds more natural and less “electronic,” by introducing slight time discrepancies between the Lead and Harmony notes. <ul style="list-style-type: none"> Off: No Humanize effect. 1: The Humanize effect is applied to the Harmony to create a more natural feel, with an authentic-sounding widening effect, giving the impression of more people singing. 2: The Humanize effect is applied to the Harmony to produce a more distinct groove. Even faster passages retain their rhythmic essence. 3: The Humanize effect is applied to the Harmony to reflect the way in which the lead vocalist and back chorus interact, with the lead vocal out front, and the timing slightly relaxed. • Lead Pitch Detect Speed, Harm Pitch Detect Speed: Determines how fast the pitch of the Lead note and the harmony notes are detected in response to the signal via the microphone. “1” responds most slowly, “4” is standard, “15” responds most quickly, and “as MIC SETTING” gives priority to the speed specified at the Pitch Detect “Speed” of the Microphone Setting display (page 27). • Harmony Effect: Determines the Effect type applied to the Harmony notes added to the Lead note. • Harmony Stability: Determines the stability degree to which the Harmony is applied to the Lead note. When set to “Stable,” this has a relatively stable sound with little harmony motion. When set to “Dynamic,” this tends to add harmony with motion according to the input sound. • Lead Vibrato Depth: This specifies the vibrato depth of the lead sound. • Harm Vibrato Depth: This specifies the vibrato depth of the harmony sound. • Vibrato Speed: This specifies the vibrato speed of both the lead and harmony sounds. • Vibrato Delay: This specifies the vibrato delay of both the lead and harmony sounds. <p>For more information about the parameters of Detail Settings, refer to “Vocal Harmony Parameter List” in the Data List (separate PDF).</p>

■ Effect

Lets you edit the parameters related to the Effects applied to the Vocal Harmony notes.

8	Effect On/Off	Turns on or off the Effects applied to the Vocal Harmony notes.
9	Type	Selects the Effect type applied to the Vocal Harmony notes. You can edit also the detailed parameters of the selected type. For details, refer to “Vocal Effect Type List” and “Vocal Harmony Parameter List” in the Data List (separate PDF).
10	To Lead	Adjusts the Effect depth applied to the Lead note.
11	To Harmony	Adjusts the Effect depth applied to the Harmony notes.

12	Reverb Depth	Adjusts the Reverb depth applied to the microphone sound. This setting is equivalent to that in the Mixer display (page 14).
13	Chorus Depth	Adjusts the Chorus depth applied to the microphone sound. This setting is equivalent to that in the Mixer display (page 14).

4 Touch (Save), then save the edits as an original Vocal Harmony type.

Up to 60 Vocal Harmony types can be saved to User memory. For ease in future recall, you should assign a descriptive name that matches the settings.

NOTICE

The settings here are lost if you turn off the power without executing the Save operation.

NOTE If you want to save the Vocal Harmony settings to a USB flash drive, save as a User Effect file. To do this, on the display called up via [Menu] → [Utility] → [Factory Reset/Backup] → page 2/2, touch [Backup] of “User Effect” to execute the Save operation ([page 105](#)).



Playlist

Using Playlist

Importing Music Finder Records to the Playlist

By importing Music Finder Records (.mfd) used on previous Yamaha digital pianos (such as CVP-709, 705 etc.), you can use the Records on the Playlist of this instrument, just like using the Music Finder function on those other instruments. For details on using Music Finder, refer to the Owner's Manual of the Yamaha digital piano which contains your desired Music Finder Records.

- 1 Connect the USB flash drive which contains the Music Finder file (***.mfd) to the [USB TO DEVICE] terminal.**
- 2 On the Playlist display, touch the Playlist file name to call up the Playlist File Selection display.**

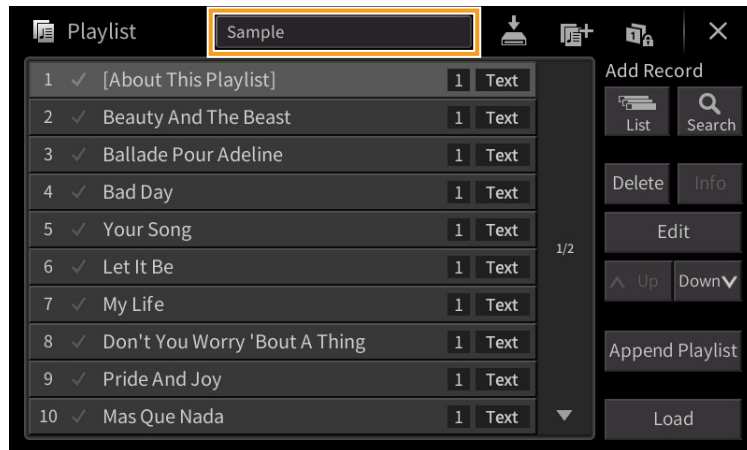

- 3 Select the desired Music Finder file to call up a confirmation message.**

- 4 Touch [Yes] to start importing.**

The imported Music Finder Records will be converted to Registration Memory Bank files and saved to a folder (with the same name as the imported file) in the User drive of this instrument. At the same time, a Playlist of the converted Registration Memory Bank files (with the same name as the imported file) will be created in the USB flash drive. The Music Finder settings are registered to the Registration Memory number [1] for each Bank.

NOTICE

If a folder with the same name as the Music Finder file already exists, the Registration Memory Bank file with the same name in that folder will be overwritten by the importing data. To avoid overwriting important data, change the folder name or the Music Finder file name.

- 5 Turn the [OTS LINK] button on to enable to use of the imported Records in the same way as the original Music Finder function.**



- 6 Touch the Record name on the Playlist display and load the settings contained in the Music Finder data.**

Searching for Records

Since Music Finder data is saved to Registration Memory, you can search for Records on the Registration Bank Selection display. The keyword and genre of the Music Finder are saved as tag information. For details about searching or tags, refer to the Owner's Manual, Chapter 8.

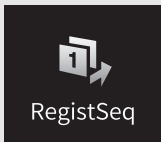

Calling Up Registration Memory Numbers in Order (Registration Sequence)

For changing the panel setup quickly during a live performance, this instrument features the Registration Sequence which lets you call up the eight setups in any order you specify, by simply using the ASSIGNABLE buttons or the pedal as you play.

- 1 On the Home display, touch [▶] at the upper right corner to show the Registration area, then touch the area to call up the Registration Bank Selection display.

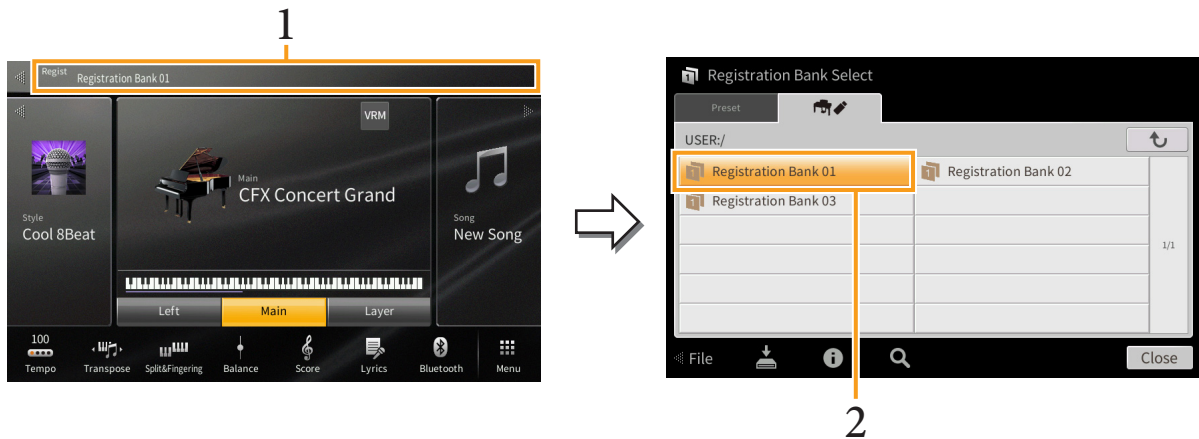

- 2 Select the desired Registration Memory Bank to create a sequence.
- 3 Call up the Registration Sequence display via [Menu] → [RegistSeq].

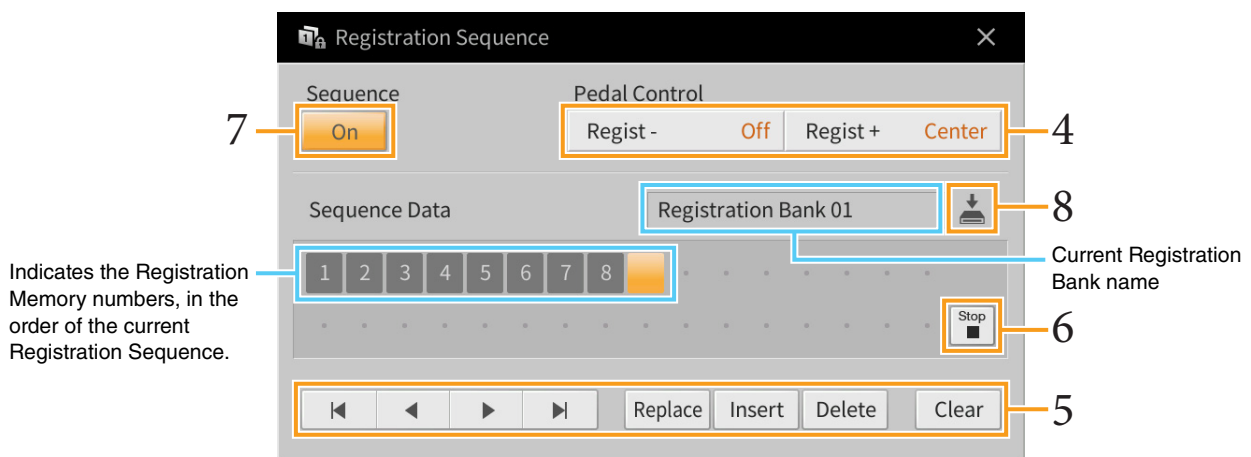

- 4 Specify how the pedal or ASSIGNABLE button will be used.
If you intend to use a pedal to switch the Registration Memory number, the pedal assigned to “Regist +” will be used for advancing through the sequence. The pedal assigned to “Regist -” will be used for reversing through the sequence.

NOTE You can also assign the other functions to the pedal — Punch In/Out of Song (page 89) and the function set in the Assignable display (page 43). If you assign multiple functions to the pedal, the priority is: Punch In/Out of Song → Registration Sequence → the function set in the Assignable display.

If you intend to use the ASSIGNABLE button to switch the Registration Memory number, assign “Regist +” or “Regist -” in the display called up via [Menu] → [Assignable] → [Assignable] (page 46).

- 5 Program a Sequence order in which the Registration Memory number is to be called up.**
 Basically, press the desired Registration Memory number button on the panel, then touch [Insert] to enter the selected number.

◀, ◀, ▶, ▶	Moves the cursor. NOTE If you want to move the cursor directly to an already entered number, touch the desired number.
Replace	Replaces the number of the cursor location with the currently selected Registration Memory number.
Insert	Inserts the number of the currently selected Registration Memory number before the cursor position.
Delete	Deletes the number at the cursor position.
Clear	Deletes all numbers in the sequence.

6 Select the action that will result when the Registration Sequence reaches the end.

- **Stop:** Pressing the ASSIGNABLE button or the “advance” pedal has no effect. The sequence is “stopped.”
- **Top:** The sequence starts again at the beginning.
- **Next:** The sequence automatically moves to the beginning of the next Registration Memory Bank in the same folder.

7 Set the Registration Sequence to “On.”

The Registration Sequence programmed here is shown in the Registration area of the Home display. Press the pedal or the ASSIGNABLE button to check whether or not the Registration Memory number is called up in the order as programmed.

8 Touch  (Save) to call up the File Selection display, then save the sequence program as a Registration Memory Bank file.

NOTICE

Settings in the Registration Sequence display will be lost if you select another Registration Bank without executing the Save operation.

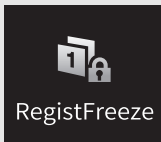

Disabling Recall of Specific Items (Registration Freeze)

Registration Memory lets you recall all the panel setups you made with a single button press. However, there may be times that you want certain items to remain the same, even when switching Registration Memory setups. For example, you may want to switch Voice settings while keeping the same Style. This is where the Freeze function comes in handy. It lets you maintain the settings of certain items and leave them unchanged, even when selecting other Registration Memory buttons.

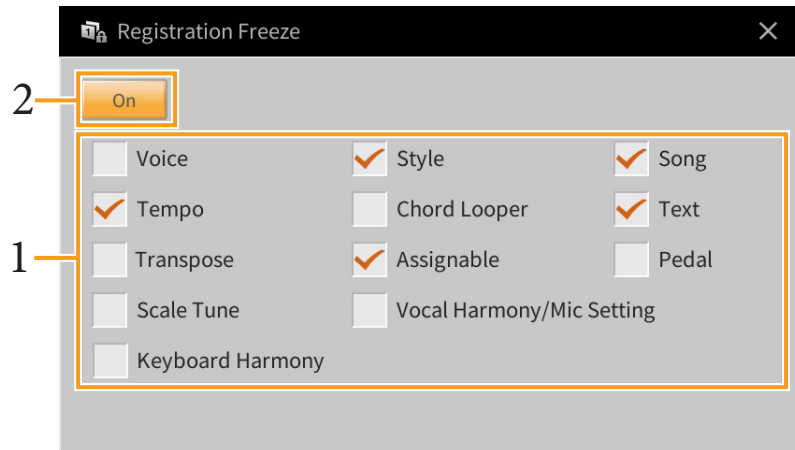

- 1** Enter the checkmark of the item to be “frozen.”
- 2** Set the Registration Freeze to “On.”

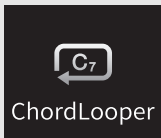

Playing Styles Automatically with Your Custom Chord Progressions (Chord Looper)

Normally, while playing along with a Style, you play chords in the chord section of the keyboard. However, by using the Chord Looper function, you can record chord progressions you want to play over, and the Style can be played back in a loop responding to the chord progression data. For example, if you play the chords C, F, G and C in order and record it, the Style loops and keeps playing back as “C / F / G / C → C / F / G / C ...” —without the need for you to play chords in the chord section of the keyboard. This extends your performance capability, letting you play freely with both your left and right hands.

Playing while using Chord Looper

- 1 Select the desired Style.**
As necessary, adjust the tempo.
- 2 Call up the Chord Looper display.**
- 3 While playing back a Style, touch [Rec/Stop] on the display.**
[Rec/Stop] flashes to indicate recording is in standby. On the next measure of the Style, [Rec/Stop] is turned on and the recording starts.

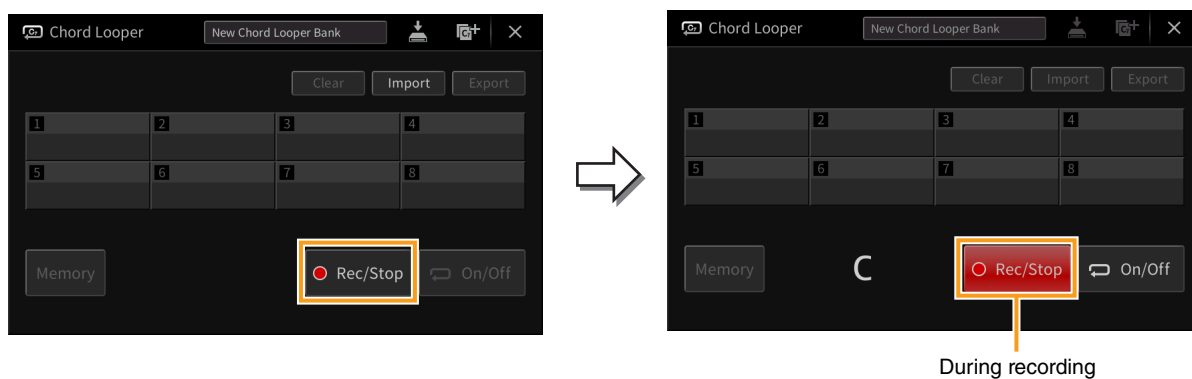

NOTE When [Rec/Stop] is turned on, the [ACMP] button is turned on automatically.

NOTE If you turn on [Rec/Stop] while the Style is stopped, the [SYNC START] button is turned on automatically and lets you start recording when you play a chord in the chord section.

- 4 Play the chords in the chord section, according to the playback tempo of the Style.**

5 At the timing just before the measure you want to start loop playback, touch [On/Off] to stop recording.

[On/Off] flashes to indicate loop playback is in standby. On the next measure of the Style, [On/Off] is turned on and the Style will be played back in a loop in response to the recorded chord progression.

During loop playback, [On/Off] lights and the [ACMP] button flashes. At this time, chord input in the chord section is not detected, and the whole keyboard can be used for performance.

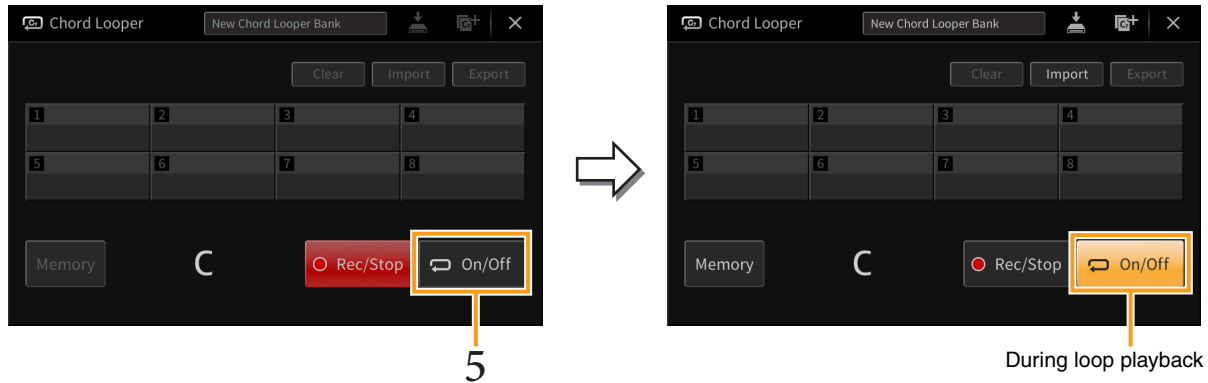

6 Touch [On/Off] to stop loop playback of the Style, and you can play back the Style normally by playing chords in the chord section.

Turning on [On/Off] starts loop playback again in response to the chord progressions recorded in steps 3–5.

NOTE The latest chord progression data you recorded is maintained unless you turn the power off or select a Chord Looper Memory number which contains data. If you want to save the data, go on to step 2 on [page 40](#).

Saving the Recorded Data as a Bank File

The recorded chord progression data can be memorized to the Chord Looper Memory locations [1] – [8], and these eight patterns of data can be saved as a single Chord Looper Bank file.

NOTE The Chord Looper Memory can also be saved (or exported) in single, individual patterns ([page 42](#)).

1 Record the desired chord progressions (steps 1 – 5 on [page 38](#)).

You can stop recording also by turning [Rec/Stop] off or pressing the STYLE CONTROL [▶/■] (START/STOP) button, instead of touching [On/Off].

NOTICE

If you select a Chord Looper Memory number which contains the memorized data or turn off the power to the instrument before going to the next step, the chord progression data you've recorded will be lost.

2 Confirm the data has been recorded, and then touch [Memory].

If the recorded data exists, the letters of [On/Off] at the right bottom of the display are shown in white.

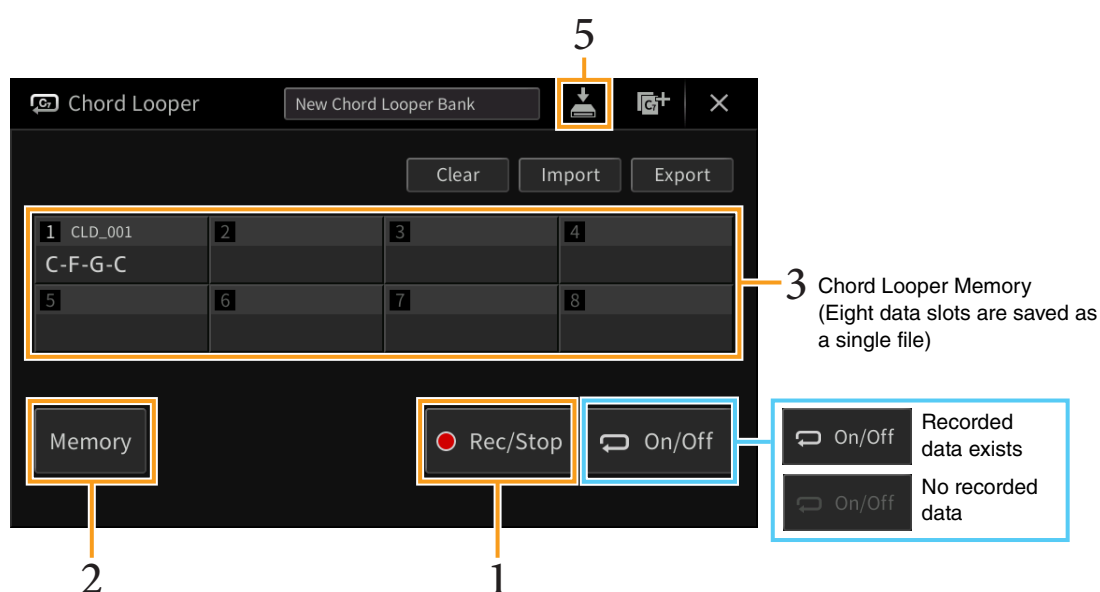

3 Touch the desired Chord Looper Memory number ([1] – [8]) to memorize the chord progression data.

When the data is memorized, the chord progression is shown in the cell of the selected number. If there is not enough space to show all the chords, some chords are omitted.

4 As necessary, repeat steps 1 – 3.

5 Touch (Save) to save the data in the Chord Looper Memory [1] – [8] as a single Bank file.

NOTICE

If you select another Chord Looper Bank file or turn off the power to the instrument before saving the file, the memorized data will be lost.

NOTE Each Chord Looper Memory is named automatically such as "CLD_001," but it can be renamed by exporting the file ([page 42](#)).

Recalling a Chord Looper Bank File and Playing back a Style in a Loop

- 1 Touch the Chord Looper Bank name to call up the Chord Looper Bank Selection display, and select the desired Bank.

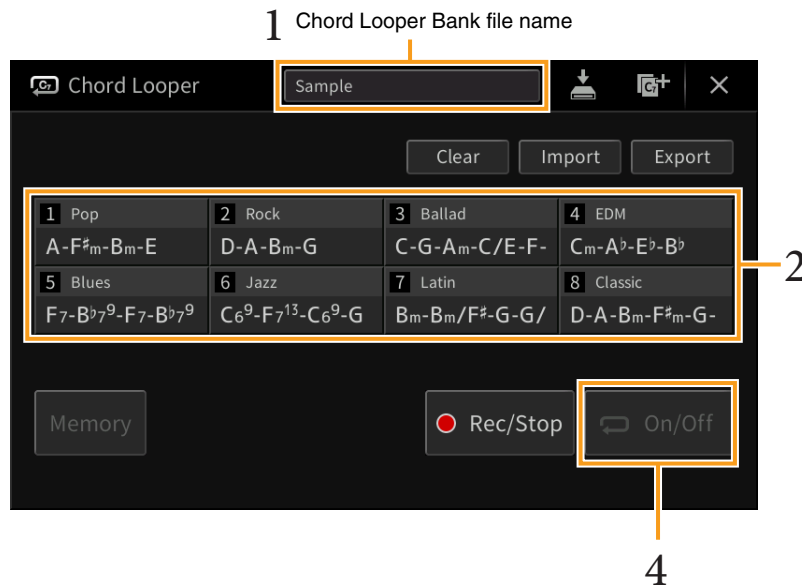

- 2 Touch the Chord Looper Memory number you wish to use first.
If you want to start loop playback of the Style from the beginning of your performance, touch and turn on [On/Off].
- 3 Start playback of the Style and play along with it.
- 4 Turn on [On/Off] just before the measure you want to start loop playback of the Style.
[On/Off] flashes to indicate loop playback is in standby. On the next measure of the Style, [On/Off] is turned on and the Style will be played back in a loop.
During loop playback, [On/Off] lights and the [ACMP] button flashes. At this time, chord input in the chord section is not detected, and the whole keyboard can be used for performance.
- 5 As necessary, change the Chord Looper Memory number or turn loop playback on/off by touching [On/Off].

Editing the Chord Looper Bank file

Each Chord Looper Memory number can be deleted, saved, or recalled one by one. Eight Chord Looper Memories (progressions) can be saved as a single Bank file.

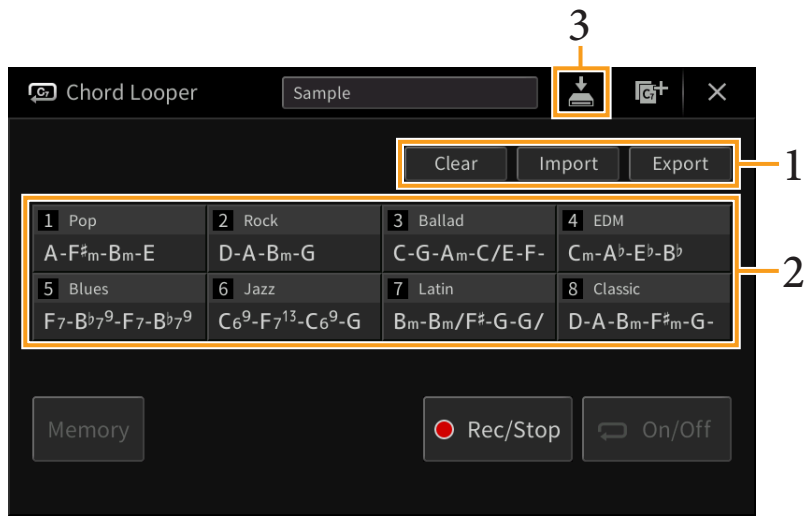

1 Touch the desired action.

Clear	Deletes the data in the specified Chord Looper Memory number.
Import	Imports the Chord Looper Memory data saved (or exported) to User memory or USB flash drive to the specified Chord Looper Memory number.
Export	Saves the data in the specified Chord Looper Memory number to User memory or USB flash drive. The file name is entered automatically, but you can rename it when saving.

2 Touch the desired Chord Looper Memory number to execute the action.

3 As necessary, touch (Save) to save the edited data as a Chord Looper Bank file.

NOTICE

If you select another Chord Looper Bank file or turn off the power to the instrument before saving the file, the edited data will be lost.

If you want to clear all data shown in the Chord Looper display, touch  (New Bank) to create a new Bank.

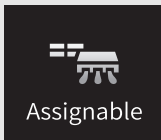

Assigning a Specific Function to Each Pedal or ASSIGNABLE button

Pedal

You can assign various functions to the three pedals of the instrument, instead of the original functions (damper, sostenuto and soft). Likewise, various functions can be assigned to the Footswitch or Foot Controller connected to the [AUX PEDAL] jack.

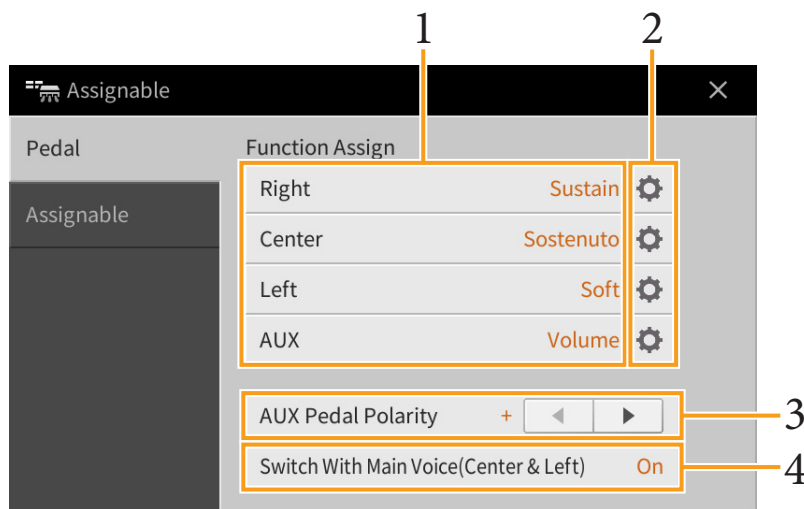

1 Select the function for each pedal.

For information about each function, refer to pages 44 – 45.

NOTE You can also assign other functions to the pedal — Punch In/Out of Song (page 89) and Registration Sequence (page 35). If you assign multiple functions to the pedal, the priority is: Punch In/Out of Song → Registration Sequence → Functions assigned here.

2 Touch (Setting), then make the detailed settings of the selected functions.

For each Part, you can turn on or off the selected function and adjust the degree to which the selected function is applied. Depending on the function selected in Step 1, the available parameters differ, or  (Setting) is grayed out indicating that there is no available parameters.

3 If necessary, set the polarity of the footswitch or foot controller connected to the [AUX PEDAL] jack.

Depending on the Footswitch or Foot Controller, it may work in the opposite way (i.e., pressing it has no effect, but releasing it does). If such a case occurs, use this setting to reverse the polarity.

4 If you change the functions of the Center and Left pedals from the default settings, turn “Switch With Main Voice(Center & Left)” on or off as desired.

When this is set to off, the function assignments of the Center and Left pedals are maintained even if the Main Voice is changed (page 50).

Assignable Pedal Functions

For functions indicated with “*1”, use only the Foot Controller; proper operation cannot be done with a Footswitch.

For functions indicated with “*2”, they can be assigned also to the ASSIGNABLE [1] – [4] buttons.

Articulation 1/2^{*2}	When you use a Super Articulation Voice that has an effect assigned to the pedal/ footswitch, you can enable the effect by pressing the pedal/footswitch.
Volume^{*1}	Controls the volume. This function is available only for the foot controller connected to the instrument’s [AUX PEDAL] jack.
Sustain	Controls the sustain. When you press and hold the pedal, all notes played on the keyboard have a longer sustain. Releasing the pedal immediately stops (damps) any sustained notes. The “Half Pedal Point” parameter allows you to specify how far down you should press on the pedal until the damper effect starts working. This can be set for all pedals on the CVP-809, as well as the right pedal and the foot controller connected to the [AUX PEDAL] jack on the CVP-805.
Sostenuto	Controls the Sostenuto effect. If you play a note or chord on the keyboard and press the pedal while holding the note(s), the notes will sustain as long as the pedal is held. However, all subsequent notes will not sustain. This makes it possible to sustain a chord, for example, while other notes are played staccato. NOTE This function will not affect any of the Organ Flutes and only some of the Super Articulation Voices.
Soft	Controls the Soft effect. Pressing this pedal reduces the volume and changes the timbre of the notes you play. This is effective only for certain appropriate Voices. The “Half Pedal Point” parameter allows you to specify how far down you should press on the pedal until the soft effect starts working. This can be set for all pedals on the CVP-809, as well as the right pedal and the foot controller connected to the [AUX PEDAL] jack on the CVP-805.
Glide	When the pedal is pressed, the pitch changes, and then returns to normal pitch when the pedal is released. <ul style="list-style-type: none"> • Up/Down: Determines whether the pitch change goes up (is raised) or down (is lowered). • Range: Determines the range of the pitch change, in semitones. • On Speed: Determines the speed of the pitch change when the pedal is pressed. • Off Speed: Determines the speed of the pitch change when the pedal is released.
Portamento	The portamento effect (a smooth slide between notes) can be produced while the pedal is pressed. Portamento is produced when notes are played legato style (i.e., a note is played while the preceding note is still held). The portamento time can also be adjusted from the Voice Edit display (page 48). This function does not affect certain Natural Voices, which would not sound appropriately with this function. NOTE This function will not affect any of the Organ Flutes, Super Articulation 2 Voices (CVP-809 only) and only some of the Super Articulation Voices.
Pitch Bend^{*1}	Allows you to bend the pitch of notes up or down by using the pedal. This function can be assigned to all pedals on the CVP-809, as well as the right pedal and the foot controller connected to the [AUX PEDAL] jack on the CVP-805. <ul style="list-style-type: none"> • Up/Down: Determines whether the pitch change goes up (is raised) or down (is lowered). • Range: Determines the range of the pitch change, in semitones.
Modulation +/-^{*1}	Applies a vibrato effect to notes played on the keyboard. Moreover, various effects can be added to the Super Articulation Voice. The effect becomes deeper when pressing down the foot controller.
Modulation (Alt) +/-	Unlike the Modulation above, pressing the pedal or footswitch alternates the on/off status of the vibrato effect.
Vibe Rotor On/Off^{*2}	Switches the Vibe Rotor on and off when the Insertion Effect Type (page 50) is set to “VibeRotor” in the “Legacy” category.

Organ Rotary Slow/ Fast ^{*2}	Switches the Rotary Speaker speed (page 51) between “Slow” and “Fast.”
Keyboard Harmony On/ Off ^{*2}	Switches the Keyboard Harmony (page 24) function on and off.
Vocal Harmony On/Off ^{*2}	Switches “Harmony” in the Vocal Harmony display on and off (page 29).
Vocal Harmony Effect On/Off ^{*2}	Switches “Effect” in the Vocal Harmony display on and off (page 31).
Talk On/Off ^{*2}	Switches between “Vocal” and “Talk” in the Microphone Setting display (page 26).
Score Page +/- ^{*2}	While the Song is stopped, you can turn to the next/previous score page (one page at a time).
Lyrics Page +/- ^{*2}	While the Song is stopped, you can turn to the next/previous lyrics page (one page at a time).
Text Page +/- ^{*2}	You can turn to the next/previous text page (one page at a time).
Song Play/Pause	Same as the SONG CONTROL [▶/■] (PLAY/PAUSE) button.
Style Start/Stop	Same as the STYLE CONTROL [▶/■] (START/STOP) button.
Tap Tempo	Same as the [TAP TEMPO] button.
Synchro Start	Same as the [SYNC START] button.
Synchro Stop	Same as the [SYNC STOP] button.
Intro 1 – 3	Same as the INTRO [I] – [III] buttons.
Main A – D	Same as the MAIN VARIATION [A] – [D] buttons
Fill Down	Plays a fill-in, which is automatically followed by the Main section of the button on the immediate left.
Fill Self	Plays a fill-in.
Fill Break	Plays a break.
Fill Up	Plays a fill-in, which is automatically followed by the Main section of the button on the immediate right.
Ending 1 – 3	Same as the ENDING/rit. [I] – [III] buttons.
Half Bar Fill In	While the pedal is pressed, the “Half bar fill-in” function is turned on and changing sections of a Style at the first beat of the current section starts the next section from the middle with automatic fill-in.
Fade In/Out ^{*2}	Switches Fade In /Fade Out function on and off.
Fingered/ Fingered On Bass ^{*2}	The pedal alternately switches between the Fingered and On Bass modes (page 6).
Bass Hold	While the pedal is pressed, the Style bass note will be held even if the chord is changed during Style playback. If the fingering is set to “AI Full Keyboard,” the function does not work.
Percussion	The pedal plays a percussion instrument selected in the window called up via  (Setting). In this window, you can use the keyboard to select an instrument. NOTE When you select the percussion instrument by pressing a key on the keyboard, the velocity with which you press the key determines the percussion volume.
Main Voice On/Off ^{*2}	Turns the Main Voice on or off.
Layer Voice On/Off ^{*2}	Turns the Layer Voice on or off.
Left Voice On/Off ^{*2}	Turns the Left Voice on or off.
OTS +/-	Calls up the next/previous One Touch Setting.

Assignable

You can assign a specific function to each of the ASSIGNABLE [1] – [4] buttons, letting you call up often used functions quickly. Likewise, you can also assign each of the icons shown in the Menu display to each of these buttons.

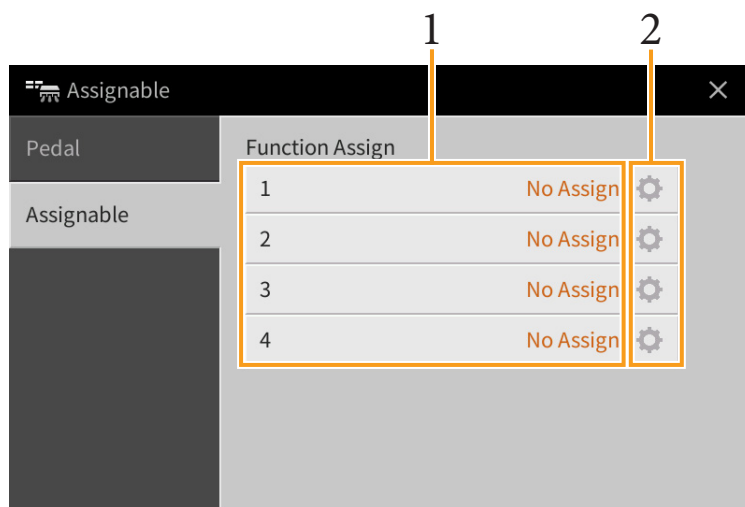

1 Select the item for each of ASSIGNABLE buttons.

You can assign the icons shown in the Menu display (with the exception of Assignable, Wireless LAN, Time and Bluetooth), Pedal Functions marked with “*2” (page 44), and the following functions. If you want no function to be assigned, select “No Assign.”

Left Hold On/Off	Turns on or off the Left Hold.
Effect On/Off	Turns on or off the Effects.
Mono/Poly	Switches between the Mono (in which the Keyboard Voice is played monophonically with the last note priority) and Poly (in which the Keyboard Voice is played polyphonically). Depending on the Voice, Portamento may be produced when notes are played with legato.
Regist +/-	Calls up the next/previous Registration Memory number of the Registration Sequence.

2 If necessary, touch (Setting) then make the detailed settings.

You can turn on or off the specified function for each Part. Depending on the selected function,  (Setting) is grayed out, indicating that there are no available parameters.

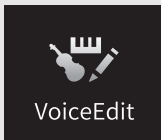

Editing a Voice (Voice Edit)

The Voice Edit feature allows you to create your own Voices by editing some parameters of the existing Voice. Once you've created a Voice, you can save it as a User Voice for future recall. This section covers the editing of Voices other than Organ Flutes Voices, since the method of editing is different between them. For instructions on editing Organ Flutes Voices, refer to [page 51](#).

- 1 Select the desired Voice (other than an Organ Flutes Voice).**
- 2 On the Voice Edit display called up via [Menu] → [VoiceEdit], select the desired parameter then edit the value.**

For information about the editable parameters, refer to [page 48](#).

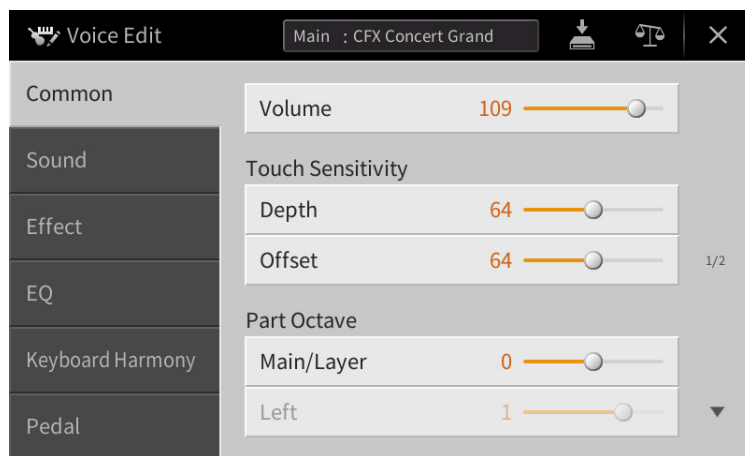

By touching (Compare) repeatedly, you can compare the sound of the edited Voice with the original (unedited) Voice.

- 3 Touch (Save) to save the edited Voice.**

NOTICE

The settings will be lost if you select another Voice or turn the power to the instrument off without executing the Save operation.

NOTE If you want to edit another Voice, touch the Voice name at the top of the Voice Edit display. Or, press the VOICE [MAIN/LAYER/LEFT] button to select the Keyboard part to which the desired Voice is assigned, confirm the Voice name at the top of the Voice Edit display, make the edits as desired, then execute the Save operation.

Editable Parameters in the Voice Edit display

Common

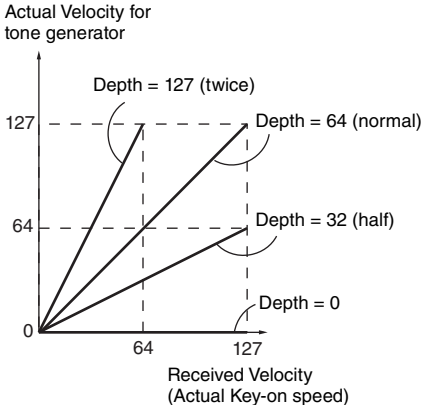
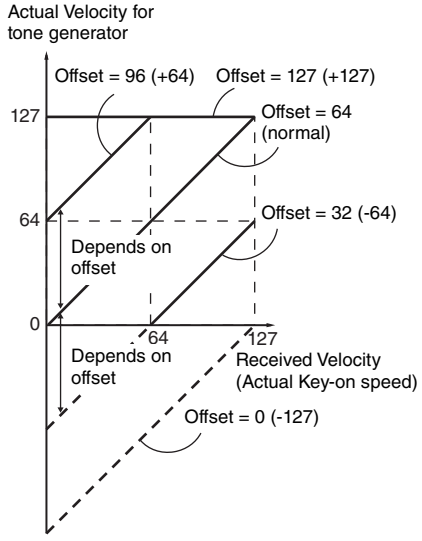
Volume		Adjusts the volume of the current edited Voice.
Touch Sensitivity	Depth	<p>Adjusts the touch sensitivity (velocity sensitivity), or how greatly the volume responds to your playing strength.</p> <p>Touch Sensitivity Depth Changes the velocity curve according to Velocity Depth (with Offset set to 64)</p>  <p>Touch Sensitivity Offset Changes to velocity curve according to Velocity Offset (with Depth set to 64)</p>  <ul style="list-style-type: none"> • Depth: Determines the velocity sensitivity, or how much the level of the Voice changes in response to your playing strength (velocity). • Offset: Determines the amount by which received velocities are adjusted for the actual velocity effect.
	Offset	
Part Octave	Main/Layer	Shifts the octave range of the edited Voice up or down in octaves. When the edited Voice is used as any of the Main and Layer parts, the Main/Layer parameter is available; when the edited Voice is used as the Left part, the Left parameter is available.
	Left	
Mono	Mono/Poly	Determines whether the edited Voice is played monophonically or polyphonically.
	Mono Type	<p>Determines the behavior of the notes of decaying sounds, such as a guitar, when they are played with legato with the edited Voice set to “Mono” above.</p> <ul style="list-style-type: none"> • Normal: The next note sounds after the previous note is stopped. • Legato: The sound of the previously played note is maintained and only the pitch changes to that of the next note. • Crossfade: The sound smoothly transitions from the previously played note to the next note. <p>NOTE This parameter is unavailable for Super Articulation Voices, Drum/SFX Kit Voices and Organ Flutes Voices, and behaves the same as the “Normal” setting when these Voices are selected.</p> <p>NOTE When Legato is selected, the behavior (other than what is described here) may be different from Normal, depending on the panel settings.</p>
	Portamento Time	<p>Sets the portamento time (pitch transition time) when the edited Voice is set to “Mono” above.</p> <p>NOTE The Portamento Time determines the pitch transition time. Portamento is a function that creates a smooth transition in pitch from the first note played on the keyboard to the next.</p>

Sound

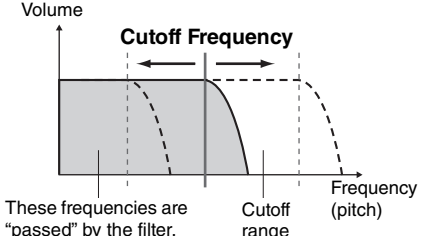
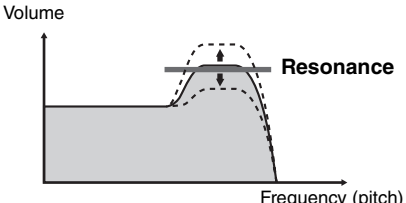
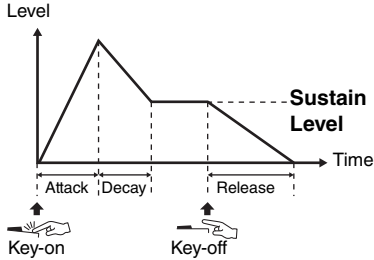
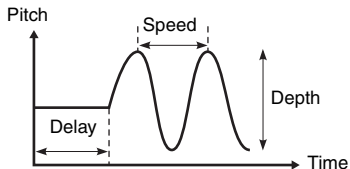
<p>Filter</p>	<p>Filter is a processor that changes the timbre or tone of a sound by either blocking or passing a specific frequency range. The parameters below determine the overall timbre of the sound by boosting or cutting a certain frequency range. In addition to making the sound either brighter or mellower, Filter can be used to produce electronic, synthesizer-like effects.</p>
<p>Brightness</p>	<p>Determines the cutoff frequency or effective frequency range of the filter (see diagram). Higher values result in a brighter sound.</p>  <p>The diagram shows a graph of Volume vs. Frequency (pitch). A solid line represents the filter's response, which is flat at a certain volume level and then drops off. A dashed line shows a higher cutoff frequency, resulting in a brighter sound. A horizontal double-headed arrow indicates the 'Cutoff range'. Below the graph, text states: 'These frequencies are "passed" by the filter.'</p>
<p>Harmonic Cont. (Harmonic Content)</p>	<p>Determines the emphasis given to the cutoff frequency (resonance), set in Brightness above (see diagram). Higher values result in a more pronounced effect.</p>  <p>The diagram shows a graph of Volume vs. Frequency (pitch). A solid line shows a filter response with a peak at the cutoff frequency. A dashed line shows a higher peak, labeled 'Resonance', indicating a more pronounced effect.</p>
<p>EG</p>	<p>The EG (Envelope Generator) settings determine how the level of the sound changes in time. This lets you reproduce many sound characteristics of natural acoustic instruments — such as the quick attack and decay of percussion sounds, or the long release of a sustained piano tone.</p>  <p>The diagram shows a graph of Level vs. Time. The curve starts at the origin, rises linearly through the 'Attack' phase, levels off at the 'Sustain Level' during the 'Decay' phase, and then falls linearly through the 'Release' phase. 'Key-on' is marked at the start of the attack, and 'Key-off' is marked at the end of the release.</p>
<p>Attack</p>	<p>Determines how quickly the sound reaches its maximum level after the key is played. The lower the value, the quicker the attack.</p>
<p>Decay</p>	<p>Determines how quickly the sound reaches its sustain level (a slightly lower level than maximum). The lower the value, the quicker the decay.</p>
<p>Release</p>	<p>Determines how quickly the sound decays to silence after the key is released. The lower the value, the quicker the decay.</p>
<p>Vibrato</p>	<p>Vibrato is a quavering, vibrating sound effect that is produced by regularly modulating the pitch of the Voice.</p>  <p>The diagram shows a graph of Pitch vs. Time. A wavy line represents the pitch modulation. 'Delay' is the time from key-on to the start of the vibrato. 'Speed' is the time for one full cycle of the wave. 'Depth' is the vertical distance from the average pitch to the peak of the wave.</p>
<p>Depth</p>	<p>Determines the intensity of the Vibrato effect. Higher settings result in a more pronounced Vibrato.</p>
<p>Speed</p>	<p>Determines the speed of the Vibrato effect.</p>
<p>Delay</p>	<p>Determines the amount of time that elapses between the playing of a key and the start of the Vibrato effect. Higher settings increase the delay of the Vibrato onset.</p>
<p>Modulation (+)/(-)</p>	<p>When the Modulation function is assigned to a pedal (page 44), the pedal can be used to modulate the parameters below as well as the pitch (vibrato). Here, you can set the degree to which the pedal modulates each of the following parameters.</p> <p>Filter</p> <p>Determines the degree to which the pedal modulates the Filter Cutoff Frequency. For details about the filter, refer to page 49.</p>

Modulation (+)/(-)	Amplitude	Determines the degree to which the pedal modulates the amplitude (volume).
	LFO Pitch	Determines the degree to which the pedal modulates the pitch, or the vibrato effect.
	LFO Filter	Determines the degree to which the pedal modulates the Filter cutoff frequency, or the wah effect.
	LFO Amplitude	Determines the degree to which the pedal modulates the amplitude, or the tremolo effect.

Effect

Insertion Effect	On/Off	Turns the Insertion Effects on or off.
	Type	Selects the Insertion Effect Type. Select the Category then select the Type. You can adjust the detailed parameters by touching  (Setting) and save them. Refer to “Editing and Saving the Effect settings” (page 13) for details.
	Depth	Adjusts the Insertion Effect Depth.
	Vibe Rotor	Available only if “VibeRotor” in the “Legacy” category is selected as the Insertion Effect Type explained above. Determines whether Vibe Rotor should be set to on or off when selecting the Voice.
Reverb*	Depth	Adjusts the Reverb Depth.
Chorus*	Depth	Adjusts the Chorus Depth.

*Reverb and Chorus depth cannot be edited when a VRM Voice is selected, but can be edited via [Menu] → [VoiceSetting] → [Piano] (page 1/2). For details, refer to [page 79](#).

EQ

Determines the Frequency and Gain of the EQ bands. For information about EQ, refer to [page 11](#).

Keyboard Harmony

From this display, you can set the same parameters as those in the Keyboard Harmony display (step 2 on [page 24](#)). Before making any settings, make sure that the current part is set to Main; in other words, you should select the Main part by touching the Voice name at the top of the Voice Edit display, or by pressing the VOICE [MAIN/LAYER/LEFT] button. The settings here are called up automatically simply by selecting the corresponding Voice.

Pedal

This section allows you to select the function to be assigned to the center or left pedal. Before making any settings, make sure that the current part is set to Main; in other words, you should select the Main part by touching the Voice name at the top of the Voice Edit display, or by pressing the VOICE [MAIN/LAYER/LEFT] button. The settings here are called up automatically simply by selecting the corresponding Voice. For details about the pedal function, refer to [page 44](#).

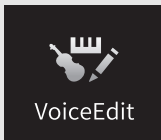

Editing an Organ Flutes Voice (Voice Edit)

The Organ Flute Voices can be edited by adjusting the footage levers, adding the attack sound, applying effect and equalizer, etc.

1 Select the desired Organ Flutes Voice.

From the [Organ] Category, touch [Organ Flutes], then select the desired Organ Flutes Voice.

2 On the Voice Edit display called up via [Menu] → [VoiceEdit], select the desired parameter then edit the value.

NOTE The Voice Edit display for the Organ Flutes Voices can also be called up by touching the Organ Flutes icon at upper right of the Organ Flutes Voice name in the Home display. This is useful for adjusting footage settings and controlling the rotary speaker while you play.

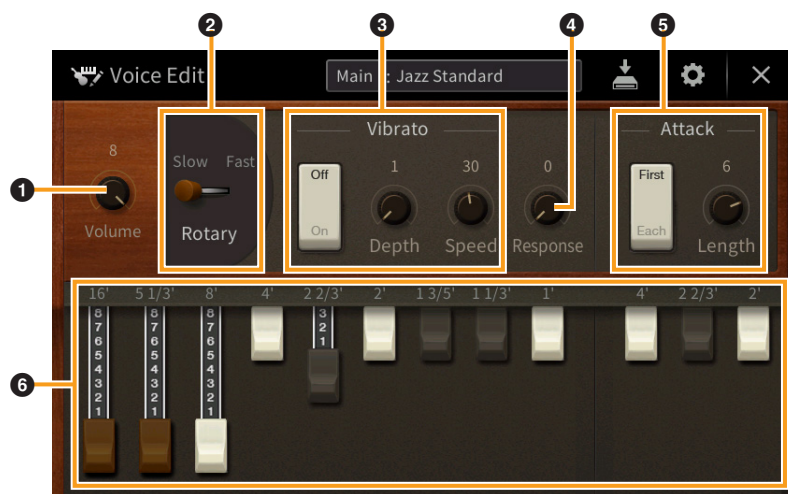

There are three types for Organ Flutes Voices and the parameters indicated by “*” are available only for the Vintage and Home type. For details about the organ types, refer to the Owner’s Manual, Chapter 3.

❶	Volume	Adjusts the overall volume of the Organ Flutes.
❷	Rotary/ Tremolo*	Alternately switches the Rotary Speaker speed between “Slow” and “Fast.” This parameter is available only when an effect (page 12) which contains “Rotary” in its name is applied.
❸	Vibrato*	Turns on or off the vibrato, and adjusts its depth and speed.
❹	Response	Affects both the attack and release (page 49) portion of the sound, increasing or decreasing the response time of the initial swell and release, based on the Footage controls. The higher the value, the slower the swell and release.
❺	Attack	Selects “First” or “Each” as the Attack mode and adjusts the Attack length of the sound. In the First mode, attack (percussive sound) is applied only to the first notes played and held simultaneously; while the first notes are held, any subsequently played notes have no attack applied. In the Each mode, attack is applied equally to all notes. The Attack length produces a longer or shorter decay immediately after the initial attack. The longer the value, the longer the decay time.
❻	Footage	Determines the basic sound of the organ flutes.

- 3** As necessary, touch  (Setting) then set the parameters related to the Effects and EQ. The parameters are same as those in the Effect display and EQ display of the previous chapter “Editing a Voice (Voice Edit)” (page 50).

- 4** Touch  (Save) to save the created Organ Flutes Voice.

NOTICE

The settings will be lost if you select another Voice or turn the power to the instrument off without executing the Save operation.

NOTE If you want to edit another Voice, touch the Voice name at the top of the Voice Edit display. Or, press the VOICE [MAIN/LAYER/LEFT] button to select the Keyboard part to which the desired Voice is assigned, confirm the Voice name at the top of the Voice Edit display, make the edits as desired, then execute the Save operation.

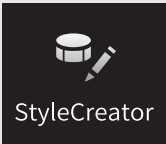

Creating/Editing Styles (Style Creator)

The Style Creator function lets you create an original Style by recording the rhythm pattern via the keyboard performance and using the already-recorded Style data. Basically, select a preset Style that is closest to the type you want to create, then record the rhythm pattern, bass line, chord backing, or phrase (referred to as “Source Pattern” in the Style Creator) for each channel of each Section. Like the Song, two Recording methods are available: Realtime Recording and Step Recording ([page 54](#)).

■ Style Data Structure – Consisting of Source Patterns

A Style is made up of different Sections (Intro, Main, Ending, etc.) and each Section has eight separate channels, each of which is referred to as a “Source Pattern.” With the Style Creator feature, you can create a Style by separately recording the Source Pattern for each channel, or by importing pattern data from other existing Styles.

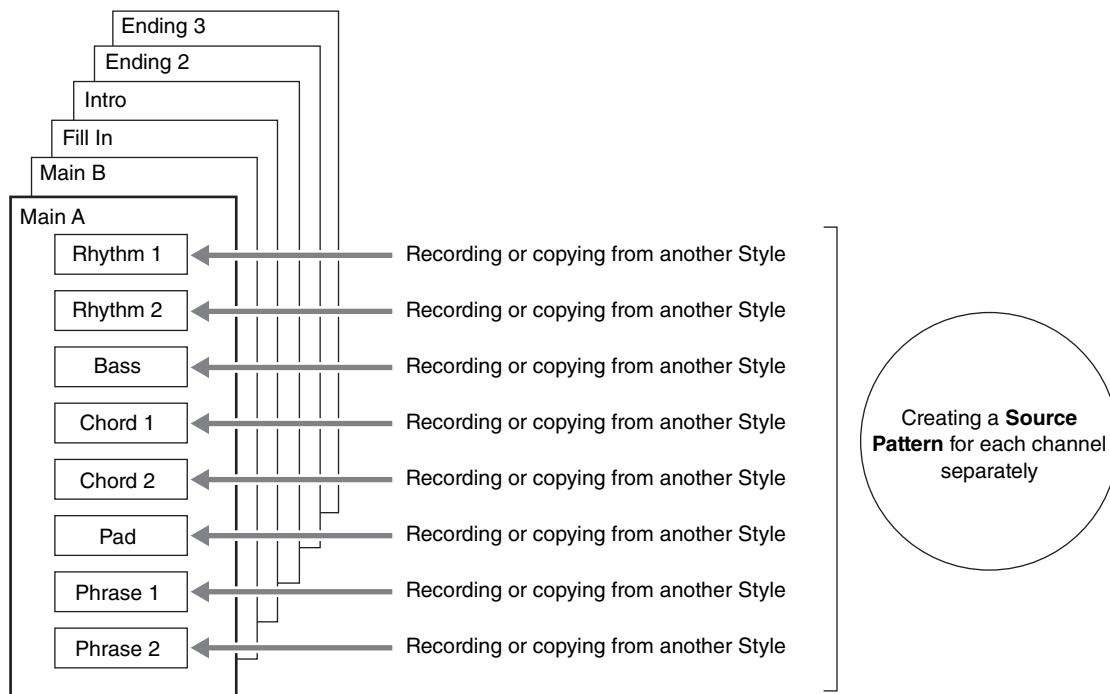

■ Basic Procedure for creating a Style

The detailed instructions are described on the reference page of each step.

1 Select the desired Style as starting data.

2 Call up the Style Creator display via [Menu] → [StyleCreator].

3 On the “Basic” display, select a Section ([page 55](#)).

As necessary, make the following settings.

- If you create a Style entirely from scratch, touch [Initialize Style] to make the current Style empty.
- If you initialize the Style, set the length (measure amount) of the Source Pattern.
- Set the overall parameters such as Tempo and Beat.

4 Create the Source Pattern for each channel.

• Realtime Recording ([page 56](#))

Lets you record the Style by simply playing the keyboard.

• Step Recording ([page 59](#))

Lets you enter each note individually.

• Style Assembly ([page 59](#))

Lets you copy various patterns from other preset Styles or Styles you have already created.

5 Edit the already recorded channel data.

• Channel Edit ([page 60](#))

Lets you edit the MIDI data of the already recorded channels.

• SFF Edit ([page 62](#))

Lets you edit the SFF (Style File Format) related parameters of the already recorded channels other than Rhythm channels.

6 Repeat steps 3 – 5 as desired.

7 Touch (Save) at the top of the display to save the created Style.

Basic

The explanations here apply to step 3 on [page 54](#). This display lets you set the basic parameters such as Section selection.

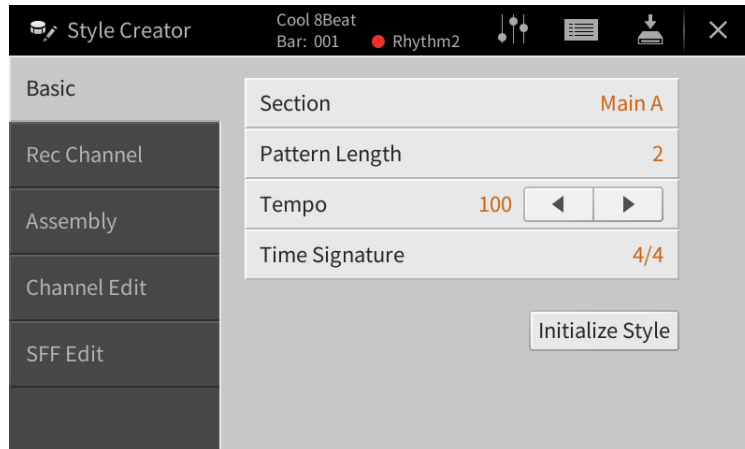

Section	Selects a Section for creating or editing.
Pattern Length	Selects the length (in measures) of the current Section. After inputting the value, touch [Execute] to actually enter the changes.
Tempo	Sets the tempo of the Style. The setting here commonly applies to all Sections.
Beat	Sets the beat of the Style. The setting here commonly applies to all Sections. After inputting the value, touch [Execute] to actually enter the changes.
Initialize Style	Initializes all channel data of all Sections belonging to make the current Style empty. Touch here when you want to create the Style data from scratch.

Realtime Recording

The explanations here apply to step 4 on [page 54](#). In the “Rec Channel” display, you can create the channel data via the Realtime Recording.

Realtime Recording Characteristics in the Style Creator

■ Loop Recording

Style playback repeats the rhythm patterns of several measures in a “loop,” and Style recording is also done using loops. For example, if you start recording with a two-measure Main section, the two measures are repeatedly recorded. Notes that you record will play back from the next repetition (loop), letting you record while hearing previously recorded material.

■ Overdub Recording

This method records new material to a channel already containing recorded data, without deleting the original data. In Style recording, the recorded data is not deleted, except when using functions such as “Clear Drum Inst” ([page 57](#)) “Delete” ([pages 57, 58](#)) and “Remove Event” ([page 61](#)). For example, if you start recording with a two-measure Main section, the two measures are repeated many times. Notes that you record will play back from the next repetition, letting you overdub new material to the loop while hearing previously recorded material. When creating a Style based on an existing internal Style, overdub recording is applied only to the rhythm channels. For all other channels (except rhythm), you need to delete the original data before recording.

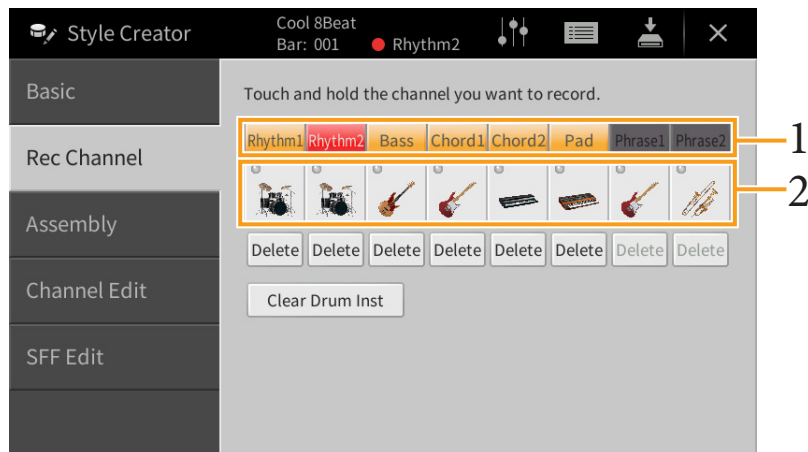

■ Recording Rhythm Channels 1 – 2

1 On the “Rec Channel” display, touch and hold the desired channel until it turns red.

The selected channel becomes the Recording target whether the channel already contains data or not. If recorded data is already included, you should record the additional notes to the selected channel as Overdub Recording.



2 If necessary, select a Voice then practice the rhythm pattern to be recorded.

Touch the instrument icon (illustration) to call up the Voice Selection display then select the desired Voice such as Drum Kit. After selecting, touch [Close] to return to the original display. With the selected Voice, practice the rhythm pattern to be recorded.

Available Voices for recording

For the Rhythm1 channel, any except Organ Flutes Voices can be used for recording.
For the Rhythm2 channel, only Drum/SFX kits can be used for recording.

3 Press the STYLE CONTROL [▶/■](START/STOP) button to start recording.

Since already recorded data plays back, turn each channel on or off by touching as desired. If necessary, delete a channel by touching [Delete] located under the desired channel.

4 As soon as loop playback returns to the first beat in the first measure, start playing the rhythm pattern to be recorded.

If the rhythm is difficult to play all at once, you can break it down into isolated parts, such as in this example:

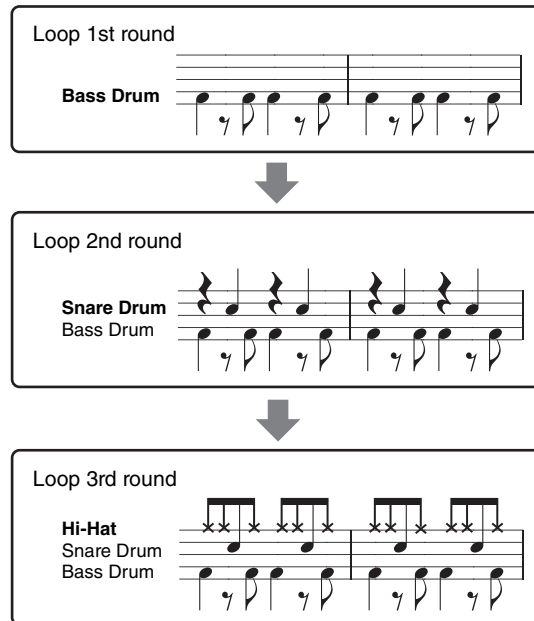

If you make a mistake or play any wrong notes:

You can delete notes of a specific drum instrument. Touch [Clear Drum Inst] to call up a message, then press the corresponding key on the keyboard while the message is shown. After deleting the desired drum instrument, touch [Exit] to close the message.

5 Press the STYLE CONTROL [▶/■](START/STOP) button to stop playback.

If you want to add more notes, press the [▶/■] (START/STOP) button again to continue recording.

6 Touch and hold the Recording channel for a while (until the button changes color) to exit from the Recording mode.

■ Recording Bass, Chord 1 – 2, Pad and Phrase 1 – 2

1 On the “Rec Channel” display, touch and hold the desired channel until it turns red.

If the selected channel already contains data, a confirmation message appears, prompting you whether or not to delete the existing data of the selected channel. Touch [Yes] to delete data and the selected channel is specified as Record target. Note that channel data other than the Rhythm channels of the preset Style cannot be overdubbed.

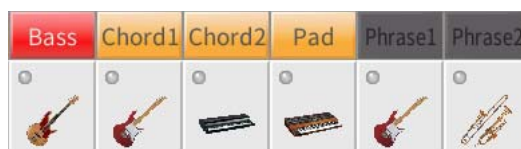

2 If necessary, select a Voice then practice the bass line, chord backing, or phrase to be recorded.

Touch the instrument icon (illustration) to call up the Voice Selection display then select the desired Voice. After selecting, touch [Close] to return to the original display. With the selected Voice, practice the phrase or chord backing to be recorded.

Available Voices for recording

Any except for the Organ Flutes/Drum kit/SFX kit Voices can be used for recording.

■ Record a phrase in CM7 which will play appropriate notes as change chords during performance

Rules when recording a Main or Fill-in

With the default initial settings, the Source Root/Chord is set to CM7. This means that you should record a Source Pattern which is to be triggered by specifying CM7 during normal performance. Record a bass line, phrase or chord backing which you want to hear when CM7 is specified. Specifically, see the rules below.

- Use only the CM7 scale tones when recording the Bass and Phrase channels (i.e., C, D, E, G, A, and B).
- Use only the chord tones when recording the Chord and Pad channels (i.e., C, E, G, and B).



C = Chord note
C, R = Recommended note

If you observe these rules, Style playback notes are appropriately converted depending on the chord changes you make during your performance.

Rules when recording an Intro or Ending

These Sections are designed assuming that the chord is not changed during playback. This is why you need not observe the rules for Main and Fill-In Sections described above, and you can make the chord progression in recording. However, follow the rules below since the Source Root/Chord is set to CM7 by default.

- When recording the Intro, make sure that the recorded phrase leads properly into a C scale.
- When recording the Ending, make sure that the recorded phrase begins with or properly follows a C scale.

■ Setting the Source Root/Chord if necessary

Although the default Source Root/Chord is set to CM7 as described above, you can change this to any desired one in which you can play easily. Call up the “SFF Edit” display, set the Source Root and Chord to the favorite or desired Root and Chord type. Keep in mind that when you change the Source Chord from the default CM7 to another chord, the chord notes and recommended notes will also change. For details, refer to [page 63](#).

3 Press the STYLE CONTROL [▶/■](START/STOP) button to start recording.

With the already recorded data playing back, turn each channel on or off by touching as desired. If necessary, delete a channel by touching [Delete] located under the desired channel.

4 As soon as loop playback returns to the first beat in the first measure, start playing the bass line, chord backing or phrase to be recorded.

5 Press the [▶/■](START/STOP) button to stop playback.

If you want to add more notes, press the [▶/■](START/STOP) button again to continue recording.

■ To hear the playback sound of the already recorded channels with another Source Chord/Root:

- 1) Call up the “SFF Edit” display, then set the “Target Ch” at the top of the display to “Rhythm1” or “Rhythm2.”
- 2) Touch [Play Root/Chord] to call up the operation display.
- 3) Press the STYLE CONTROL [▶/■](START/STOP) button to start playback.
- 4) On the display, set the “Play Root/Chord” to the desired Chord root and Chord type.

This operation lets you hear how the Source Pattern is played back via chord changes during normal performance.

6 Touch and hold the Recording channel for a while (until the button changes color) to exit from the Recording mode.

Step Recording

The explanations here apply to step 4 on [page 54](#). In the Step Recording (Style Edit) display called up by touching  (Edit) at the upper right of the display, you can record or edit notes one by one. This Step Recording procedure is essentially the same as that for Song Recording ([page 67](#)) with the exception of the points listed below:

- In the Song Creator, the “End” mark position can be changed freely; in the Style Creator, it cannot be changed. This is because the length of the Style is fixed for all channels as you set in the “Basic” display ([page 55](#)). For example, if you create a Style of four measures length, the “End” mark position is automatically set to the end of fourth measure, and cannot be changed in the Style Edit display.
- Recording channels can be changed in the Song Creator’s Edit display; however, they cannot be changed in the Style Creator. Select the Recording channel in the “Rec channel” display.
- In the Style Creator, Chord, Lyrics, and System Exclusive data cannot be entered. The Channel data can be entered and System Exclusive data can be edited (delete, copy or move).

Assembly — Assigning the Source Pattern to Each Channel

The explanations here apply to step 4 on [page 54](#). The “Assembly” display shows that each channel data of the current Section has been copied from which Style, which Section, and which channel. For each channel, touch the Style name, Section name, or Channel name in the “Copy From” section as necessary to select the desired one. Assemble the Style while listening to the Style playback by pressing the STYLE CONTROL [▶/■] (START/STOP) button. You can turn each channel on or off by touching the channel button.

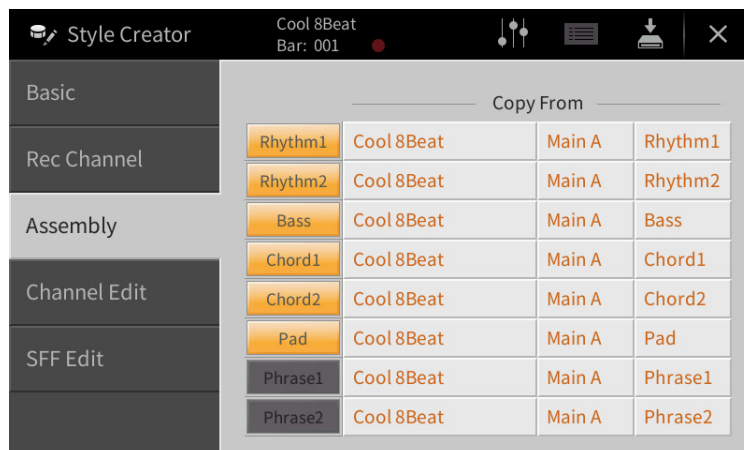

Copy From			
Rhythm1	Cool 8Beat	Main A	Rhythm1
Rhythm2	Cool 8Beat	Main A	Rhythm2
Bass	Cool 8Beat	Main A	Bass
Chord1	Cool 8Beat	Main A	Chord1
Chord2	Cool 8Beat	Main A	Chord2
Pad	Cool 8Beat	Main A	Pad
Phrase1	Cool 8Beat	Main A	Phrase1
Phrase2	Cool 8Beat	Main A	Phrase2



Channel Edit

The explanations here apply to step 5 on [page 54](#). The “Channel Edit” display lets you edit the already recorded channel data. Select the Target channel then edit the desired parameters.

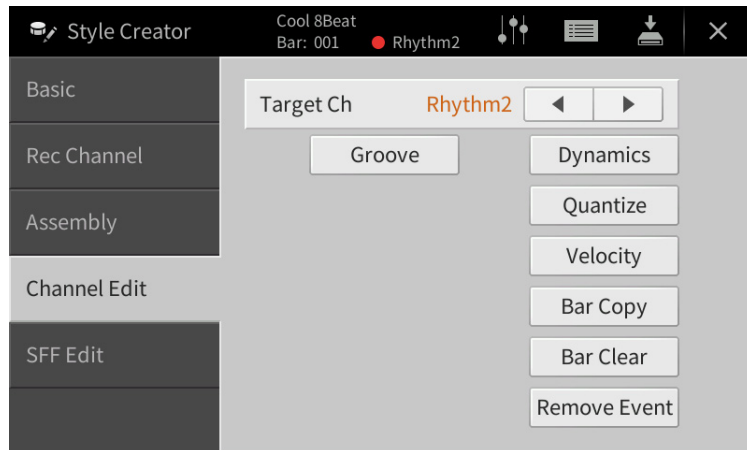
After editing the desired parameter, touch [Execute] to actually enter the edits for each setup window. When execution is completed, this button changes to [Undo], letting you restore the original data if you are not satisfied with the results. The Undo function only has one level; only the previous operation can be undone.



Target Ch	Select the target channel to be edited. All items with the exception of the “Groove” are to be applied to the channel specified here.	
Groove	This lets you add swing to the music or change the “feel” of the beat by making subtle shifts in the timing (clock) of the Style. The Groove settings are applied to all channels of the selected Section.	
	Original Beat	Specifies the beats to which Groove timing is to be applied. In other words, if “8 Beat” is selected, Groove timing is applied to the 8th notes; if “12 Beat” is selected, Groove timing is applied to 8th-note triplets.
	Beat Converter	Actually changes the timing of the beats (specified in the “Original Beat” parameter above) to the selected value. For example, when Original Beat is set to “8 Beat” and Beat Converter is set to “12,” all 8th notes in the section are shifted to 8th-note triplet timing. The “16A” and “16B” Beat Converter which appear when Original Beat is set to “12 Beat” are variations on a basic 16th-note setting.
	Swing	Produces a “swing” feel by shifting the timing of the back beats, depending on the “Original Beat” parameter above. For example, if the specified Original Beat value is “8 Beat”, the Swing parameter will selectively delay the 2nd, 4th, 6th, and 8th beats of each measure to create a swing feel. The settings “A” through “E” produce different degrees of swing, with “A” being the most subtle and “E” being the most pronounced.
	Fine	Selects a variety of Groove “templates” to be applied to the selected section. The “Push” settings cause certain beats to be played early, while “Heavy” settings delay the timing of certain beats. The numbered settings (2, 3, 4, 5) determine which beats are to be affected. All beats up to the specified beat — but not including the first beat — will be played early or delayed (for example, the 2nd and 3rd beats, if “3” is selected). In all cases, “A” types produce minimum effect, “B” types produce medium effect, and “C” types produce maximum effect.

Dynamics	This changes the velocity/volume (or accent) of certain notes in the Style playback. The Dynamics settings can be applied to each channel individually or all channels of the selected Style.	
	Accent Type	Determines the type of accent applied — in other words, which notes are emphasized.
	Strength	Determines how strongly the selected Accent Type (above) will be applied. The higher the value, the stronger the effect.
	Expand/Compress	Expands or compresses the range of velocity values. Values higher than 100% expand the dynamic range, while values lower than 100% compress it.
	Boost/Cut	Boosts or cuts all velocity values. Values above 100% boost the overall velocity, while values below 100% reduce it.
	Apply To All Channels	When set to “On,” the settings in this display will be applied to all the channels of the current Section. When set to “Off,” the settings in this display will be applied to the channel specified at the “Target Ch” in the Channel Edit display.
Quantize	Same as in the Song Creator (page 76), with the exception of the two additional available parameters below.  Eighth notes with swing  Sixteenth notes with swing	
Velocity	Boosts or cuts the velocity of all notes in the specified channel, according to the percentage specified here.	
Bar Copy	This function allows data to be copied from one measure or group of measures to another location within the specified channel.	
	Source Top	Specifies the first (Source Top) and last (Source Last) measures in the region to be copied.
	Source Last	
	Destination	Specifies the first measure of the destination location, to which the data is to be copied.
Bar Clear	This function clears all data from the specified range of measures within the selected channel.	
Remove Event	This function lets you remove specific events from the selected channel.	

SFF Edit — Making Style File Format Settings

The explanations here apply to step 5 on [page 54](#). The Style File Format (SFF) combines all of Yamaha’s Style playback know-how into a single unified format. Setting the SFF related parameters determines how the original notes are converted to the actual sounded notes based on the chord you specify in the Chord area of the keyboard. The conversion flow is shown below.

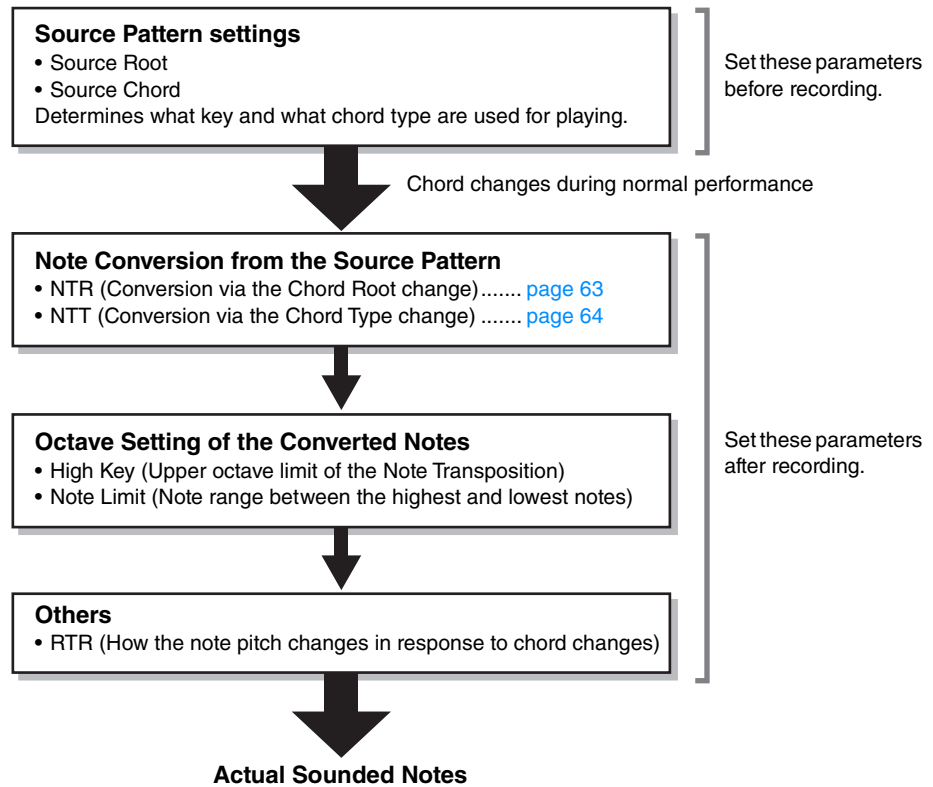

The parameters shown above can be set in the “SFF Edit” display.

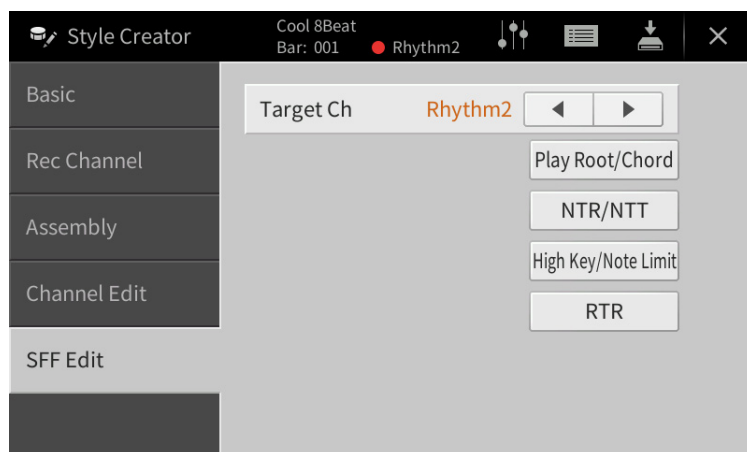

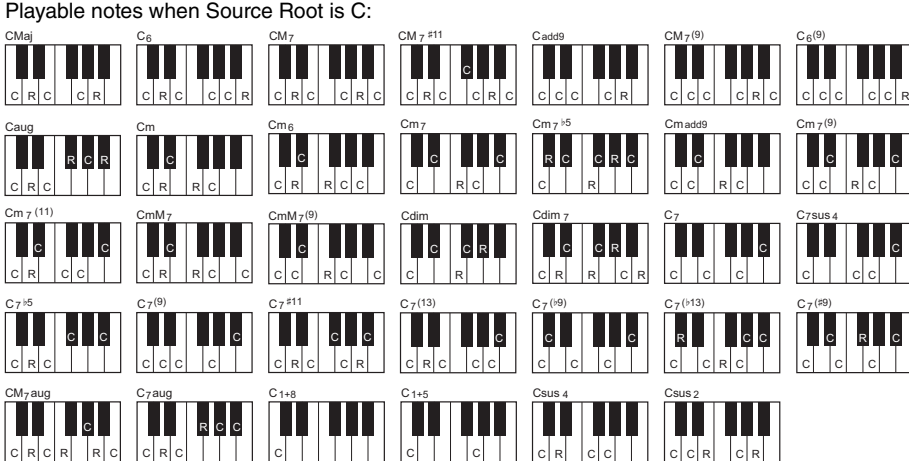
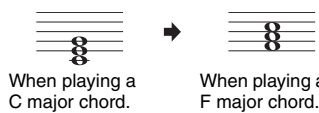
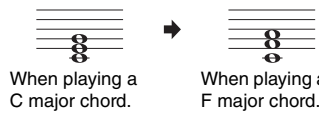
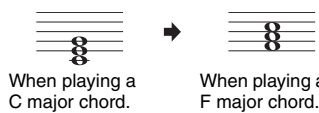
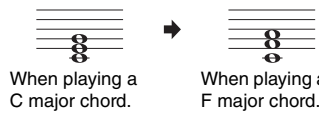
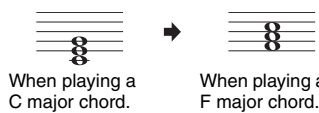
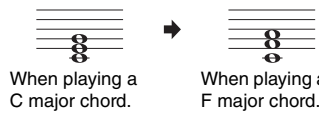
<p>Target Ch</p> <p>Select the target channel to be edited.</p>	<p>Select the target channel to be edited.</p>								
<p>Source Root/Chord (Play Root/Chord)</p>	<p>These settings determine the original key of the Source Pattern (i.e., the key used when recording the pattern to the channel other than the Rhythm channels). If you set “Fm7” here, specifying “Fm7” in the Chord section of the keyboard will play back the originally recorded data (Source Pattern). The default setting is “CM7” (Source Root = C and Source Chord = M7). Depending on the selected chord type specified here, the playable notes (scale notes and chord notes) differ. When “Initialize Style” is executed in the “Basic” display, the default setting of CM7 is automatically selected.</p> <p>Playable notes when Source Root is C:</p>  <p>C = Chord notes C, R = Recommended notes</p> <p>IMPORTANT Make sure to set the parameters here before recording. If you change the settings after recording, the recorded Source Pattern cannot be converted to the appropriate notes when changing the chord during your keyboard performance.</p> <p>NOTE When the parameters for the selected Target Ch are set to NTR: Root Fixed, NTT Type: Bypass, or NTT Bass: Off, the parameters here are changed to “Play Root” and “Play Chord,” respectively. In this case, you can change chords and hear the resulting sound for all channels.</p> <p>NOTE The settings here are not applied when NTR is set to “Guitar.”</p>								
<p>NTR/NTT (Note Transposition Rule/Note Transposition Table)</p>	<p>The parameters here determine how the notes in the Source Pattern are converted according to the chord changes during your keyboard performance.</p> <table border="1" data-bbox="470 1332 1444 2049"> <tr> <td data-bbox="470 1332 646 1422"> <p>NTR</p> </td> <td data-bbox="646 1332 1444 1422"> <p>Selects the Note Transposition Rule which determines how the notes in the Source Pattern are transposed according to the Chord Root change.</p> </td> </tr> <tr> <td data-bbox="470 1422 646 1691"> <p>Root Trans</p> </td> <td data-bbox="646 1422 1444 1691"> <p>When the root note is transposed, the interval between notes is maintained. For example, the notes C3, E3 and G3 in the key of C become F3, A3 and C4 when they are transposed to F. Use this setting for channels that contain melody lines.</p>  <p>When playing a C major chord. When playing an F major chord.</p> </td> </tr> <tr> <td data-bbox="470 1691 646 1937"> <p>Root Fixed</p> </td> <td data-bbox="646 1691 1444 1937"> <p>The note is kept as close as possible to the previous note range. For example, the notes C3, E3 and G3 in the key of C become C3, F3 and A3 when they are transposed to F. Use this setting for channels that contain chord parts.</p>  <p>When playing a C major chord. When playing an F major chord.</p> </td> </tr> <tr> <td data-bbox="470 1937 646 2049"> <p>Guitar</p> </td> <td data-bbox="646 1937 1444 2049"> <p>This is exclusively for transposing guitar accompaniment. Notes are transposed to approximate the chords played with natural guitar fingering.</p> </td> </tr> </table>	<p>NTR</p>	<p>Selects the Note Transposition Rule which determines how the notes in the Source Pattern are transposed according to the Chord Root change.</p>	<p>Root Trans</p>	<p>When the root note is transposed, the interval between notes is maintained. For example, the notes C3, E3 and G3 in the key of C become F3, A3 and C4 when they are transposed to F. Use this setting for channels that contain melody lines.</p>  <p>When playing a C major chord. When playing an F major chord.</p>	<p>Root Fixed</p>	<p>The note is kept as close as possible to the previous note range. For example, the notes C3, E3 and G3 in the key of C become C3, F3 and A3 when they are transposed to F. Use this setting for channels that contain chord parts.</p>  <p>When playing a C major chord. When playing an F major chord.</p>	<p>Guitar</p>	<p>This is exclusively for transposing guitar accompaniment. Notes are transposed to approximate the chords played with natural guitar fingering.</p>
<p>NTR</p>	<p>Selects the Note Transposition Rule which determines how the notes in the Source Pattern are transposed according to the Chord Root change.</p>								
<p>Root Trans</p>	<p>When the root note is transposed, the interval between notes is maintained. For example, the notes C3, E3 and G3 in the key of C become F3, A3 and C4 when they are transposed to F. Use this setting for channels that contain melody lines.</p>  <p>When playing a C major chord. When playing an F major chord.</p>								
<p>Root Fixed</p>	<p>The note is kept as close as possible to the previous note range. For example, the notes C3, E3 and G3 in the key of C become C3, F3 and A3 when they are transposed to F. Use this setting for channels that contain chord parts.</p>  <p>When playing a C major chord. When playing an F major chord.</p>								
<p>Guitar</p>	<p>This is exclusively for transposing guitar accompaniment. Notes are transposed to approximate the chords played with natural guitar fingering.</p>								

NTR/NTT (Note Transposition Rule/Note Transposition Table)	NTT Type	Selects the Note Transposition Table which determines how the notes in the Source Pattern are transposed according to the Chord Type change.	
		When NTR is set to “Root Trans” or “Root Fixed”:	
		Bypass	When NTR is set to Root Fixed, the transposition table used does not do any note conversion. When NTR is set to Root Trans, the table used only converts the notes by maintaining the pitch relationship between notes.
		Melody	Suitable for melody line transposition. Use this for melody channels such as “Phrase1” and “Phrase2.”
		Chord	Suitable for chordal parts transposition. Use this for the “Chord1” and “Chord2” channels, especially when they contain piano or guitar-like chordal parts.
		Melodic Minor	When the played chord changes from a major to a minor chord, this table lowers the third interval in the scale by a semitone. When the chord changes from a minor to a major chord, the minor third interval is raised by a semitone. Other notes are not changed. Use this for melody channels of Sections which respond only to major/minor chords, such as Intros and Endings.
		Melodic Minor 5th	In addition to the Melodic Minor transposition above, augmented and diminished chords affect the 5th note of the Source Pattern.
		Harmonic Minor	When the played chord changes from a major to a minor chord, this table lowers the third and sixth intervals in the scale by a semitone. When the chord changes from a minor to a major chord, the minor third and flatted sixth intervals are raised by a semitone. Other notes are not changed. Use this for chord channels of Sections which respond only to major/minor chords, such as Intros and Endings.
		Harmonic Minor 5th	In addition to the Harmonic Minor transposition above, augmented and diminished chords affect the 5th note of the Source pattern.
		Natural Minor	When the played chord changes from a major to a minor chord, this table lowers the third, sixth and seventh intervals in the scale by a semitone. When the chord changes from a minor to a major chord, the minor third, flatted sixth and flatted seventh intervals are raised by a semitone. Other notes are not changed. Use this for chord channels of Sections which respond only to a major/minor chord such as Intros and Endings.
		Natural Minor 5th	In addition to the Natural Minor transposition above, augmented and diminished chords affect the 5th note of the Source pattern.
		Dorian	When the played chord changes from a major to a minor chord, this table lowers the third and seventh intervals in the scale by a semitone. When the chord changes from a minor to a major chord, the minor third and flatted seventh intervals are raised by a semitone. Other notes are not changed. Use this for chord channels of Sections which respond only to a major/minor chord such as Intros and Endings.
		Dorian 5th	In addition to the Dorian transposition above, augmented and diminished chords affect the 5th note of the Source pattern.
		When NTR is set to “Guitar”:	
		All Purpose	This table covers both strummed and arpeggio-played sounds.
Stroke	Suitable for strumming sounds of the guitar. Some notes may sound as if they are muted—this is the normal condition when chords are played on guitar by strumming.		

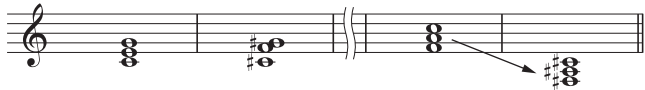
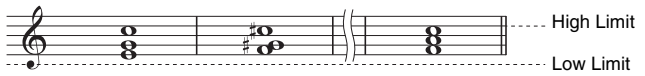
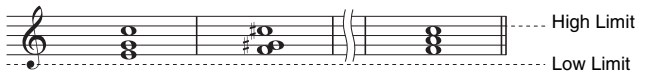
NTR/NTT (Note Transposition Rule/Note Transposition Table)	NTT Type	Arpeggio	Suitable for arpeggio-played sound of the guitar, resulting in beautiful four-note arpeggio sounds.
	NTT Bass	The channel for which this is set to “On” will be played back by the bass root note, when the on-bass chord is recognized by the instrument. When NTR is set to Guitar and this parameter is set to “On,” only the note which is assigned to bass will be played back by the bass root note.	
	NTR/NTT Settings for the Rhythm Channels Since the Rhythm channels should not be affected by Chord change, make sure to make the following settings. <ul style="list-style-type: none"> • NTR = Root Fixed • NTT = Bypass • NTT Bass = Off With the above settings, the “Source Root” and “Source Chord” parameters are changed to “Play Root” and “Play Chord,” respectively.		
High Key/Note Limit	Adjusts the Octave of the notes converted via the NTT and NTR.		
	High Key	This sets the highest key (upper octave limit) of the note transposition for the chord root change. Any notes calculated to be higher than the highest key are transposed down to the next lowest octave. This setting is available only when the NTR parameter (page 63) is set to “Root Trans.” Example — When the highest key is F Root changes → CM C#M . . . FM F#M . . . Notes played → C3-E3-G3 C#3-F3-G#3 F3-A3-C4 F#2-A#2-C#3 	
	Note Limit Low	These set the note range (highest and lowest notes) for Voices recorded to the Style channels. By judicious setting of this range, you can ensure that the Voices sound as realistic as possible — in other words, that no notes outside the natural range are sounded (e.g., high bass sounds or low piccolo sounds). Example — When the lowest note is C3 and the highest is D4 Root changes → CM C#M . . . FM . . . Notes played → E3-G3-C4 F3-G#3-C#4 F3-A3-C4 	
Note Limit High	These set the note range (highest and lowest notes) for Voices recorded to the Style channels. By judicious setting of this range, you can ensure that the Voices sound as realistic as possible — in other words, that no notes outside the natural range are sounded (e.g., high bass sounds or low piccolo sounds). Example — When the lowest note is C3 and the highest is D4 Root changes → CM C#M . . . FM . . . Notes played → E3-G3-C4 F3-G#3-C#4 F3-A3-C4 		
RTR (Retrigger Rule)	These settings determine whether notes stop sounding or not and how they change pitch in response to chord changes.		
	Stop	The notes stop sounding.	
	Pitch Shift	The pitch of the note will bend without a new attack to match the type of the new chord.	
	Pitch Shift to Root	The pitch of the note will bend without a new attack to match the root of the new chord. However, the octave of the new note remains the same.	
	Retrigger	The note is retriggered with a new attack at a new pitch corresponding to the next chord.	
Retrigger To Root	The note is retriggered with a new attack at the root note of the next chord. However, the octave of the new note remains the same.		

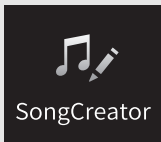

Creating/Editing MIDI Songs (Song Creator)

The Owner's Manual covers how to create an original Song by recording your keyboard performance (see instructions of Realtime Recording). This Reference Manual shows how to create an original Song by entering notes one by one (instructions of the Step Recording) and how to improve the already created Song by editing the detailed parameters.

■ Realtime Recording and Step Recording

When creating a Song, these two Recording methods are available. With Realtime Recording, this instrument records the performance data as it is played. With Step Recording, you can compose your performance by "writing" it down one event at a time. For instructions about the Realtime Recording, refer to the Owner's Manual, Chapter 6. As the method of re-recording a specific part of a Song in realtime, you can use the Punch In/Out function (page 89).

This chapter covers mainly the instructions of Step Recording.

■ MIDI Song Data Structure

A MIDI Song consists of 16 MIDI channels. You can create data of a MIDI Song by recording your performance to a specific channel or channels in realtime, or by executing Step Recording.

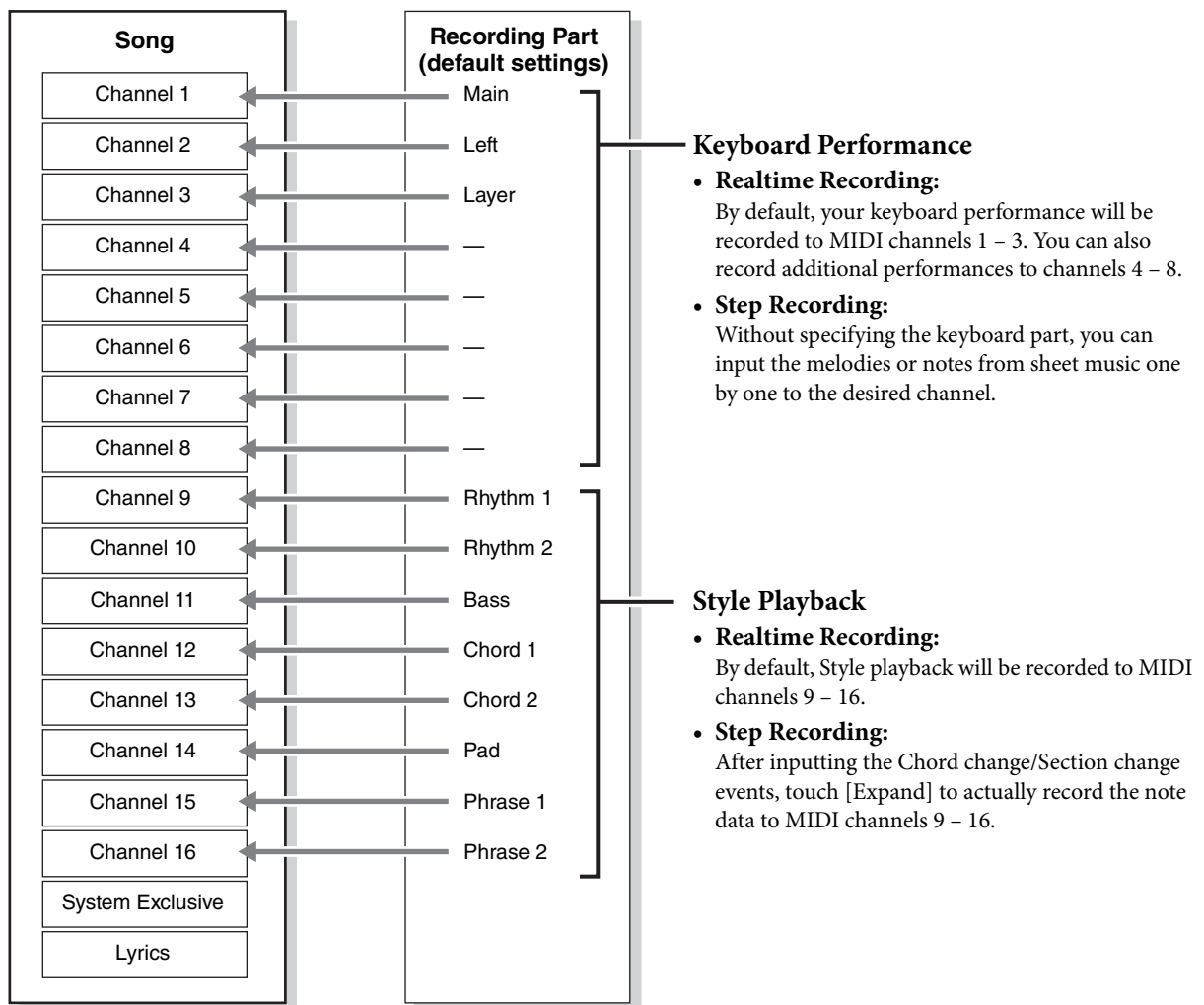



■ Basic Procedure for creating a Song

This section covers the basic procedure for Step Recording.

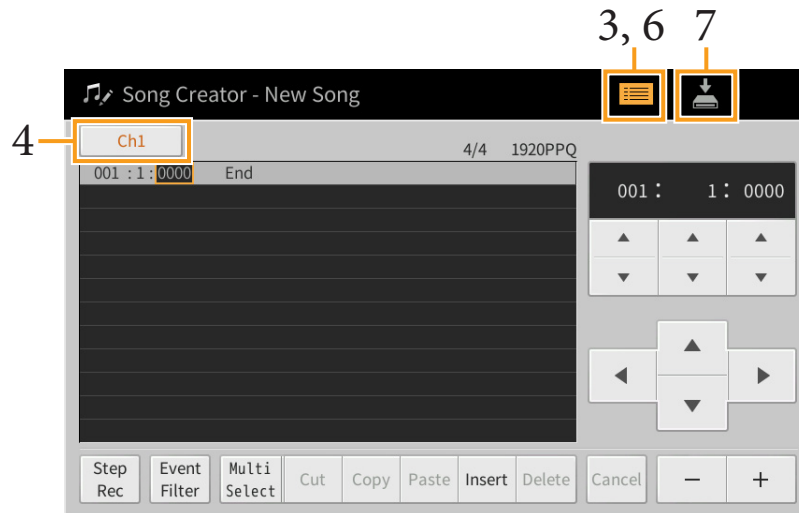
- 1 Select the desired Song or create a new empty Song.**
To create an empty Song, press the [●] (REC) button, then touch [New MIDI] and [Cancel] in order.
- 2 Call up the Song Creator display via [Menu] → [SongCreator].**
- 3 Touch  (Edit) at the top of this display to call up the Song Edit display.**



- 4 Touch [Ch1] at the top left of this display to select the Recording Target channel.**
 - If you want to record the keyboard performance, select one of “Ch1” – “Ch8.” If you do not intend to use Style playback for the Song, “Ch9” – “Ch16” can be selected.
 - If you want to edit the System Exclusive data, select “SysEx.”
 - If you want to edit Lyrics, select “Lyrics.”
 - If you want to record Style playback (Chord change and Section change events), select “Chord.”
- 5 According to selection in step 4, execute the Step Recording or data edits.**
 - **When one of “Ch1” – “Ch16” is selected:**
For instructions on editing already recorded data, refer to [page 73](#).
For instructions on inputting melodies via Step Recording, touch [Step Rec] at the bottom left of the display then refer to [page 68](#).
 - **When “SysEx” is selected:**
Edit the already recorded data, following the explanations on [page 73](#). Step Recording is not available.
 - **When “Lyrics” is selected:**
Edit the already recorded data, following the explanations on [page 73](#). Step Recording is not available.
 - **When “Chord” is selected:**
For instructions on editing already recorded data, refer to [page 73](#).
For instructions on inputting Chord/Section Change events for Style playback via Step Recording, touch [Step Rec] then refer to [page 71](#).
- 6 If necessary, touch  (Edit) to return to the portal display of the Song Creator, then execute the Channel Edit function ([page 76](#)).**
- 7 Touch  (Save) at the top right of the display to save the created Song.**

NOTICE

The recorded Song data will be lost if you select another Song or turn off the power to the instrument without executing the Save operation.

Recording Melodies via Step Recording

The explanations here apply when one of “Ch1” – “Ch16” is selected in step 5 on [page 67](#). With [Step Rec] turned on at the bottom left of the display, you can input the notes one by one, using the controls below.

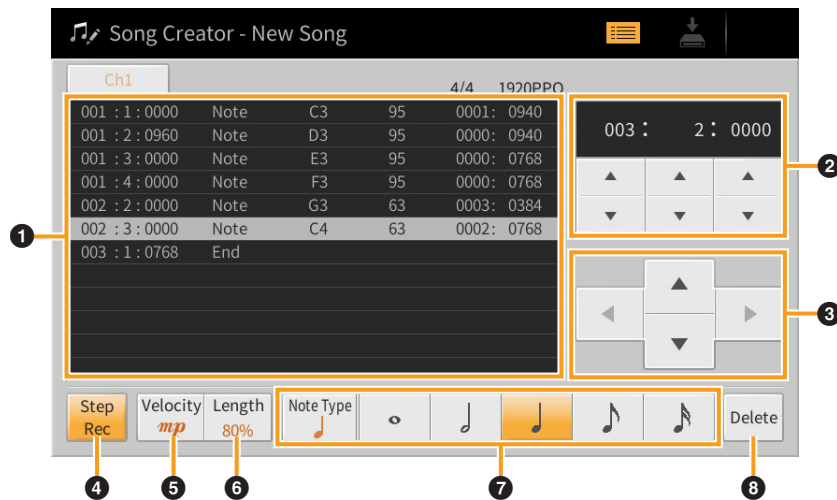

■ Control Names and Functions

①	Event List	Indicates events such as note and Voice selection which have been input. For details, refer to page 74 .								
②	Song Position (Measure: Beat: Clock)	Indicates the current Song position. Events such as note and Voice selection you have input are recorded at the position indicated here. You can change the current position by touching [▲] or [▼] below the Measure, Beat, and Clock* respectively. *Clock Smallest unit for the Song position and note length. A quarter note consists of 1920 clocks.								
③	Cursor	Lets you move the cursor position.								
④	Step Rec	Turning this on shows the Step Recording display, and turning it off shows the Song Edit display.								
⑤	Velocity	Determines the velocity (loudness) of the note to be entered. The velocity value can be specified within a range from 1 to 127. The higher the velocity value, the louder the sound becomes. Kbd.Vel: Actual resulting velocity <table style="margin-left: 20px;"> <tr> <td><i>fff</i> : 127</td> <td><i>mp</i> : 63</td> </tr> <tr> <td><i>ff</i> : 111</td> <td><i>p</i> : 47</td> </tr> <tr> <td><i>f</i> : 95</td> <td><i>pp</i> : 31</td> </tr> <tr> <td><i>mf</i> : 79</td> <td><i>ppp</i> : 15</td> </tr> </table>	<i>fff</i> : 127	<i>mp</i> : 63	<i>ff</i> : 111	<i>p</i> : 47	<i>f</i> : 95	<i>pp</i> : 31	<i>mf</i> : 79	<i>ppp</i> : 15
<i>fff</i> : 127	<i>mp</i> : 63									
<i>ff</i> : 111	<i>p</i> : 47									
<i>f</i> : 95	<i>pp</i> : 31									
<i>mf</i> : 79	<i>ppp</i> : 15									
⑥	Length	Determines the gate time (note length) of the note to be entered. <table style="margin-left: 20px;"> <tr> <td>Normal: <input type="range" value="80%"/> 80%</td> <td>Staccato: <input type="range" value="40%"/> 40%</td> </tr> <tr> <td>Tenuto: <input type="range" value="99%"/> 99%</td> <td>Staccatissimo: <input type="range" value="20%"/> 20%</td> </tr> </table> <p>Manual: For freely setting the gate time. Touch “Manual” and close the pop-up window by touching “OK,” then set the gate time to any desired percentage by using the Data dial.</p>	Normal: <input type="range" value="80%"/> 80%	Staccato: <input type="range" value="40%"/> 40%	Tenuto: <input type="range" value="99%"/> 99%	Staccatissimo: <input type="range" value="20%"/> 20%				
Normal: <input type="range" value="80%"/> 80%	Staccato: <input type="range" value="40%"/> 40%									
Tenuto: <input type="range" value="99%"/> 99%	Staccatissimo: <input type="range" value="20%"/> 20%									

7	Note Type, Note Indication	Touching [Note Type] repeatedly will alternate the type of the note indications at right in order: normal, dotted, and triplet. Select one of three types, then select (turn on) one of the note indications with which the next note is input. If you touch the selected note indication (which is turned on) again, a rest will be input with the corresponding length.
8	Delete	Deletes the selected data.

■ Example of Step Recording — Melodies

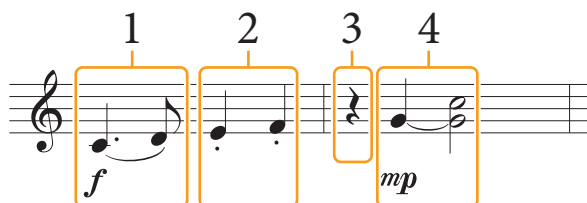

- The numbers shown in the illustration correspond to the following operation step numbers.
- The illustration given here is just a sample. Since the music score (called up via [Menu] → [Score]) is generated from recorded MIDI data, it may not appear exactly the same as shown above. Non-note musical performance symbols will not be shown in the Score display, even if you've entered them.

This section describes the instructions on inputting the melodies of the above notation via the Step Recording. Before starting, note the following points:

- To input the note with the tie in step 4, you need to operate without releasing the key. Proceed with the operations, reading the instructions carefully.
- Before inputting notes as described below, select the desired Voice by using the Voice buttons. Even if it has already been selected, you need to re-select the same Voice to input the Voice number to the Event List. Keep in mind that only note and Voice selection events can be input with Step Recording.

1 Enter the first and second notes with a slur.

- 1-1 Touch [Velocity] to select “*f*.”
- 1-2 Touch [Length] to select “99% (Tenuto).”
- 1-3 Touch [Note Type] once or twice to call up the dotted note type.
- 1-4 Touch the dotted quarter-note length (♩.) to turn it on.
- 1-5 Press the C3 key.

With the operations above, the first note has been entered. Next, enter the second note.

- 1-6 Touch [Note Type] once or twice to call up the normal note indications.
- 1-7 Touch the eighth-note length (♪) to turn it on.
- 1-8 Press the D3 key.

The first and second notes are entered with a slur.

2 Enter the next notes with staccato.

- 2-1 Touch [Length] to select “40% (Staccato).”
- 2-2 Touch the quarter-note length (♩) to turn it on.
- 2-3 Play the keys E3 and F3 in order.

The first measure has been completed.

3 Enter a quarter-note rest.

Touch the quarter-note (♩), that has been turned on, just once to input a quarter-note rest.

Be careful not to touch the same note (which is turned on) several times. Doing so results in multiple rest being input for the corresponding times. Rests are not actually indicated as such in the Event List, but you can confirm whether any have been input or not by checking the Song Position.

4 Enter the next notes and apply a tie.

4-1 Touch [Velocity] to select “*mp*.”

4-2 Touch [Length] to select “80% (Normal).”

4-3 While holding G3 key on the keyboard, touch quarter-note (♩).

Do not release the G3 key yet. Keep holding it while executing the following steps.

4-4 While holding the G3 key, press the C4 key.

Do not release the G3 and C4 keys yet. Keep holding the notes while executing the following step.

4-5 While holding the keys G3 and C4, touch half-note (♪).

After touching half-note (♪), release the keys.

The second measure has been completed.

5 Press the SONG CONTROL [■](STOP) button to return to the top of the Song, then hear the newly entered Song by pressing the [▶ / ■■](PLAY/PAUSE) button.

Recording Chord/Section Change Events via Step Recording

The explanations here apply when “Chord” is selected in step 5 on [page 67](#). With [Step Rec] turned on at the bottom left of the display, you can input the Chord/Section Change events for Style playback one by one.

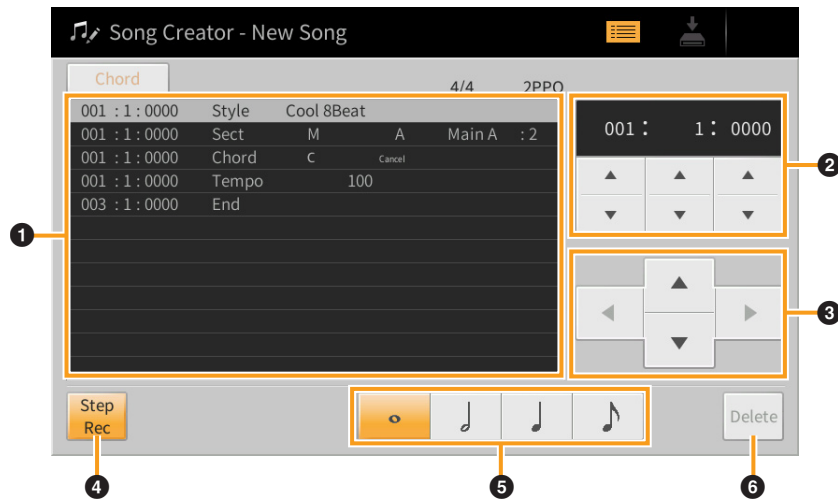

■ Control Names and Functions

①	Event List	Indicates events such as Chord and Section changes which have been input. For details, refer to page 74 .
②	Song Position (Measure: Beat: Clock)	Indicates the current Song position. Events such as Chord and Section change you have input are recorded at the position indicated here. You can change the current position by touching [▲] or [▼] below the Measure, Beat, and Clock* indications respectively. *Clock Smallest unit for the Song position and note length. A quarter note consists of 1920 clocks.
③	Cursor	Lets you move the cursor position.
④	Step Rec	Turning this on shows the Step Recording display, and turning it off shows the Song Edit display.
⑤	Note Indications	Select one of the four note lengths for inputting the next event.
⑥	Delete	Deletes the selected data.

■ Example of Step Recording — Chord/Section Events

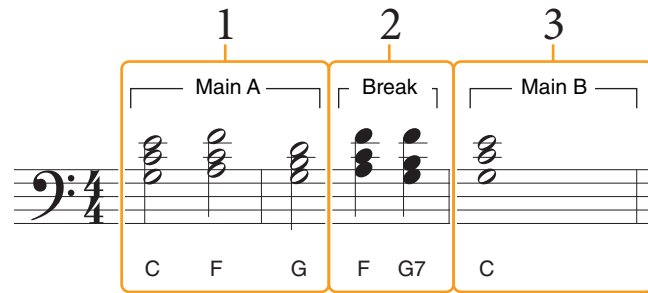

* The numbers shown in the illustration correspond to the following operation step numbers.

These instructions show how to input the Chord/Section change events of the above notation via Step Recording. Before starting, note the following points:

- Turn off the STYLE CONTROL [AUTO FILL IN] button on the panel.
- Select a conventional 4-beat Style.

NOTE In order to detect the chord played in the chord section of the keyboard, set the Fingering type (page 6) to a setting other than “Full Keyboard” and “AI Full Keyboard.” Also, you need to set the “Stop ACMP” parameter to a setting other than “Disabled” in the Style Setting display (page 84).

1 Enter the chords for the Main A section.

- 1-1 Press the MAIN VARIATION [A] button.
- 1-2 Touch the half-note length (♩) to turn it on.
- 1-3 Play the chords C, F and G in the chord section of the keyboard.

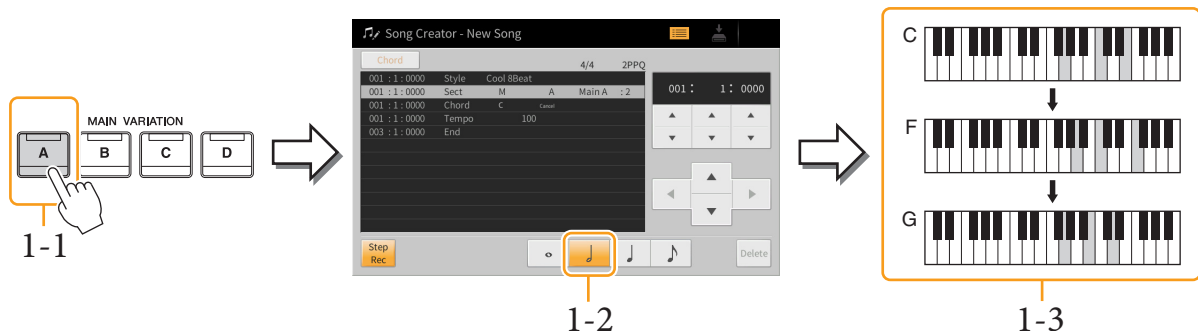

2 Enter the chords for the Break section.

- 2-1 Press the [BREAK] button.
- 2-2 Touch the quarter-note length (♩) to turn it on.
- 2-3 Play the chords F and G7 in the chord section of the keyboard.

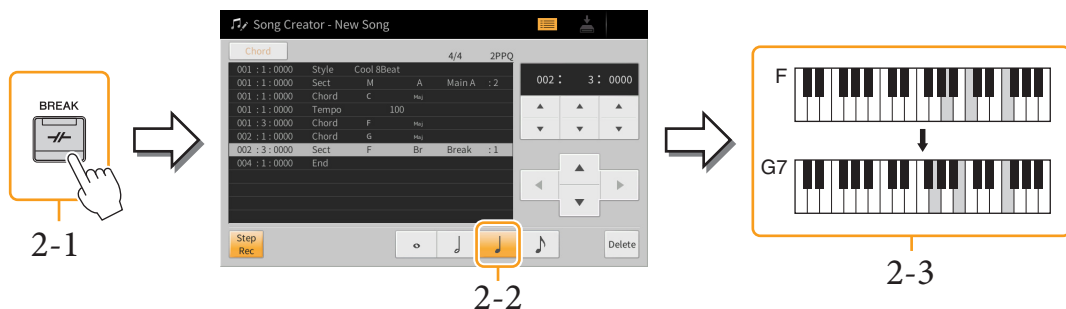

NOTE To enter fill-ins, turn the [AUTO FILL IN] button to on, and simply press the desired MAIN VARIATION [A] – [D] button.

3 Enter the chords for the Main B section.

- 3-1 Press the MAIN VARIATION [B] button.
- 3-2 Touch the whole-note length (●) to turn it on.
- 3-3 Play the chord C in the chord section of the keyboard.

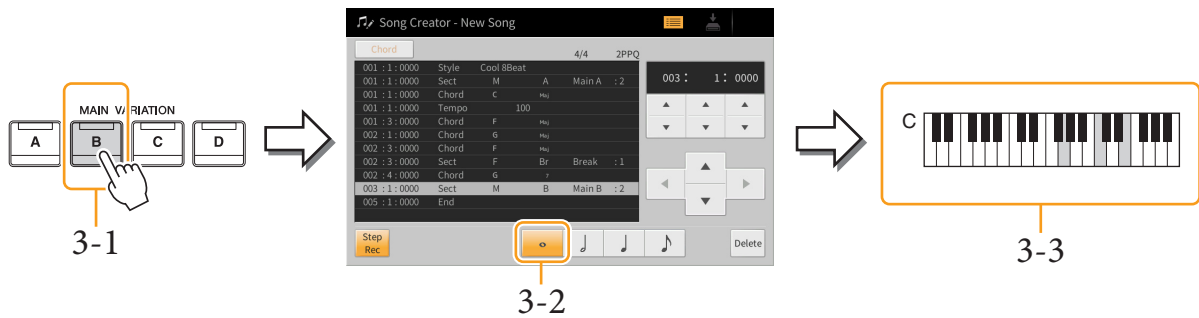

The Chord and Section change events are now entered.

- 4 Press the SONG CONTROL [■](STOP) button to return to the top of the Song, then listen to the newly entered Song by pressing the [▶/■](PLAY/PAUSE) button.
- 5 Touch and turn off [Step Rec] to call up the Song Edit display.
- 6 Touch [Expand] at the upper left of the Song Edit display to convert the Chord/Section change events to the Song data.



With the operations above (steps 1 – 3), only Chord and Section change events are recorded, meaning that the actual Song data has not been created and the Style part can produce no sound even if you start Song playback after exiting from the Song Creator. Accordingly, make sure to execute the Expand function after you finish inputting. If you have not finished inputting, save the Song to maintain the recorded events then continue inputting additional events as desired in the future.

Editing the Recorded Data

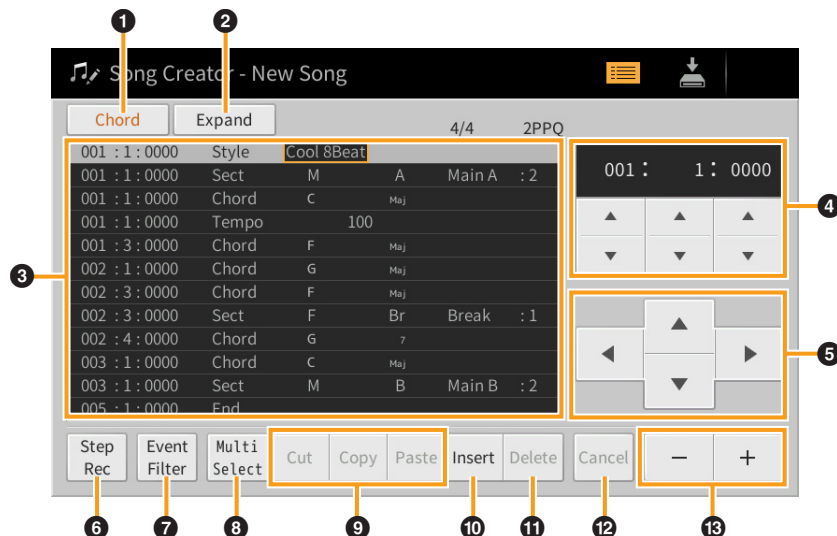
The explanations here apply to step 5 on page 67. From the Song Edit display, you can edit each of the events such as Note data and Voice selection which are created via Realtime Recording or Step Recording.

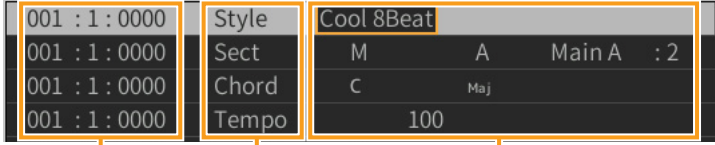

❶	Editing Target	<p>Specifies the Editing Target.</p> <ul style="list-style-type: none"> • Ch 1 – Ch 16: When one of these is selected, you can edit the channel data. • SysEx: Lets you edit System Exclusive data which applies to all channels. • Lyrics: Lets you edit Lyrics data. • Chord: Lets you edit Chord/Section change events for Style playback. 																				
❷	Expand	<p>This is shown only when “Chord” is selected above, and lets you convert the Chord/Section change events you input in the Step Recording display to actual sounded note data. Make sure to execute this function when finalizing Song data. If you exit from the Song Creator without executing this function, starting Song playback produces no sound of the Style part.</p>																				
❸	Event List	<p>In this area, the events of the Song data are listed and can be edited. Each line shows one event.</p>  <p>Indicates the Song position (measure: beat: clock) of the corresponding event. Indicates the event type. Indicates the event value or detail.</p> <p>Depending on the Editing Target above (❶), the listed and editable events differ as described below.</p> <p>■ When the Editing Target is set to one of “Ch1” – “Ch16”:</p> <table border="1" data-bbox="454 1025 1439 1585"> <tr> <td>Note</td> <td>An individual note within a Song. Includes the note name which corresponds to the key which was played, plus a velocity value based on how hard the key is played, and the gate time value (the length of a note).</td> </tr> <tr> <td>Ctrl (Control Change)</td> <td>Settings to control the Voice, such as volume, pan, filter and effect depth (edited via the Mixer), etc.</td> </tr> <tr> <td>Prog (Program Change)</td> <td>MIDI program change number for selecting a Voice.</td> </tr> <tr> <td>P.Bnd (Pitch Bend)</td> <td>Data for changing the pitch of a Voice continuously.</td> </tr> <tr> <td>A.T. (Aftertouch)</td> <td>This event is generated when pressure is applied to a key after the key is pressed. Note that the keyboard of this instrument does not feature Aftertouch, although Aftertouch values can be entered here.</td> </tr> </table> <p>■ When the Editing Target is set to “SysEx”:</p> <table border="1" data-bbox="454 1653 1439 2067"> <tr> <td>ScBar (Score Start Bar)</td> <td>Determines the top measure number as the starting point of the Song data.</td> </tr> <tr> <td>Tempo</td> <td>Determines the tempo value.</td> </tr> <tr> <td>Time (Time signature)</td> <td>Determines the time signature</td> </tr> <tr> <td>Key (Key signature)</td> <td>Determines the key signature, as well as the major/minor setting, for the music score shown on the display.</td> </tr> <tr> <td>XGPrm (XG parameters)</td> <td>Allows you to make various detailed changes to the XG parameters. For details, refer to “MIDI Data Format” in the Data List (separate PDF).</td> </tr> </table>	Note	An individual note within a Song. Includes the note name which corresponds to the key which was played, plus a velocity value based on how hard the key is played, and the gate time value (the length of a note).	Ctrl (Control Change)	Settings to control the Voice, such as volume, pan, filter and effect depth (edited via the Mixer), etc.	Prog (Program Change)	MIDI program change number for selecting a Voice.	P.Bnd (Pitch Bend)	Data for changing the pitch of a Voice continuously.	A.T. (Aftertouch)	This event is generated when pressure is applied to a key after the key is pressed. Note that the keyboard of this instrument does not feature Aftertouch, although Aftertouch values can be entered here.	ScBar (Score Start Bar)	Determines the top measure number as the starting point of the Song data.	Tempo	Determines the tempo value.	Time (Time signature)	Determines the time signature	Key (Key signature)	Determines the key signature, as well as the major/minor setting, for the music score shown on the display.	XGPrm (XG parameters)	Allows you to make various detailed changes to the XG parameters. For details, refer to “MIDI Data Format” in the Data List (separate PDF).
Note	An individual note within a Song. Includes the note name which corresponds to the key which was played, plus a velocity value based on how hard the key is played, and the gate time value (the length of a note).																					
Ctrl (Control Change)	Settings to control the Voice, such as volume, pan, filter and effect depth (edited via the Mixer), etc.																					
Prog (Program Change)	MIDI program change number for selecting a Voice.																					
P.Bnd (Pitch Bend)	Data for changing the pitch of a Voice continuously.																					
A.T. (Aftertouch)	This event is generated when pressure is applied to a key after the key is pressed. Note that the keyboard of this instrument does not feature Aftertouch, although Aftertouch values can be entered here.																					
ScBar (Score Start Bar)	Determines the top measure number as the starting point of the Song data.																					
Tempo	Determines the tempo value.																					
Time (Time signature)	Determines the time signature																					
Key (Key signature)	Determines the key signature, as well as the major/minor setting, for the music score shown on the display.																					
XGPrm (XG parameters)	Allows you to make various detailed changes to the XG parameters. For details, refer to “MIDI Data Format” in the Data List (separate PDF).																					



③	Event List	Sys/Ex. (System Exclusive)	Displays the System Exclusive data in the Song. Keep in mind that you cannot create new data or change the contents of the data here; however, you can delete, cut, copy, and paste the data.
		Meta (Meta event)	Displays the SMF meta events in the Song. Keep in mind that you cannot create new data or change the contents of the data here; however, you can delete, cut, copy, and paste the data.
		■ When the Editing Target is set to “Lyrics”:	
		Name	Allows you to enter the Song name.
		Lyrics	Allows you to enter lyrics.
		Code	CR: Enters a line break in the lyrics text. LF: Clears the currently displayed lyrics and displays the next set of lyrics.
		■ When the Editing Target is set to “Chord”:	
		Style	Style name
		Tempo	Tempo setting
		Chord	Chord root, Chord type, On Bass Chord
		Sect (Section)	Style Section (Intro, Main, Fill In, Break, Ending)
		OnOff	On/off status for each part (channel) of the Style
		CH.Vol (Channel Volume)	Volume for each part (channel) of the Style
S.Vol (Style volume)	Overall volume of the Style		
④	Song Position (Measure: Beat: Clock)	Indicates the current Song position. The events you input are recorded at the position indicated here. You can change the current position by touching [▲] or [▼] below the Measure, Beat, and Clock* indications respectively. *Clock Smallest unit for the Song position and note length. A quarter note consists of 1920 clocks.	
⑤	Cursor	Lets you move the cursor position.	
⑥	Step Rec	Turning this on shows the Step Recording display, and turning it off shows the Song Edit display.	
⑦	Event Filter	Calls up the Event Filter window, letting you select only the events you wish to be shown in the event list.  : Checkmark all items.  : Remove checkmarks from all items.  : Invert checked/unchecked for all items.	
⑧	Multi Select	After turning this on, use the Cursor buttons (⑤) on the display to select multiple events.	
⑨	Cut/Copy/Paste	Use these when you want to copy or move the selected events.	
⑩	Insert	Adds a new event.	
⑪	Delete	Deletes the selected events.	
⑫	Cancel	Cancels editing and restores the original value.	
⑬	-/+	Increases or decreases the value of the current cursor position by 1.	

Channel Edit — Editing Channel Data

The explanations here apply to step 6 on [page 67](#). The Channel Edit display lets you correct or convert the specific portion of the Song data.

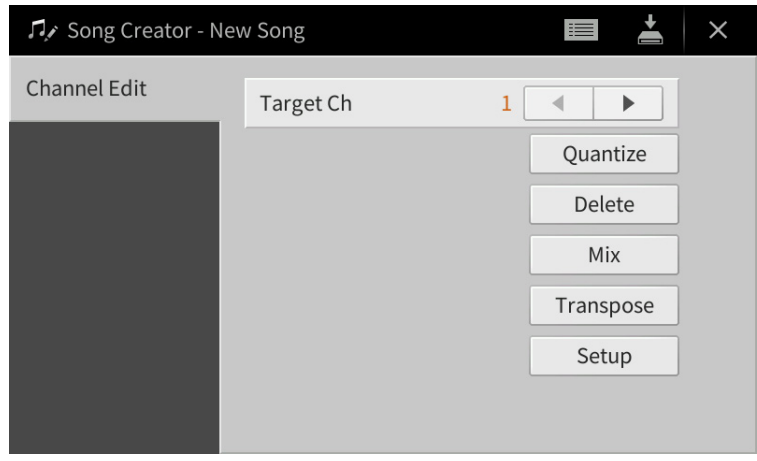
After editing the desired parameter, touch [Execute] to actually enter the edits for each setup window. When execution is completed, this button changes to [Undo], letting you restore the original data if you are not satisfied with the results. The Undo function only has one level; only the previous operation can be undone.

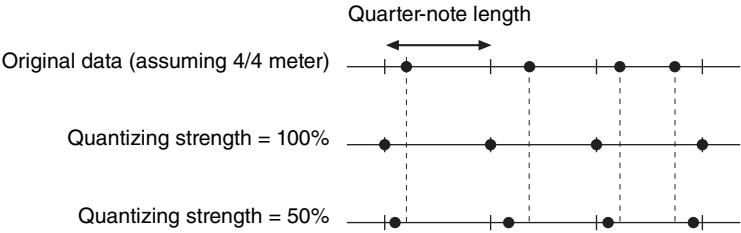

Target Ch	Select the target channel to be edited.										
Quantize	<p>The Quantize function allows you to align the timing of all the notes in a channel. For example, if you record the musical phrase shown below, you may not play it with absolute precision, and your performance may have been slightly ahead of or behind the precise timing. Quantize is a convenient way of correcting for this.</p> 										
Size	<p>Selects the quantize size (resolution). For optimum results, you should set the Quantize size to the shortest note value in the channel. For example, if eighth notes are the shortest in the channel, you should use eighth note as the Quantize size.</p>  <p style="text-align: center;">After 1/8 note quantization</p> <p>Settings:</p> <table style="width: 100%; text-align: center;"> <tr> <td> 1/4 note</td> <td> 1/8 note</td> <td> 1/16 note</td> <td> 1/32 note</td> <td> 1/16 note+ 1/8 note triplet*</td> </tr> <tr> <td> 1/4 note triplet</td> <td> 1/8 note triplet</td> <td> 1/16 note triplet</td> <td> 1/8 note+ 1/8 note triplet*</td> <td> 1/16 note+ 1/16 note triplet*</td> </tr> </table> <p>The three Quantize settings marked with asterisks (*) are exceptionally convenient, since they allow you to quantize two different note values at the same time. For example, when the straight eighth notes and eighth notes triplet are contained in the same channel, if you quantize by the straight eighth notes, all notes in the channel are quantized to straight eighth notes — completely eliminating any triplet feel. However, if you use the eighth note + eighth note triplet setting, both the straight and triplet notes will be quantized correctly.</p>	 1/4 note	 1/8 note	 1/16 note	 1/32 note	 1/16 note+ 1/8 note triplet*	 1/4 note triplet	 1/8 note triplet	 1/16 note triplet	 1/8 note+ 1/8 note triplet*	 1/16 note+ 1/16 note triplet*
 1/4 note	 1/8 note	 1/16 note	 1/32 note	 1/16 note+ 1/8 note triplet*							
 1/4 note triplet	 1/8 note triplet	 1/16 note triplet	 1/8 note+ 1/8 note triplet*	 1/16 note+ 1/16 note triplet*							

Quantize	Strength	<p>Determines how strongly the notes will be quantized. A setting of 100% produces exact timing. If a value less than 100% is selected, notes will be moved toward the specified quantization beats according to the specified percentage. Applying less than 100% quantization lets you preserve some of the “human” feel in the recording.</p> 
Delete	<p>You can delete the data of the specified channel in the Song. Checkmark (touch) the desired channel whose data you wish to delete, then touch [Execute] to actually delete the data.</p>	
Mix	<p>This function lets you mix the data of two channels and place the results in a different channel. It also lets you copy the data from one channel to another.</p>	
	Source 1 Ch	<p>Determines the MIDI channel (1 – 16) to be mixed. All MIDI events of the channel specified here are copied to the destination channel.</p>
	Source 2 Ch	<p>Determines the MIDI channel (1 – 16) to be mixed. Only note events of the channel specified here are copied to the destination channel. Besides the values 1 – 16, there is a “Copy” setting that allows you to copy the data from Source 1 to the destination channel.</p>
	Destination Ch	<p>Determines the channel into which the mix or copy results will be placed.</p>
Transpose	<p>This allows you to transpose the recorded data of individual channels up or down by a maximum of two octaves in semitone increments.</p>	
	1-16	<p>Sets the Transpose value for each channel.</p>
	All -	<p>Decreases the Transpose value for all channels by 1.</p>
	All +	<p>Increases the Transpose value for all channels by 1.</p>
	<p>NOTE Make sure not to transpose channels 9 and 10. In general, Drum kits are assigned to these channels. If you transpose the channels of Drum kits, the instruments assigned to each key will be changed.</p>	
Setup	<p>The current settings of the Mixer display and other panel settings can be recorded to the top position of the Song as the Setup data. The Mixer and panel settings recorded here are automatically recalled when the Song starts.</p> <p>Checkmark the items of playback features and functions that you wish to automatically be called up along with the selected Song.</p> <p>NOTE Before executing the Setup operation, move the Song position to the top of the Song by pressing the SONG [STOP] button.</p>	

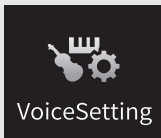

Voice Settings

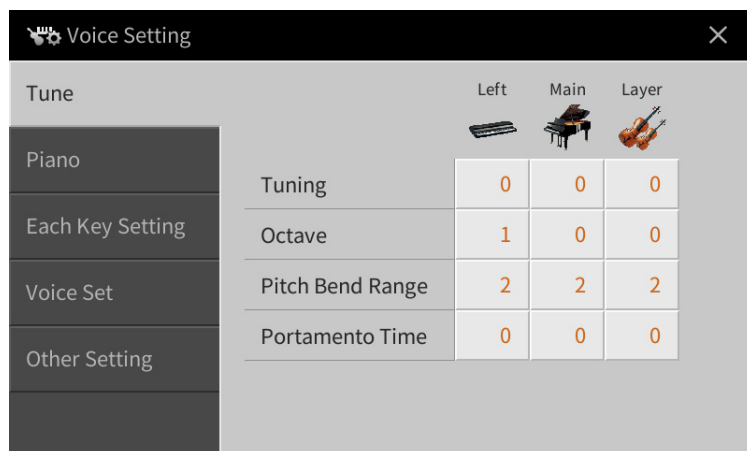

Tune

Lets you adjust the pitch related parameters for each keyboard part.

Tuning	Determines the pitch of each keyboard part.
Octave	Determines the range of the pitch change in octaves, over two octaves up or down for each keyboard part.
Pitch Bend Range	Determines the range of the Pitch Bend for each keyboard part in semitones when the “Pitch Bend” or “Glide” function is assigned to a pedal (page 44).
Portamento Time	Portamento is a function that creates a smooth transition in pitch from the first note played on the keyboard to the next. The Portamento Time determines the pitch transition time. Higher values result in a longer pitch change time. Setting this to “0” results in no effect. This parameter is available for keyboard parts which are set to “Mono” (page 48).

Piano

Lets you set the parameters for the “VRM Piano” category Voices.

VRM*	VRM	Turns the VRM effect on or off.
	Damper Resonance Depth	Adjusts the depth of the VRM effect heard when pressing the damper pedal.
	String Resonance Depth	Adjusts the depth of the VRM effect heard when playing the keyboard.
	Reverb Depth	Adjusts the Reverb depth for VRM Voices.
	Chorus Depth	Adjusts the Chorus depth for VRM Voices.
Key Off Sampling		Adjusts the volume of the key-off sound (the subtle sound that occurs when you release a key). This is not applied to the “Concert Upright” Voice.

*These settings are applied commonly to all parts for which VRM Voices are selected.

Each Key Setting

Lets you adjust the pitch and volume of each note (or key) individually for the “VRM Piano” category Voice selected as the Main part.

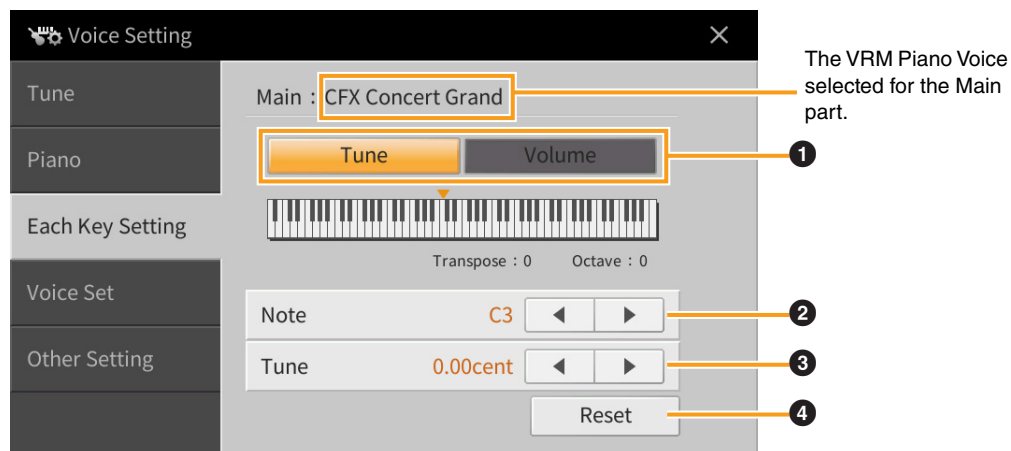

❶	Determines whether you set the pitch (Tune) or the volume is to be set.
❷	Selects the note for changing the pitch or volume. When setting the pitch, you can select the note also by pressing the actual key while holding down the keyboard illustration on the display.
❸	Sets the pitch or the volume. The note for which the setting is changed from the default is colored in the keyboard illustration on the display.
❹	Resets all [Tune] or [Volume] settings to the default.

Voice Set

Each Voice is linked to its default Voice Set parameter settings, equivalent to those in the Voice Edit display (page 47) for the Voices other than the Organ Flutes Voices. Although usually these settings are automatically called up by selecting a Voice, you can also disable this feature. For example, if you want to change the Voice yet keep the same Harmony effect, remove the checkmark of “Keyboard Harmony.”

Other Setting







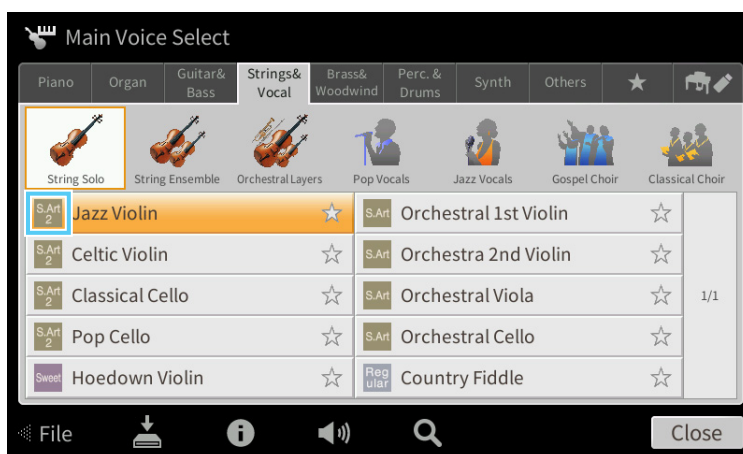







Category Button	<p>Determines how the Voice Selection display is opened when one of the VOICE category buttons is pressed.</p> <ul style="list-style-type: none"> • Open & Select: Opens the Voice Selection display with the previously selected Voice in the Voice category automatically selected (when one of the VOICE category buttons is pressed). • Open Only: Opens the Voice Selection display with the currently selected Voice (when one of the VOICE category buttons is pressed).
S.Art2 Auto Articulation (only for CVP-809)	<p>Determines whether articulation is added to S.Art2 Voices automatically for these respective key timings:</p> <ul style="list-style-type: none"> • Head: When the first key is pressed. • Joint: When the key is pressed or released while holding down other key(s). • Tail: When the last key is released. <p>NOTE This affects not only S.Art2 Voices of your keyboard performance, but also the S.Art2 Voices in Songs or Styles.</p>

Voice Characteristics

In the Voice Selection display, icons defining the Voice characteristics are indicated at the left of the Voice name. For some particular Voices, **i** (Information) is shown at the bottom of the display and detailed information can be called up by touching it.



VRM	Refer to the Owner’s Manual, Chapter 3.
Natural!	Natural! Voices are high quality sounds based on many specialist sampling techniques. They are especially suited to recreating Piano and other keyboard instruments.

 S.Articulation!  S.Articulation2! (only for CVP-809)	Refer to the Owner's Manual, Chapter 3.
 Live!	Live! Voices feature stereo sampling, to reproduce accurately the stereo image of an acoustic instrument, as well as the ambience of the room it was recorded in.
 Cool!	Cool! Voices reproduce the complex characteristics of Electric Instruments, by utilizing sophisticated programming techniques in both voicing, and the use of DSP effects.
 Sweet!	Sweet! Voices are acoustic instruments which feature the sampled vibrato of the original player, creating a far more realistic and emotional performance than synthesized vibrato.
 Drums	Drum & Percussion instruments are mapped across the keyboard so you can play them directly, or use in music production. For information about what sound is assigned to each key, refer to the "Drum/key Assignment List" in the Data List (separate PDF).
 Live!Drums	Stereo sampling is used for these high definition Drum and Percussion instruments, which are mapped across the keyboard so you can play them directly, or use in music production.
 Revo!Drums (only for CVP-809)	These Voices recreate the natural sound of real drums by producing different instrument sound samples (or waveforms), when playing the same key multiple times.
 SFX	Special percussion and sound effects are mapped across the keyboard, so you can play them directly, or use in music production. For information about what sound is assigned to each key, refer to the "Drum/key Assignment List" in the Data List (separate PDF).
 Live!SFX	Stereo sampling is used for these high definition special percussion and sound effects, which are mapped across the keyboard so you can play them directly, or use in music production.
 Revo!SFX (only for CVP-809)	These Voices recreate the natural sound of real percussion instruments by producing different sound samples (or waveforms), when playing the same key multiple times.
 OrganFlutes!	OrganFlutes! lets you create your own Organ registrations, by combining Organ Flute Footages at different pitches, just like a real organ. See page 51 for details.
 Mega Voice	<p>MegaVoice is a special Voice format designed for use in styles and songs, not for live performance. Different velocity ranges are used to select dramatically different playing styles simultaneously, and without changing the voice. Actual sound maps for the MegaVoices are given in the Data List (separate PDF).</p> <p>NOTE MegaVoices are not compatible with other models. Any Song or Style data you've created on this instrument using the MegaVoices will not sound properly when played back on other instruments which do not feature the same MegaVoices.</p> <p>NOTE MegaVoices will sound differently depending on the keyboard range, velocity, touch, etc. Hence, if you apply the Keyboard Harmony effect, change the transpose setting or change the Voice Set parameters, unexpected or undesired sounds may result.</p>
 Regular	Other Voices including GM Voices and XG Voices.

Selecting GM/XG or MegaVoices

This instrument features GM Voices, XG Voices, and MegaVoices. These Voices can be called up from the “Others” category in the Voice Selection display.

- 1 From the Home display, touch the Voice name of the desired part to call up the Voice Selection display.

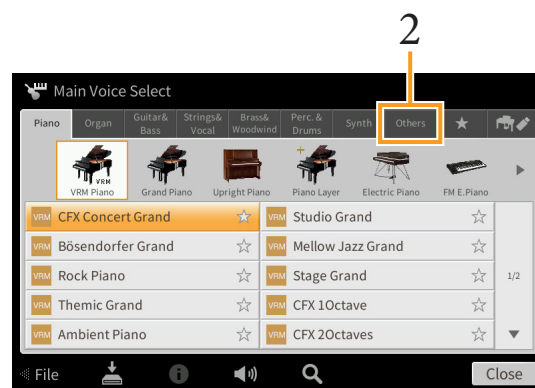

- 2 Touch the tab of the “Others” category.

- 3 Touch  (Above) several times if necessary, to call up the root directory of “Others.”

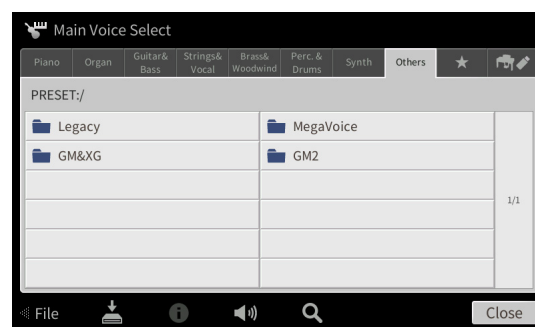
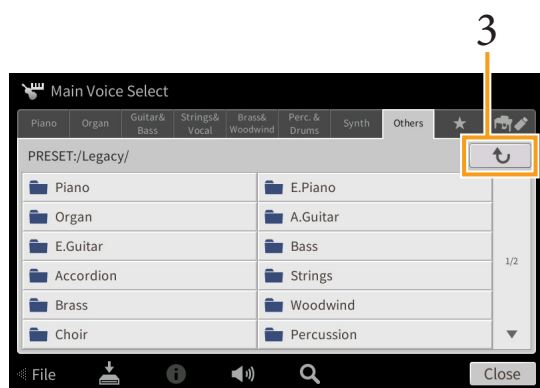

- 4 Touch the desired category, such as “GM&XG” and “MegaVoice.”

NOTE You can find the “Legacy” folder in this display. This folder contains previous Yamaha Clavinova Voices (such as CVP-709, 705 etc.) for data compatibility with other models.

- 5 Select the desired Voice.

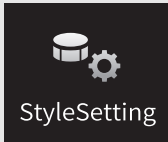

Style Playback Related Settings

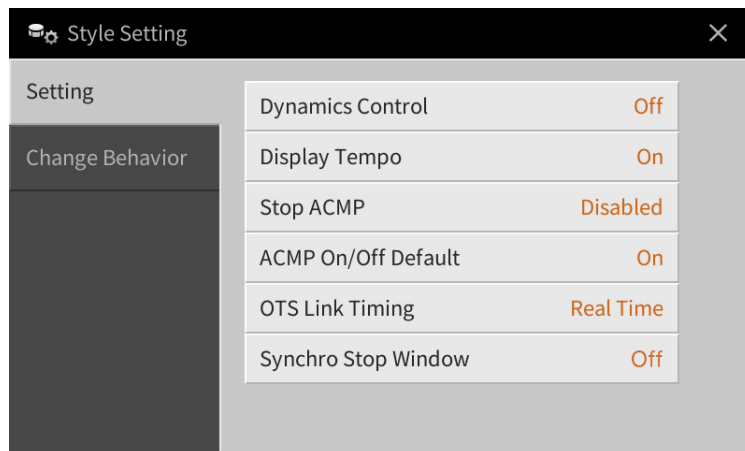

Setting

Dynamics Control	<ul style="list-style-type: none"> • Off: The Style volume does not respond to your playing strength. • Narrow: The Style volume changes over a narrow range in response to your playing strength. In other words, you must play very strongly or softly to have the volume change. • Medium: The Style volume changes normally in response to your playing strength. • Wide: The Style volume changes over a wide range in response to your playing strength. In other words, playing strongly or softly produces greater changes in the volume.
Display Tempo	Turns on or off the tempo indication for each Style on the Style Selection display.
Stop ACMP	<p>When the [ACMP ON/OFF] button is on, [SYNC START] is off, and this parameter is set to the value other than “Disabled,” you can play chords in the chord section of the keyboard with the Style stopped, and still hear the accompaniment chord. In this condition — called “Stop Accompaniment” — any valid chord fingerings are recognized and the chord root/type are shown in the Style area of the Home display. Here, you can determine whether the chord played in the chord section will sound or not in the Stop Accompaniment status.</p> <ul style="list-style-type: none"> • Disabled: Disables the Stop Accompaniment feature. When Style playback is stopped, any pressed notes in the chord section of the keyboard will not be recognized as chords. • Off: The chord played in the chord section will not sound. • Style: The chord played in the chord section will sound via the Voices for the Pad part and the Bass channel of the selected Style. • Fixed: The chord played in the chord section will sound via the specified Voice, regardless of the selected Style. <p>NOTE When the selected Style contains MegaVoices, unexpected sounds may result when this is set to “Style.”</p> <p>NOTE If you record a Song using the Stop Accompaniment, both the Voice that is sounded and the chord data will be recorded when set to “Style,” and only the chord data will be recorded when set to “Off” or “Fixed.”</p> <p>NOTE When this is set to “Disabled,” chords are not recognized while the Style is stopped. This is why both Vocal Harmony (with the Chordal mode) and Keyboard Harmony are not applied even if you play a chord in the chord section of the keyboard while the Style is stopped.</p>

ACMP On/Off Default	Determines whether the [ACMP ON/OFF] button is on or off when the power is turned on.
OTS Link Timing	This applies to the OTS Link function. This parameter determines the timing in which the One Touch Settings change with the MAIN VARIATION [A] – [D] change. (The [OTS LINK] button must be on.) <ul style="list-style-type: none"> • Real Time: One Touch Setting is immediately called up when you press a MAIN VARIATION button. • Next Bar: One Touch Setting is called up at the next measure, after you press a MAIN VARIATION button.
Synchro Stop Window	This determines how long you can hold a chord before the Synchro Stop function is automatically cancelled. When the [SYNC STOP] button is turned on and this is set to a value other than “Off,” the Synchro Stop function is automatically cancelled if you hold a chord for longer than the time set here. This conveniently resets Style playback control to normal, letting you release the keys and still have the Style play. In other words, if you release the keys sooner than the time set here, the Synchro Stop function works.

Change Behavior

Section Set	Determines the default section that is automatically called up when selecting different Styles (when Style playback is stopped). When set to “Off” and Style playback is stopped, the active section is maintained even if the different Style is selected. When any of the MAIN A–D sections is not included in the Style data, the nearest Section is automatically selected. For example, when MAIN D is not contained in the selected Style, MAIN C will be called up.
Tempo	This determines whether the tempo changes or not when you change the Style. <ul style="list-style-type: none"> • Lock: Regardless of playback status, the tempo setting of the previous Style is maintained. • Hold: While the Style is playing back, the tempo setting of the previous Style is maintained. While the Style is stopped, the tempo changes to that of the default tempo of the selected Style. • Reset: Regardless of playback status, the tempo changes to that of the default tempo for the selected Style.
Part On/Off	This determines whether the Style Channel on/off status changes or not when you change the Style. <ul style="list-style-type: none"> • Lock: Regardless of playback status, the Channel on/off status of the previous Style is maintained. • Hold: While the Style is playing back, the Channel on/off status of the previous Style is maintained. While the Style is stopping, all Channels of the selected Style are set to on. • Reset: Regardless of playback status, all Channels of the selected Style are set to on.

Style Characteristics

On the Style Selection display, icons defining the Style characteristics are indicated at left of the Style name.

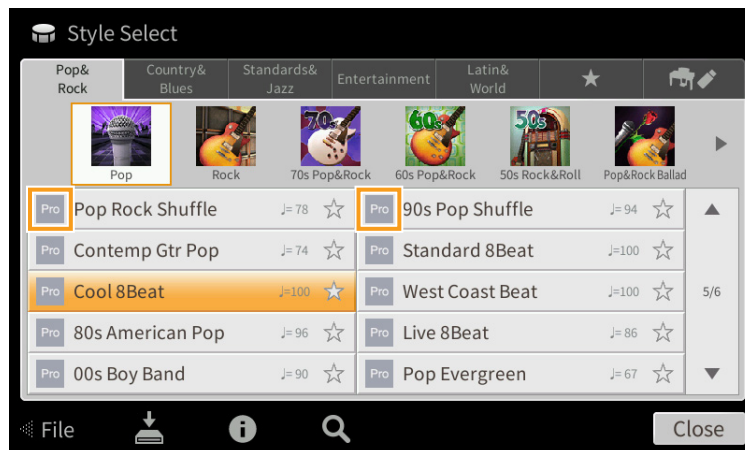

- **Pro:** These Styles provide professional and exciting arrangements combined with perfect playability. The resulting accompaniment exactly follows the chords of the player. As a result, your chord changes and colorful harmonies are instantly transformed into lifelike musical accompaniment.
- **Session:** These Styles provide even greater realism and authentic backing by mixing in original chord types and changes, as well as special riffs with chord changes, with the Main sections. These have been programmed to add “spice” and a professional touch to your performances of certain songs and in certain genres. Keep in mind, however, that the Styles may not necessarily be appropriate or even harmonically correct for all songs and for all chord playing. In some cases for example, playing a simple major triad for a country song may result in a “jazzy” seventh chord, or playing an on-bass chord may result in inappropriate or unexpected accompaniment.
- **Free Play:** These Styles are characterized by rubato performance. You can perform freely with remarkably expressive accompaniment without being constrained by a strict tempo.
- **Pianist:** These special Styles provide piano-only accompaniment. Just by playing the proper chords with your left hand, you can automatically add complicated, professional-sounding arpeggios and bass/chord patterns.

Song Settings Related to Playback/Recording

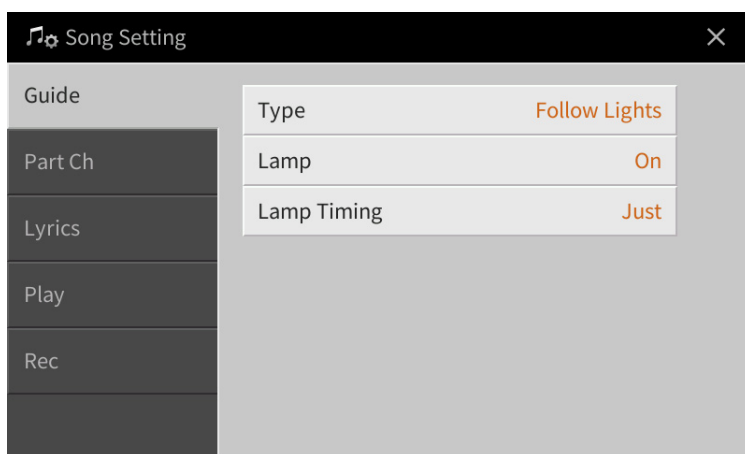

Guide

If you turn on the Guide function and play back a MIDI Song, the keyboard guide lamps indicate the notes (location and timing) for you to play. Also, when you sing along with Song playback, you can control the playback timing by playing the keyboard to match your singing.

The Guide function can be turned on from the Song area (when expanded) of the Home display, Score display, Lyrics display and Text display. For instructions on how to use Guide function, refer to the Owner's Manual, Chapter 5. This section covers the detailed parameters about the Guide function.

<p>Type</p>	<p>Lets you select the Guide type.</p> <p>■ Guide menu for keyboard practice</p> <ul style="list-style-type: none"> • Follow Lights: With this function, the keyboard guide lamps indicate which notes you should play. Song playback pauses and waits for you to play. When you play the correct notes, Song playback continues. • Any Key: With this function, you can play the melody of a Song just by pressing a single key (any key is OK) in time with the rhythm. Song playback pauses and waits for you to play any key. Simply play a key on the keyboard in time with the music and Song playback continues. • Your Tempo: Basically the same as "Follow Lights." In addition, playback tempo will change to match the speed at which you are playing. <p>■ Guide menu for singing</p> <ul style="list-style-type: none"> • Karao-Key: This function lets you control the Song playback timing with just one finger, while you sing along. This is useful for singing along with your own performance. Song playback pauses, waiting for you to sing. Simply play any key on the keyboard (playing the keyboard produces no sound) and Song playback continues.
<p>Lamp</p>	<p>Activates or deactivates the keyboard guide lamp.</p> <p>NOTE If the Guide Lamps do not light as intended in the "Part Ch" display, set the Right to "Ch1" then set the Left to "Ch2."</p>
<p>Lamp Timing</p>	<p>Determines the timing by which the keyboard guide lamps light.</p> <ul style="list-style-type: none"> • Just: The guide lamps light in time with the music, at the same timing you should play. • Next: The guide lamps light slightly ahead of the music, indicating the notes you should play next. The guide lamps flash if you fail to play the keys with the correct timing.

NOTE The Guide settings can be saved as a part of Song data (page 77). When you select the saved Song the next time, the corresponding Guide settings will also be called up.

Part Ch

Right	Determines which channel is assigned to the right-hand part.
Left	Determines which channel is assigned to the left-hand part.
Auto Set	When set to “On,” this automatically sets the proper MIDI channels for the right- and left hand parts pre-programmed in the commercially available Song data. Normally, this should be set to “On.”

Lyrics

Language	<p>Determines the language of the displayed lyrics.</p> <ul style="list-style-type: none"> • Auto: When the language is specified in the Song data, the lyrics are displayed accordingly. When the language is not specified in the Song data, the lyrics language is regarded as “International” below. • International: Handles the displayed lyrics as a western language. • Japanese: Handles the displayed lyrics as Japanese.
-----------------	---

Play

Repeat Mode	<p>Determines how playback of the current MIDI Song or Audio Song is repeated.</p> <ul style="list-style-type: none"> • Off: Plays through the selected Song, then stops. • Single: Plays through the selected Song repeatedly. • All: Continues playback through all the Songs in the specified folder repeatedly. • Random: Continues playback at random through all the Songs in the specified folder repeatedly. <p>NOTE The preset Songs in the “Follow Lights” folder contain the Guide settings. These Songs are inappropriate for use with the “All” or “Random” settings.</p>
Phrase Mark Repeat	Phrase Mark is a pre-programmed part of some Song data, which specifies a certain location (set of measures) in the Song. When this is “On,” the section corresponding to the specified Phrase Mark number is repeatedly played back. This parameter is available only when the MIDI Song containing Phrase Mark settings is selected.
Quick Start	On some commercially available MIDI Song data, certain settings related to the MIDI Song (such as Voice selection, volume, etc.) are recorded to the first measure, before the actual note data. When Quick Start is set to “On,” the instrument reads all initial non-note data of the Song at the highest possible speed, then automatically switches to the appropriate tempo at the first note. This allows you to start playback as quickly as possible, with a minimum pause for reading of data.
MIDI Song Fast Forward Type	<p>Determines the fast forward type of when pressing [▶▶] during MIDI Song playback.</p> <ul style="list-style-type: none"> • Jump: Pressing [▶▶] once instantly sets the playback position to the next measure without sounding. Holding [▶▶] scrolls forward continuously. • Scrub: Pressing and holding [▶▶] plays and sounds the MIDI Song at high speed.
USB MIDI Song Auto Open	When this is set to “On,” connecting the USB flash drive will call up the first MIDI Song in the USB flash drive.
Performance Assistant	Refer to page 89 .

Chord Detection Priority	<p>Determines the priority of the chords for accompaniment, either the ones contained in the MIDI Song being played back or the chord you've just played in the chord section of the keyboard.</p> <ul style="list-style-type: none"> • MIDI Song: Gives priority to the chords contained in the MIDI Song. • Keyboard: Gives priority to the chords you play in the chord section of the keyboard. Set this if you want to practice playing chords with MIDI Song playback. Once you play in the chord section during MIDI song playback, the instrument ignores the chords contained in the MIDI Song until the playback ends.
---------------------------------	--

Playing Backing Parts with the Performance Assistant Technology

This feature lets you play your own backing parts on the keyboard along with MIDI Song playback, and have them sound perfectly appropriate (even though the notes you play might be wrong).

1 Select a MIDI Song containing chord data.

The Performance Assistant Technology is applied only to MIDI Songs containing chord data. To confirm whether the selected Song contains chord data or not, call up the Home display with the Style area shown, then start playback of the Song. If the current Song contains chord data, the current chord type appears in the Style area. After stopping playback, go to the next step.

2 Call up the operation display via [Menu] → [SongSetting] → [Play].

3 Set the Performance Assistant to “On.”

NOTE Selecting a Song will turn off the Performance Assistant.

4 Press the SONG CONTROL [▶/||] (PLAY/PAUSE) button to start playback.

5 Play the keyboard.

Along with MIDI Song playback, try playing a bass line in the left hand area while playing various phrases or chords in the right hand area. Even if you do not know what notes should be played, don't worry and play any keys as desired! Only the harmonically “correct” notes matching the current chord are sounded, regardless of the notes you actually play.

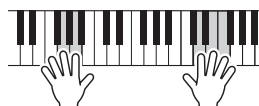

6 Press the SONG CONTROL [■] (STOP) button to stop playback.

Rec

Re-recording a Specific Section of the MIDI Song — Punch In/Out

When re-recording a specific section of an already-recorded MIDI Song, use the Punch In/Out function. In this method, only the data between the Punch In point and the Punch Out point is overwritten with the newly recorded data. Keep in mind that the notes before and after the Punch In/Out points are not recorded over, and you will hear them play back normally to guide you in the Punch In/Out timing.

1 Call up the operation display via [Menu] → [SongSetting] → [Rec] → Page 1/2.

2 Set the parameters such as how the Recording starts/stops and the Punch In/Out position.

NOTE The parameters here cannot be set while recording.

Mode	Rec Start	<p>Determines the recording start behavior.</p> <ul style="list-style-type: none"> • Normal: Overwrite recording starts when Song playback is started via the SONG [▶ /] (PLAY/PAUSE) button or when you play the keyboard in the Synchro Standby mode. • First Key On: The Song plays back normally, then starts overwrite recording as soon as you play the keyboard. • Punch In At: The Song plays back normally up to the beginning of the “Punch In At” measure specified in the Punch In/Out parameter below, then starts overwrite recording at that point.
	Rec Stop	<p>Determines the recording stop behavior, or how data is handled after recording is stopped.</p> <ul style="list-style-type: none"> • Replace All: This deletes all data after the point at which recording is stopped. • Punch Out: The Song position at which recording is stopped is regarded as the Punch Out point. This setting maintains all data after the point at which recording is stopped. • Punch Out At: Actual overwrite recording continues until the beginning of the “Punch Out” measure specified in the Punch In/Out parameter below, at which point recording stops and normal playback continues. This setting maintains all data after the point at which recording is stopped.
Punch In/Out	Punch In At	Specifies the Punch In measure.
	Punch Out At	Specifies the Punch Out measure.
	Pedal Control	<p>When this is set to “On,” you can use the center pedal to control the Punch In and Punch Out points. While a Song is playing back, pressing (and holding) the center pedal instantly enables Punch In recording, while releasing the pedal stops recording (Punch Out). You can press and release the center pedal as often as you want during playback. Note that the current function assignment of the center pedal is cancelled when the Pedal Punch In/Out function is set to “On.”</p> <p>NOTE Pedal Punch In/Out operation may be reversed depending on the particular pedal you’ve connected to the instrument. If necessary, change the pedal polarity to reverse the control (page 43).</p>

3 Select a MIDI Song to be re-recorded.

4 Press the [●](REC) button to call up the Song Recording display, and then confirm that [Overwrite MIDI] is selected.

If the Channel area is not shown, touch [▶] at the left of “Channel.”

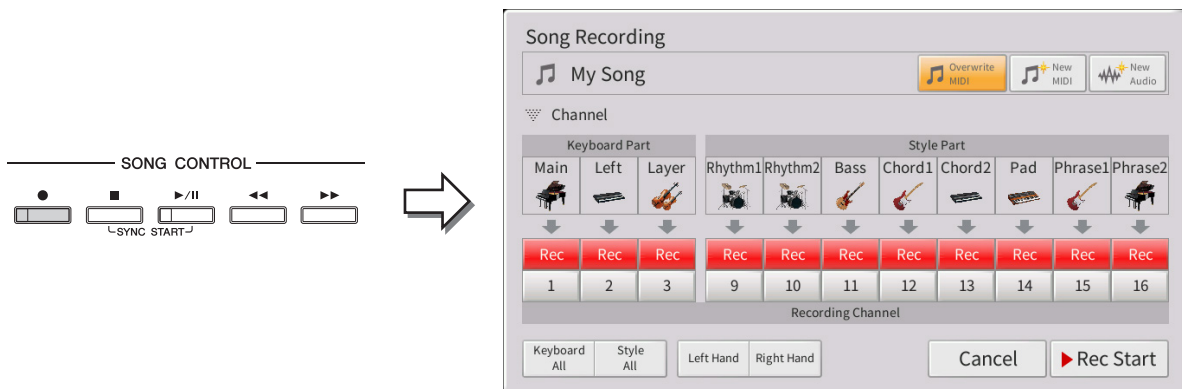

5 From the display, set the part or parts you intended to re-record to [Rec], and set all other parts to [Off].

NOTE For details about the recording channels, refer to the Owner’s Manual, Chapter 6.

6 Press the SONG CONTROL [▶/||] (PLAY/PAUSE) button to start recording.

At the Punch In point specified in step 2, play the keyboard to start actual recording. At the Punch Out point specified in step 2, stop playing the keyboard.

7 Touch  (Save) which appears in the Song area of the Home display to save the recorded Song.

NOTICE

The recorded Song data will be lost if you select another Song or turn the power to the instrument off without executing the Save operation.

Examples of re-recording with various Punch In/Out settings

This instrument features several different ways you use the Punch In/Out function. The illustrations below indicate a variety of situations in which selected measures in an eight-measure phrase are re-recorded.

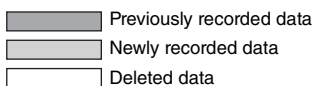
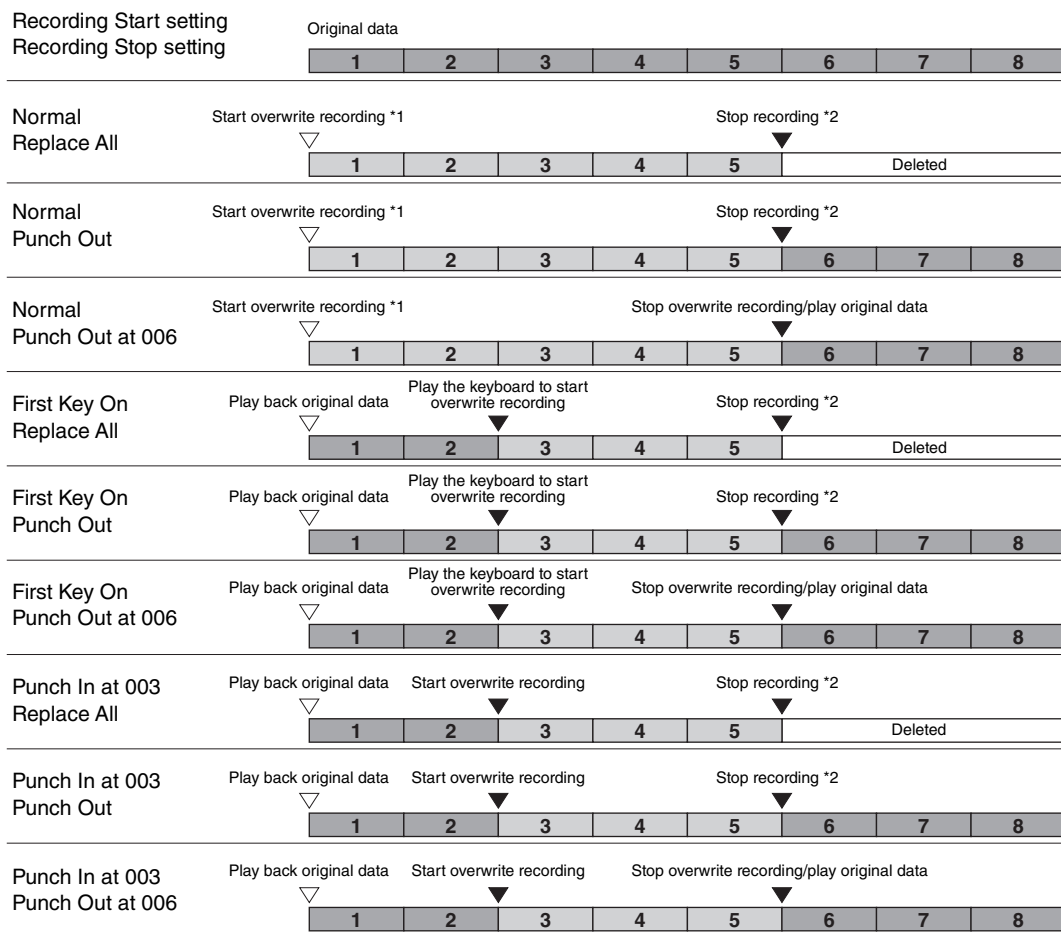

*1 To avoid overwriting measures 1 – 2, start recording from measure 3.
*2 To stop recording, press the [REC] button at the end of measure 5.

Setting the Audio File Format saved via Audio Recording

From the display called up via [Menu] → [SongSetting] → [Rec] → page 2/2, you can specify the Audio file format saved via the Audio recording.

Audio Rec Format	<ul style="list-style-type: none"> • WAV: Your performance will be recorded in WAV format which features higher audio quality than MP3, but the file size will be larger. • MP3 128/256/320kbps: Your performance will be recorded in MP3 format (MPEG-1 Audio Layer-3). The larger the value, the higher the quality, and the larger the data size.
-------------------------	--



Fine Tuning the Pitch

Master Tune – Fine Tuning the Pitch of the Entire Instrument

You can fine-tune the pitch of the entire instrument in 0.2 Hz steps—useful when you play the Clavinova along with other instruments or CD music. Please note that the Tune function does not affect the Drum Kit or SFX Kit Voices and Audio Songs. To restore the default initial setting (440.0 Hz), touch and hold down the setting value for a while.

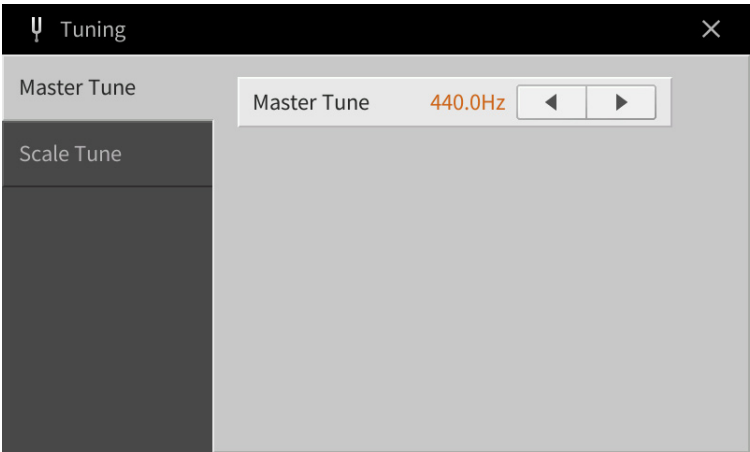

Scale Tune – Selecting or Creating a Temperament

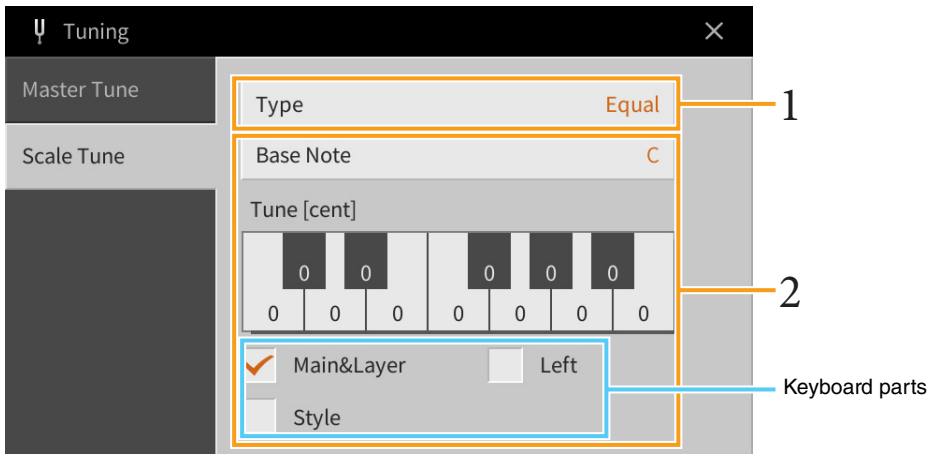

1 Select the desired Scale type (temperament).

You can select one of various scales for playing in custom tunings for specific historical periods or music genres.

Type	<ul style="list-style-type: none"> • Equal: The pitch range of each octave is divided equally into twelve parts, with each half-step evenly spaced in pitch. This is the most commonly used tuning in music today. • Pure Major, Pure Minor: These tunings preserve the pure mathematical intervals of each scale, especially for triad chords (root, third, fifth). You can hear this best in actual vocal harmonies — such as choirs and a cappella singing. • Pythagorean: This scale was devised by the famous Greek philosopher and is created from a series of perfect fifths, which are collapsed into a single octave. The 3rd in this tuning are slightly unstable, but the 4th and 5th are beautiful and suitable for some leads. • Mean-Tone: This scale was created as an improvement on the Pythagorean scale, by making the major third interval more “in tune.” It was especially popular from the 16th century to the 18th century. Handel, among others, used this scale. • Werckmeister, Kirnberger: This composite scale combines the Werckmeister and Kirnberger systems, which were themselves improvements on the mean-tone and Pythagorean scales. The main feature of this scale is that each key has its own unique character. The scale was used extensively during the time of Bach and Beethoven, and even now it is often used when performing period music on the harpsichord. • Arabic1, Arabic2: Use these tunings when playing Arabic music.
-------------	---

2 Change the following settings as necessary.

Base Note	Determines the base note for each scale. When the base note is changed, the pitch of the keyboard is transposed, yet maintains the original pitch relationship between the notes.
Tune [cent]	Select the desired note to be tuned and tune it in cents. If you edit this parameter, “(Edited)” is shown at the right of “Type” in step 1. NOTE In musical terms a “cent” is 1/100th of a semitone. (100 cents equal one semitone.)
(Parts)	Checkmark the part to which the Scale Tune setting is applied.

To store the Scale Tune settings:

If you want to store the Scale Tune settings, use the Registration Memory. Press the REGISTRATION MEMORY [MEMORY] button, then checkmark “Scale Tune” and press one of the REGISTRATION MEMORY [1] – [8] buttons to register the Scale Tune settings.

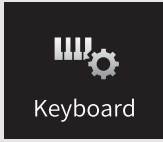

Setting the Touch Sensitivity of the Keyboard

You can adjust the touch response of the instrument (how the sound responds to the way you play the keys). This setting does not change the weight of the keyboard.

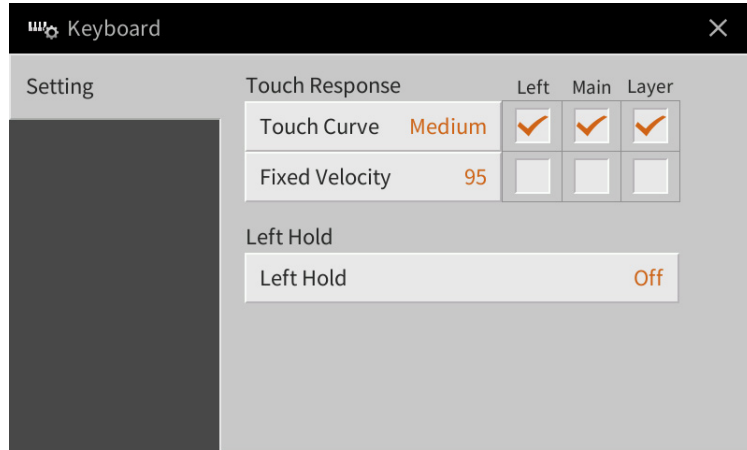

For information about this display, refer to the Owner's Manual, Chapter 1.



Metronome Settings

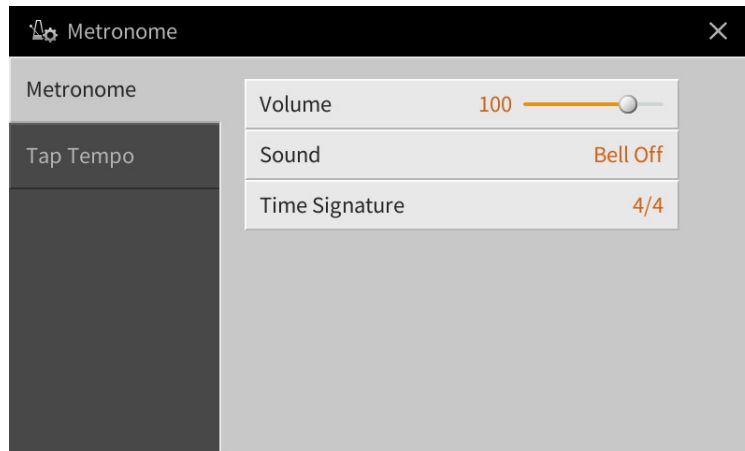

Metronome

Volume	Determines the level of the metronome sound.
Sound	<p>Determines which sound is used for the metronome.</p> <ul style="list-style-type: none"> • Bell Off: Conventional metronome sound, with no bell. • Bell On: Conventional metronome sound, with bell. • English Voice: Count in English • German Voice: Count in German • Japanese Voice: Count in Japanese • French Voice: Count in French • Spanish Voice: Count in Spanish
Time Signature	Determines the time signature of the metronome sound.

Tap Tempo

Volume	Adjusts the volume of the sound triggered when the [TAP TEMPO] button is pressed.
Sound	Selects the percussion instrument as sound triggered when the [TAP TEMPO] button is pressed.

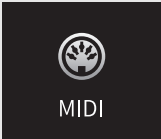

MIDI Settings

In this section, you can make MIDI-related settings for the instrument. This instrument gives you a set of ten pre-programmed templates that let you instantly and easily reconfigure the instrument to match your particular MIDI application or external device. Also, you can edit the pre-programmed templates and save up to ten of your original templates.

NOTE No MIDI signals are received in the Piano Room.

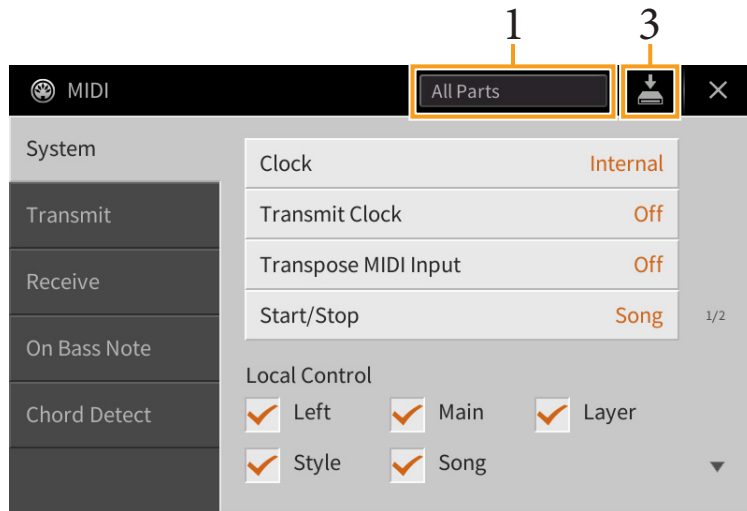

1 Touch the box (shown above), then select a pre-programmed MIDI template (below).

If you have already created an original MIDI template and saved it to User memory (in steps 2 and 3 below), you can also select that template from User memory.

2 If desired, edit the MIDI parameters based on the MIDI template selected in step 1 in the relevant setting display.

- **System:** Lets you set the MIDI System related parameters.....[page 97](#)
- **Transmit:** Lets you set the MIDI Transmission related parameters.....[page 98](#)
- **Receive:** Lets you set the MIDI Reception related parameters.....[page 99](#)
- **On Bass Note:** Lets you select the MIDI channels of which the MIDI data coming from the external MIDI device will be used for detecting the bass note for Style playback..... [page 100](#)
- **Chord Detect:** Lets you select the MIDI channels of which the MIDI data coming from the external MIDI device will be used for detecting the chord type for Style playback..... [page 101](#)

3 When you've finished editing in each display, touch  (Save) to save the MIDI settings as your original MIDI Template.

NOTE Your original MIDI templates can be saved as a single file to a USB flash drive. On the display called up via [Menu] → [Utility] → [Factory Reset/Backup] → page 2/2, touch [Backup] of "MIDI" to execute the Save operation ([page 105](#)).

■ Pre-programmed MIDI Templates

All Parts	Transmits all parts including the keyboard parts (Main, Layer and Left), with the exception of Song parts.
KBD & STYLE	Basically the same as "All Parts" with the exception of how keyboard parts are managed. The right-hand parts are handled as "Upper" instead of Main and Layer, and the left-hand part is handled as "Lower."

Master KBD (Master Keyboard)	In this setting, the instrument functions as a “master” keyboard, playing and controlling one or more connected tone generators or other devices (such as a computer/sequencer).
Song	With this setting, only the Song channels 1 – 16 are transmitted from this instrument via the corresponding channel numbers 1 – 16 respectively. This is used to play Song data with an external tone generator and to record Song data to an external sequencer.
Clock Ext (Clock External)	Playback or recording (Song, Style, etc.) synchronizes with an external MIDI clock instead of the instrument’s internal clock. This template should be used when you wish to set the tempo on the MIDI device connected to the instrument.
MIDI Accord1 (MIDI Accordion 1)	MIDI accordions allow you to transmit MIDI data and play connected tone generators from the keyboard and bass/chord buttons of the accordion. This template lets you control the keyboard performance and Style playback from a MIDI Accordion.
MIDI Accord2 (MIDI Accordion 2)	Basically the same as “MIDI Accord1” above, with the exception that the chord/bass notes you play with your left hand on a MIDI Accordion are recognized also as MIDI note events.
MIDI Pedal1	MIDI pedal units allow you play connected tone generators with your feet (especially convenient for playing single note bass parts). This template lets you play/control the chord root in Style playback with a MIDI pedal unit.
MIDI Pedal2	This template lets you play the bass part for Style playback by using a MIDI pedal unit.
MIDI OFF	No MIDI signals are sent or received.

System – MIDI System Related Settings

The explanations here apply when you call up “System” display in step 2 on [page 96](#).

Clock	<p>Determines whether the instrument is controlled by its own internal clock (“Internal”) or a MIDI clock (“MIDI,” “USB1,” “USB2,” and “Wireless LAN”) received from an external device. “Internal” is the normal Clock setting when the instrument is being used alone or as a master keyboard to control external devices. If you are using the instrument with an external sequencer, MIDI computer, or other MIDI device, and you want to synchronize it to that device, set this parameter to the appropriate setting: “MIDI,” “USB 1,” “USB 2,” or “Wireless LAN.” In this case, make sure that the external device is connected properly (e.g., to the instrument’s MIDI IN terminal), and that it is properly transmitting a MIDI clock signal. When this is set for control by an external device (“MIDI,” “USB1,” “USB2,” or “Wireless LAN”), the Tempo is indicated as “Ext.” in the Tempo display.</p> <p>NOTE If the Clock is set other than “Internal,” the Style, Song, Metronome and Tempo cannot be controlled by the buttons on this instrument.</p> <p>NOTE “Wireless LAN” is shown only when the USB Wireless LAN adaptor (UD-WL01) is connected to this instrument.</p>
Transmit Clock	Turns MIDI clock (F8) transmission on or off. When set to “Off,” no MIDI clock or Start/Stop data is transmitted even if a Song or Style is played back.
Transpose MIDI Input	Determines whether or not the instrument’s transpose setting is applied to the note events received from the external device via MIDI.
Start/Stop	Determines whether incoming FA (start) and FC (stop) messages affect Song or Style playback.

Local Control		Turns the Local Control for each part on or off. When Local Control is set to “On,” the keyboard of the instrument controls its own (local) internal tone generator, allowing the internal Voices to be played directly from the keyboard. If you set Local Control to “Off,” the keyboard and controllers are internally disconnected from the instrument’s tone generator section so that no sound is output when you play the keyboard or use the controllers. For example, this allows you to use an external MIDI sequencer to play the instrument’s internal Voices, and use the instrument keyboard to record notes to the external sequencer and/or play an external tone generator.
System Exclusive Message	Transmit	Determines whether MIDI System Exclusive messages are transmitted (On) or not (Off) from this instrument.
	Receive	Determines whether MIDI System Exclusive messages are recognized (On) or not (Off) by this instrument.
Chord System Exclusive Message	Transmit	Determines whether MIDI chord system exclusive data (Chord Detect: root and type) are transmitted (On) or not (Off) from this instrument.
	Receive	Determines whether MIDI chord system exclusive data (Chord Detect: root and type) are recognized (On) or not (Off) by this instrument.

Transmit – MIDI Transmit Channel Settings

The explanations here apply when you call up the “Transmit” display in step 2 on [page 96](#). This determines which MIDI channel is used for each part when MIDI data is transmitted from this instrument.

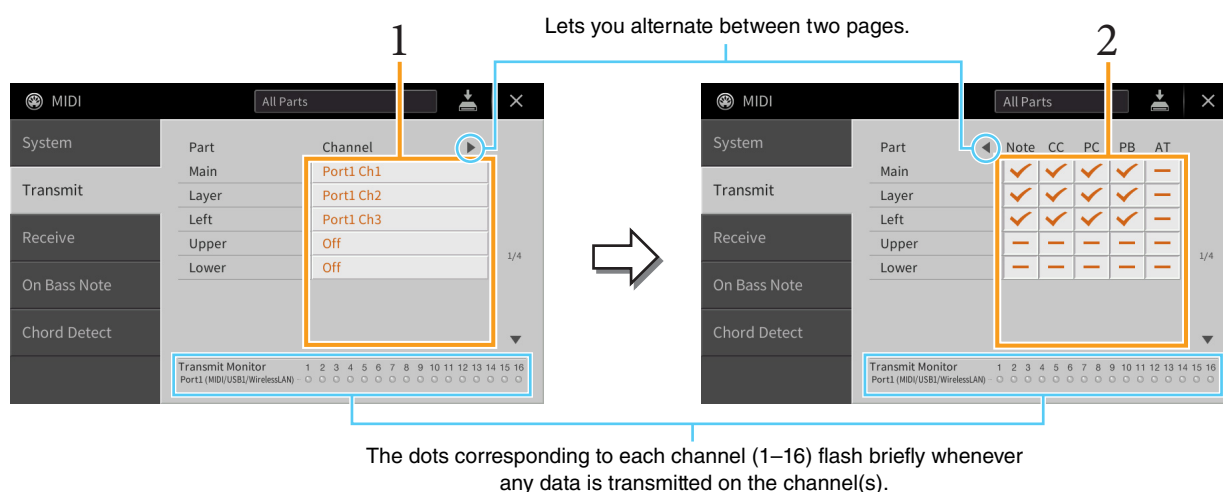

1 For each Part, select the MIDI Transmit Channel with which the MIDI data of the corresponding Part is to be transmitted.

With the exception of the two parts below, the configuration of the parts is the same as those already explained elsewhere in the Owner’s Manual.

- **Upper:** A keyboard part played on the right side of the keyboard from the Left Split Point.
- **Lower:** A keyboard part played on the left side of the keyboard from the Left Split Point. This is not affected by the on/off status of the [ACMP ON/OFF] button.

NOTE If the same transmit channel is assigned to several different parts, the transmitted MIDI messages are merged to a single channel — resulting in unexpected sounds and possible glitches in the connected MIDI device.

NOTE Protected Songs cannot be transmitted even if the proper Song channels 1 – 16 are set to be transmitted.

2 Touch [▶] to call up the other page then select which MIDI messages are to be transmitted for each Part.

The following MIDI messages can be set on the Transmit/Receive display.

- **Note (Note events)** page 74
- **CC (Control Change)**..... page 74
- **PC (Program Change)**..... page 74
- **PB (Pitch Bend)** page 74
- **AT (Aftertouch)** page 74

Receive – MIDI Receive Channel Settings

The explanations here apply when you call up the “Receive” display in step 2 on page 96. This determines which Part is used for each MIDI channel when the MIDI data is recognized by this instrument.

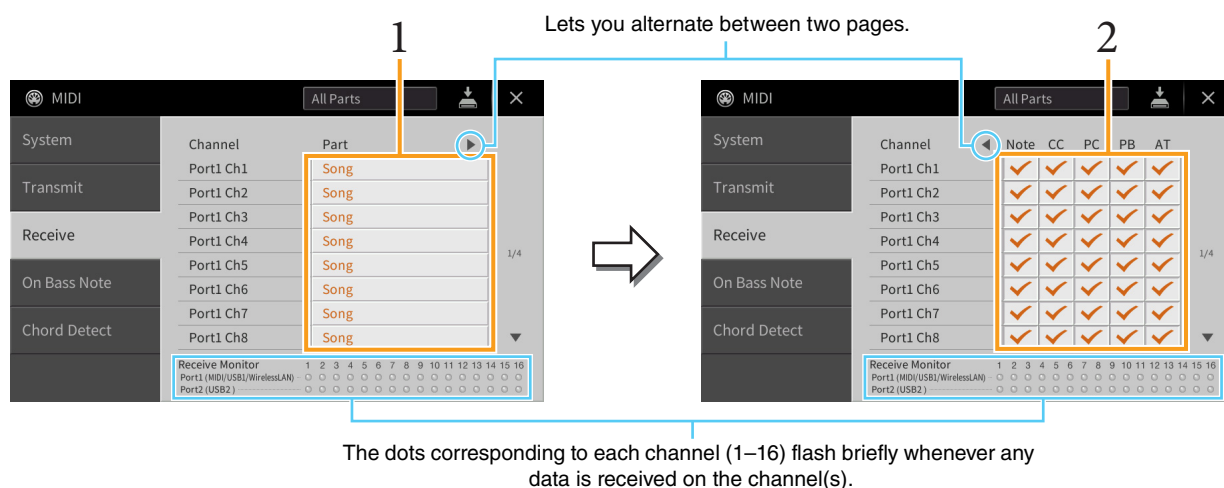

1 For each Channel, select the Part which is to handle the MIDI data of the corresponding channel received from the external MIDI device.

When connecting via USB, MIDI data of 32 channels (16 channels x 2 Ports) can be handled by this instrument. With the exception of the two parts below, the configuration of the parts is the same as those already explained elsewhere in the Owner’s Manual.

- **Keyboard:** The received note messages control the instrument’s keyboard performance.
- **Extra Part 1 – 5:** These five parts are specially reserved for receiving and playing MIDI data. Normally, these parts are not used by the instrument itself.

2 Touch [▶] to call up the other page then select which MIDI messages are to be received for each Channel.

MIDI transmission/reception via the USB terminal, Wireless LAN, and MIDI terminals

The relationship between the MIDI terminals, Wireless LAN and the [USB TO HOST] terminal which can be used for transmitting/receiving 32 channels (16 channels x 2 ports) of the MIDI messages is as follows:

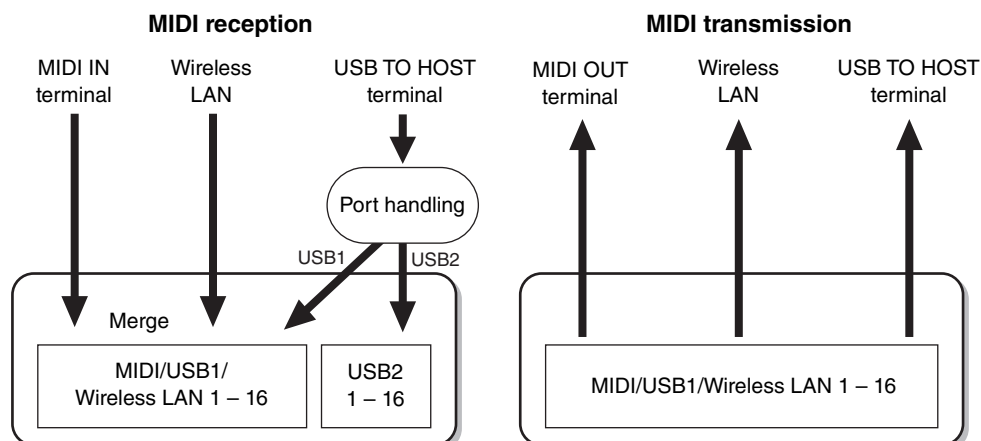

On Bass Note – Setting the Bass Note for Style Playback

The explanations here apply when you call up “On Bass Note” display in step 2 on [page 96](#). The settings here let you determine the bass note for Style playback, based on the note messages received via MIDI. The note on/off messages received at the channel(s) set on are recognized as the bass notes of the chords for Style playback. The bass note will be detected regardless of the [ACMP ON/OFF] or Split Point settings. When several channels are simultaneously set on, the bass note is detected from merged MIDI data received over the channels.

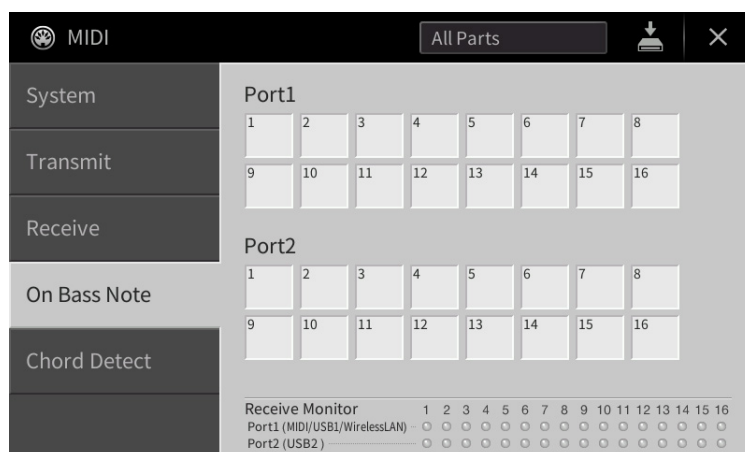

Touch the desired channel number to enter the checkmark. Touch the same location again to remove the checkmark.

Chord Detect – Setting the Chord Type for Style Playback

The explanations here apply when you call up “Chord Detect” display in step 2 on [page 96](#). The settings here let you determine the chord type for Style playback, based on the note messages received via MIDI. The note on/off messages received at the channel(s) set to on are recognized as the notes for detecting chords in Style playback. The chords to be detected depend on the fingering type. The chord types will be detected regardless of the [ACMP ON/OFF] or split point settings. When several channels are simultaneously set to on, the chord type is detected from merged MIDI data received over the channels.

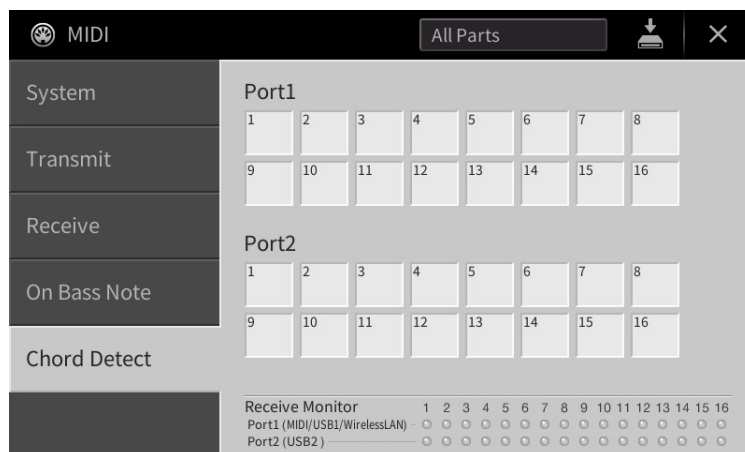

Touch the desired channel number to enter the checkmark. Touch the same location again to remove the checkmark.



Utility

Making Global Settings (Utility)

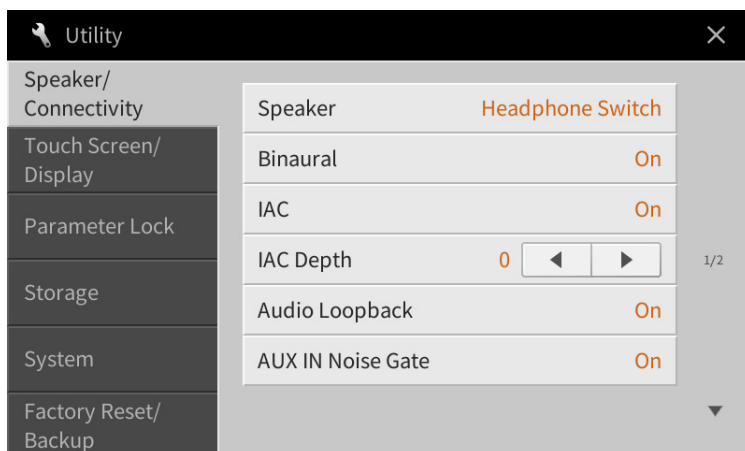

Speaker/Connectivity

Speaker	<p>Determines how the sound is output from the speaker of this instrument.</p> <ul style="list-style-type: none">• Headphone Switch: Speaker sounds normally, but is cut off when headphones are inserted to the [PHONES] jack.• On: Speaker sound is always on.• Off: Speaker sound is off. You can only hear the instrument sound via the headphones or an external device connected to the AUX OUT jacks.
Binaural	<p>Turns the Binaural Sampling function or the Stereophonic Optimizer function for VRM Voices on or off.</p> <p>When the function is on and headphones are connected to the [PHONES] jack, the sound from the headphones is affected by these functions. However, when headphones are connected, these functions also affect the sound from the external speaker connected to the AUX OUT jacks or the sound for Audio recording (by using the Bluetooth Audio function or USB Audio Interface function), and may result unusual or unnatural sound. If this happens, turn this function off.</p> <p>For details about Binaural Sampling and Stereophonic Optimizer, refer to “Using Headphones” in the “Starting Up” section of the Owner’s Manual.</p> <p>NOTE If the “Speaker” setting above is “On,” the effect is not applied even when “Binaural” is set to on.</p>
IAC	<p>Turns on or off the IAC (Intelligent Acoustic Control). With this function, the sound quality of this instrument is automatically adjusted and controlled according to the overall volume. Even when the volume is low, this lets you hear both low sounds and high sounds clearly.</p>
IAC Depth	<p>Adjusts the IAC depth.</p>
Audio Loopback	<p>Determines whether audio input from the connected computer or smart device is output to a computer or a smart device or not. For details, refer to the Owner’s Manual, Chapter 10.</p>
AUX IN Noise Gate	<p>Turns on or off the Noise Gate which minimizes noise of the sound input via the [AUX IN] jack.</p>

Display Out	Content	<p>Determines the video content which is output to a connected external monitor, such as a television.</p> <ul style="list-style-type: none"> • Lyrics/Text: Only the lyrics of the Song or text files (whichever you used last time) are output, regardless of the display that is called up on the instrument. • LCD: The currently selected display is output.
--------------------	----------------	---

Touch Screen/Display

Page 1/2

For information about this display, refer to “Changing the Brightness of Display” in the “Starting Up” section of the Owner’s Manual.

Page 2/2

Display	Home Theme	Touch and change the theme (background) of the Home display. The available settings are Piano/White/Black.
	Time Stamp	<p>Determines whether the time stamp of a file is shown on the User tab of the File Selection display or not.</p> <p>NOTE When the instrument is connected to a network via the USB wireless LAN adaptor (UD-WL01), the current time is taken from the network and displayed. For details, refer to page 110.</p>
	Voice Number	Determines whether or not the Voice bank and number are shown in the Voice Selection display. This is useful when you want to check which bank select MSB/LSB values and program change number you need to specify when selecting the Voice from an external MIDI device.
	Pop-up Display Time	Determines the time that elapses before the pop-up windows close. Pop-up windows appear when you press buttons TEMPO [-]/[+], TRANSPOSE [-]/[+], SONG CONTROL [◀◀](REW)/[▶▶](FF), or REGISTRATION BANK [-]/[+]. When “Hold” is selected here, the pop-up window is shown until you touch [X].
	Transition Effect	<p>Turns on or off the Transition Effect which is applied when the display is changed.</p> <p>NOTE Transition effects on the instrument’s display cannot be output.</p>
	Voice Area	Determines which keyboard parts are shown in the Voice area of the Home display. When “Show Active Parts Only” is selected, only the active keyboard parts are shown. When “Show All Parts” is selected, all the keyboard parts are shown.

Parameter Lock

This function is used to “lock” specific parameters (effect, split point, etc.) to make them selectable only via the panel control — in other words, instead of being changed via Registration Memory, One Touch Setting, Music Finder, or Song and sequence data.

To lock the desired parameter, touch the corresponding box to enter the checkmark. To unlock the parameter, touch the box again.

Storage

This lets you execute the Format operation or check the memory capacity (approximate value) of the User memory or the connected USB flash drive.

The User memory is indicated as “USER,” and the USB flash drives are indicated as “USB 1” or “USB 2,” depending on the number of the connected devices.

To format the drive, select the drive and then touch [Format].

NOTICE

The format operation overwrites any previously existing data. Make sure that the drive you are formatting does not contain important data. Proceed with caution.

System

Page 1/2

For information about this display, refer to “Making the Basic Settings” in the “Starting Up” section of the Owner’s Manual.

Page 2/2

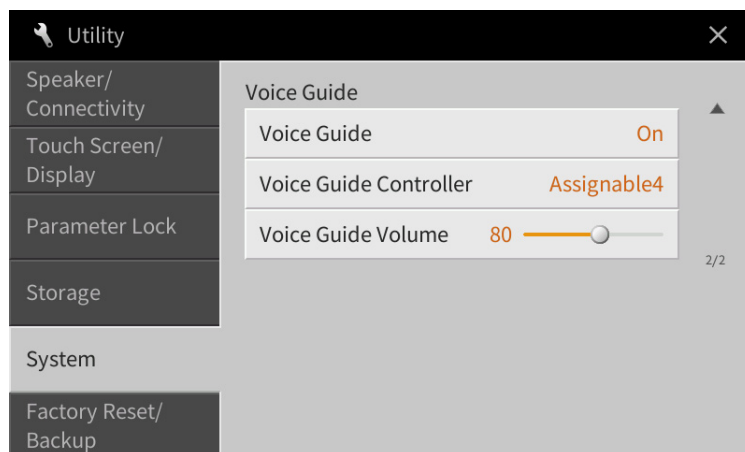

Voice Guide	Determines whether or not Voice Guide is used (On/Off), when USB flash drive containing the Voice Guide (audio) file is properly connected to this instrument. This setting can also be changed by pressing and holding the [DEMO] button for longer than three seconds.
Voice Guide Controller	By holding the controller set here and then pressing the panel button or touching the item on the display, you can hear the corresponding name (with no execution of the function).
Voice Guide Volume	Adjusts the volume of Voice Guide.

To use Voice Guide, you need to download the Voice Guide (audio) file from the Yamaha website, and save it to USB flash drive, which you then connect to this instrument. For information on using Voice Guide, refer to the Voice Guide Tutorial Manual (simple text file).

The Voice Guide (audio) file and the Voice Guide Tutorial Manual are available via the following URL:

<https://download.yamaha.com/>

Factory Reset/Backup

Factory Reset — Restoring the Factory Programmed Settings

On page 1/2, checkmark the boxes of the desired parameters then touch [Factory Reset] to initialize the settings of the parameters which are checkmarked.

System	Restores the System Setup parameters to the original factory settings. Refer to “Parameter Chart” in the Data List (separate PDF) for details about which parameters belong to the System Setup.
MIDI	Restores the MIDI settings including the MIDI templates saved in the internal User memory to the original factory status.
User Effect	Restores the User Effect settings including the following data to the original factory settings. <ul style="list-style-type: none"> • User Effect types (page 13) • User Master EQ types (page 12) • User Master Compressor types (page 16) • User Vocal Harmony types (page 32) • User Microphone Settings (page 27)
Registration	Turns off all the REGISTRATION MEMORY [1] – [8] lamps, indicating that no Registration Memory Bank is selected although all the Bank files are maintained. In this status, you can create Registration Memory setups from the current panel settings.
Favorite	Removes all files from the Favorite tab on the Voice Selection display and the Style Selection display.

NOTE If you want to delete all data in the User memory, format the memory via [Menu] → [Utility] → [Storage] (page 104).

Backup/Restore – Saving and Recalling Your Original Settings as a Single File –

For the items below, you can save your original settings to the internal User memory or USB flash drive as a single file for future recall.

- 1 Make all desired settings on the instrument, then call up page 2/2 of the “Factory Reset/Backup” display.**
- 2 As necessary, connect a USB flash drive to the [USB TO DEVICE] terminal.**
If you want to save all settings, you can only use the USB flash drive to save the data.
- 3 Touch [Backup] or [Save] of the desired item to save the data.**

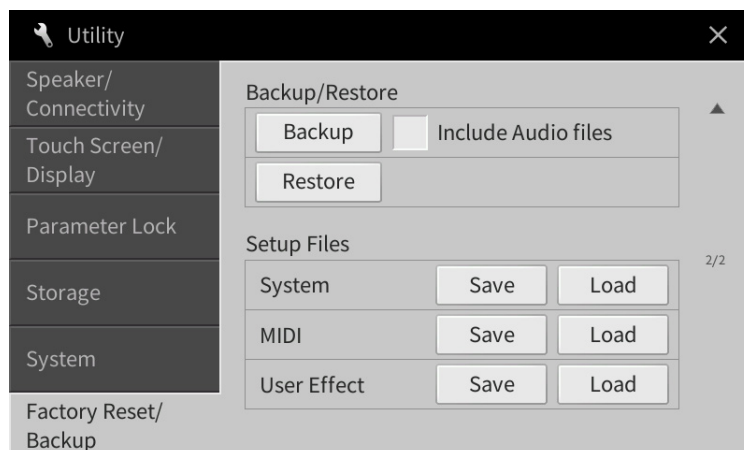

■ Backup/Restore

All settings and data in the User memory of this instrument (except for protected Song) are saved to the USB flash drive as a single file named “CVP-809.bup” or “CVP-805.bup.”

If you want to contain the Audio Songs (WAV/MP3) saved to the User memory in the same file, enter the checkmark to the “Include Audio Files” box. If you do not want to save the Audio files because of the large data size, remove the checkmark.

■ Setup Files

The following settings are saved as a file individually.

Select the desired destination to save the file, and then touch [Save here]. You can change the file name as necessary.

System	Parameters set on the various displays such as “Utility” are handled as a single System Setup file. Refer to “Parameter Chart” in the Data List (separate PDF) for details on which parameters belong to System Setup.
MIDI	The MIDI settings including the MIDI templates on the internal User memory are handled as a single MIDI Setup file.
User Effect	The User Effect settings including the following data can be managed as a single file. <ul style="list-style-type: none"> • User Effect types (page 13) • User Master EQ types (page 12) • User Master Compressor types (page 16) • User Vocal Harmony types (page 32) • User Microphone Settings (page 27)

To call up the saved data:

Touch [Restore] or [Load] of the desired item, then select the desired file.

If you want to restore the factory programmed settings, select the setup file in the “Preset” tab.

NOTICE

- Files including Protected Songs in the User memory of the instrument are replaced by restoring the backup file. Move or copy the files in the User memory of the instrument to USB flash drive before restoring.
- Completing the backup/restore operation may take a few minutes. Do not turn off the power during backup or restoring. If you turn off the power during backup or restoring, data may be lost or damaged.



Connecting to a Bluetooth-equipped Device

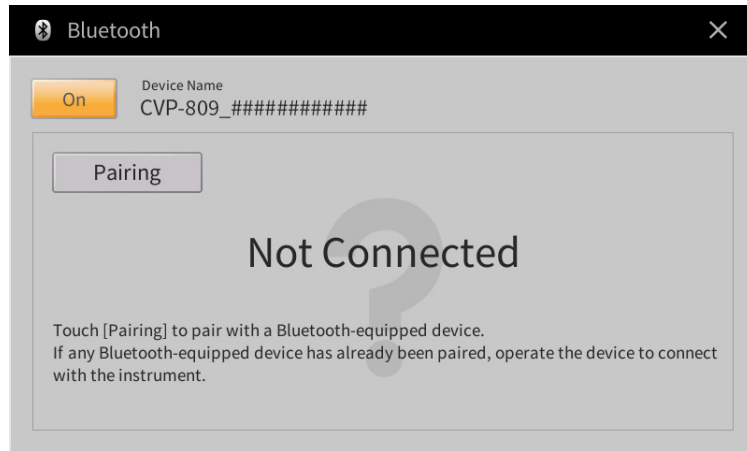

For information about this display, refer to the Owner's Manual, Chapter 10.



Wireless LAN Settings

This icon is shown only when the USB Wireless LAN adaptor (UD-WL01) is connected to the [USB TO DEVICE] terminal. Make sure the adaptor is connected before executing any operations.

This instrument can be connected to a smart device via wireless LAN. For general operating instructions, refer to the “Smart Device Connection Manual” (separate PDF). This section covers only operations that are specific to this instrument.

When the connection is done successfully, “Connected” is shown at the top of the display, and one of the icons shown below appears indicating the signal strength.



Infrastructure Mode

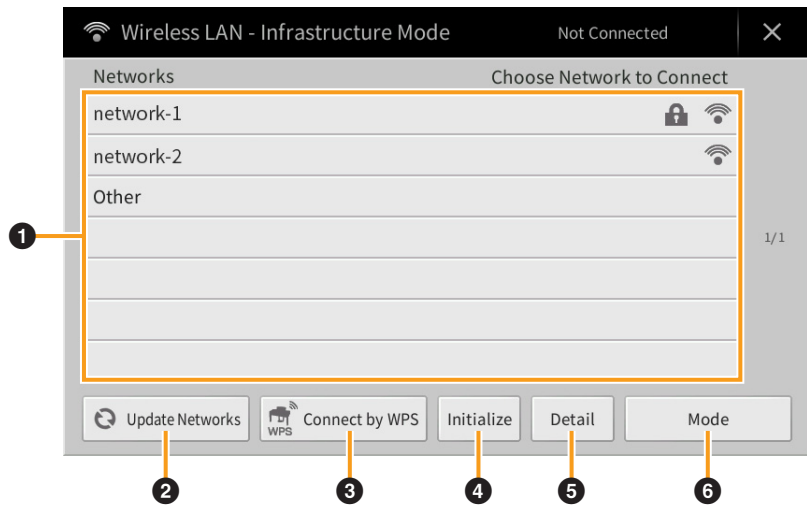

<p>1</p>	<p>Networks</p>	<p>Connecting to a network listed on the display: From the Networks listed on the display, select the desired one. For a network having a lock icon (), you need to enter the password and touch [Connect]; for a network without a lock icon, you can connect the network only by selecting it.</p> <p>Manual Setup: Touch [Other] displayed at the very end of the list to call up the Manual Setup display, for making SSID, security, and password settings. After entering them, touch [Connect] on the Manual Setup display to connect to the network.</p>
<p>2</p>	<p>Update Networks</p>	<p>Updates the Network List on the display.</p>
<p>3</p>	<p>Connect by WPS</p>	<p>Connects this instrument to the network via WPS. After touching [Start WPS] in the window appeared by touching here, press the WPS button of the desired wireless LAN access point within two minutes.</p> <p>NOTE Make sure that your access point supports WPS. About the confirmation and changes in the access point settings, refer to the manual of the access point.</p>
<p>4</p>	<p>Initialize</p>	<p>Initializes the connection setup to the default factory status.</p>

5	Detail	Lets you set detailed parameters such as the static IP address. After setting, touch [OK].
6	Mode	Switches to the Access Point Mode.

Access Point Mode

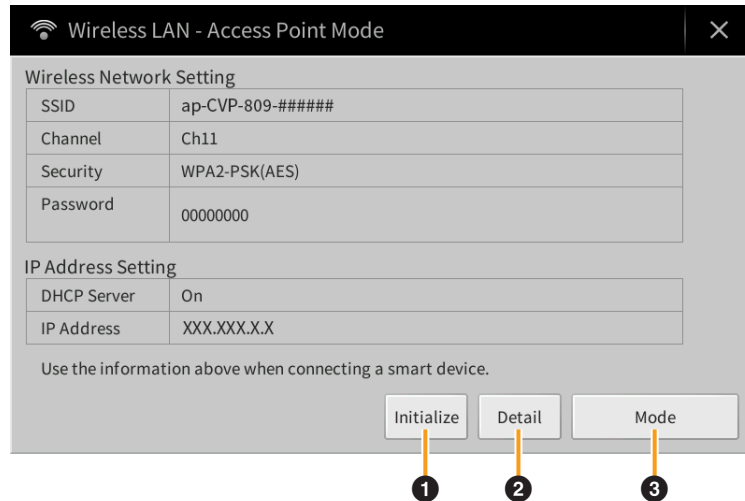

1	Initialize	Initializes the connection setup to the default factory status.
2	Detail	Sets the detailed parameters. <ul style="list-style-type: none"> • 1/3 page: Sets the SSID, security, password, and channel. • 2/3 page: Sets the IP address and other related parameters. • 3/3 page: Enters the Host name or shows MAC address, etc.
3	Mode	Switches to the Infrastructure Mode.

14:38



Time

Making the Time Settings

This icon is shown only when the USB Wireless LAN adaptor (UD-WL01) is connected to the [USB TO DEVICE] terminal. Make sure the adaptor is connected before executing any operations.

When the instrument is connected to a network and the current time is retrieved from the network successfully, the current time is displayed above the icon. Make sure to connect by Infrastructure Mode. For details on the connections, refer to the “Smart Device Connection Manual” (separate PDF).

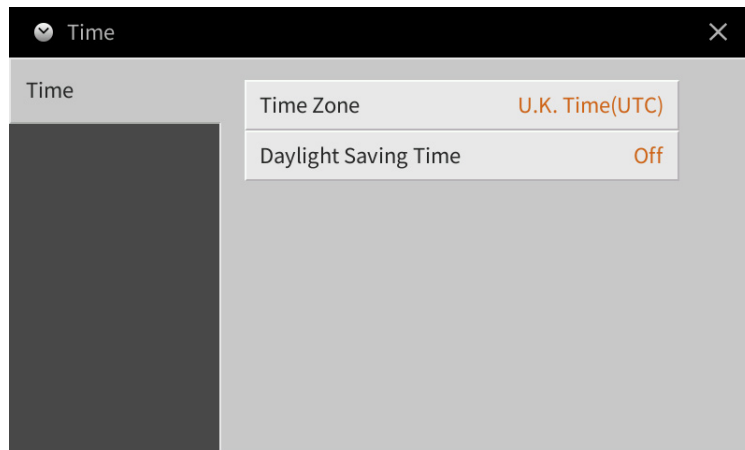

Time Zone	Touch to select the Time Zone.
Daylight Saving Time	Touch to turn daylight-saving time on or off.

NOTE When the instrument cannot retrieve the current time from the network, the time displayed will not be correct.

Index

Numerics

3 Band EQ 26

A

Access Point Mode 109

Amplitude 50

Any Key 87

Articulation 44

Assembly 59

Assignable 46

Attack 49

Attenuator 27

Audio File Format 91

Audio Loopback 102

Audio Rec Format 91

B

Backup 105

Balance 9, 10

Bar Clear 61

Bar Copy 61

Bass Hold 45

Beat Converter 60

Binaural 102

Block Diagram 17

Bluetooth 107

Brightness 10, 49

Bypass 64

C

Channel Edit 60, 76

Chord 19

Chord Cancel 7

Chord Detect 89, 101

Chord Detection Area 7

Chord Looper 38

Chord Source 29

Chord Tutor 8

Chordal 29

Chorus 14

Clock 68, 71, 75, 97

Color 19

Compression 16

Compressor 15, 26

Cutoff frequency 49

D

Decay 49

Display 103

Dorian 64

Drums 82

Dynamics 61

Dynamics Control 84

E

Each Key Setting 80

Echo 25

Effect 12, 50

EG (Envelope Generator) 49

EQ (Equalizer) 11

Equalizer 11

Event Filter 75

Event List 68, 71, 74

Expand 74

F

Factory Reset 105

Fade In/Out 45

Filter 10, 49

Fingering Type 6

Follow Lights 87

Footage 51

G

Glide 44

GM Voice 83

Groove 60

Guide 18, 87

Guitar 63

H

Harmonic Cont. 49

Harmonic Content 10, 49

Harmonic Minor 64

Harmony Assign 31

Harmony note 30

Harmony Type 24

High Key 65

I

IAC (Intelligent Acoustic Control) 102

Infrastructure Mode 108

Insertion Effect 12, 13, 50

J

Jump 88

K

Karao-Key 87

Key Signature 19

Keyboard Harmony 24

L

Lead note 30

Left Hold On/Off 46

LFO Amplitude 50

LFO Filter 50

LFO Pitch 50

Local Control 98

Loop Recording 56

Lyrics 19, 20

M

Manual Bass 7

Manual Setup 108

Master Compressor 15

Master EQ 11

Master Tune 92

MegaVoice 82, 83

Melodic Minor 64

Metronome 95

Microphone 26

MIDI 96

MIDI Accordion 97

MIDI Pedal 97

MIDI Receive Channel 99

MIDI reception 100

MIDI Template 96

MIDI transmission 100

MIDI Transmit Channel 98

Mixer 10

Modulation 44, 49, 50

Mono 46, 48

Mono Type 48

MP3 91

Multi Assign 25

Music Notation 18

N

Natural Minor 64

Network 108

Noise Gate 26

Note 19

Note Limit 65

Note Name 19

NTR (Note Transposition Rule) ... 63

NTT (Note Transposition Table) ..	64
O	
Octave	78
On Bass Note	100
Organ Flutes	51, 82
Original Beat	60
OTS Link Timing	85
Output	16
Overdub Recording	56
P	
Pan	15
Parameter Lock	103
Part EQ	11
Pattern Length	55
Pedal	43
Performance Assistant	89
Phrase Mark Repeat	88
Pitch Bend	44
Pitch Bend Range	78
Pitch Detect	27
Pitch Shift	65
Play Root/Chord	63
Playlist	33
Poly	46, 48
Portamento	44
Portamento Time	48, 78
Punch In/Out	89, 90, 91
Q	
Quantize	19, 61, 76, 77
Quick Start	88
R	
Ratio	26
Realtime Recording	56, 66
Registration Freeze	37
Registration Memory	35
Registration Sequence	35
Release	49
Repeat Mode	88
Resonance	49
Restore	105
Retrigger	65
Reverb	14
Root Fixed	63
Root Trans (Root Transpose)	63
Rotary Speaker	51
RTR (Retrigger Rule)	65
S	
Scale Tune	92

Scale type	93
Score	18
Scrub	88
SFF Edit	62
SFX	82
Shortcut	3
Soft	44
Song	87
Song Creator	66
Song Position	68, 71, 75
Sostenuto	44
Source Pattern	53
Source Root/Chord	63
Speaker	102
Split Point	6, 24
Step Recording	59, 66
Stop ACMP	84
Stroke	64
Style	84
Style Characteristics	86
Style Creator	53
Style File Format	62
Sustain	44
Swing	60
Synchro Stop Window	85
System Effect	12
T	
Talk	26, 28
Talk Mixing	27
Tap Tempo	95
Temperament	92
Tempo	4
Text	22
Texture	16
Threshold (Th.)	26
Time	110
Time Signature	95
Time Stamp	103
Touch Screen	103
Touch Sensitivity	48, 94
Touch Sensitivity Depth	48
Touch Sensitivity Offset	48
Transpose	5, 77
Tremolo	25
Trill	25
Tuning	78, 92
U	
User Effect	105, 106
Utility	102

V	
Variation Effect	12, 13
Vibe Rotor	44
Vibrato	49
Vocal Harmony	28
Vocoder	29
Vocoder-Mono	29
Voice	78
Voice Characteristics	81
Voice Edit	47, 51
Voice Guide	104
Volume	15
VRM	81
W	
WAV	91
Wireless LAN	108
WPS	108
X	
XG Voice	83
Y	
Your Tempo	87