

Synthesizer Parameter Manual

Introduction

This manual explains the parameters and technical terms that are used for synthesizers incorporating the Yamaha AWM2 tone generators and the FM-X tone generators. You should use this manual together with the documentation unique to the product. Read the documentation first and use this parameter manual to learn more about parameters and terms that relate to Yamaha synthesizers. We hope that this manual gives you a detailed and comprehensive understanding of Yamaha synthesizers.

Information

The contents of this manual and the copyrights thereof are under exclusive ownership by Yamaha Corporation.

The company names and product names in this manual are the trademarks or registered trademarks of their respective companies.

Some functions and parameters in this manual may not be provided in your product. The information in this manual is current as of September 2018.

Table Of Contents

1	Part Parameters	4
1-1	Basic Terms	4
1-1-1	Definitions	4
1-2	Synthesis Parameters	7
1-2-1	Oscillator	7
1-2-2	Pitch	10
1-2-3	Pitch EG (Pitch Envelope Generator)	12
1-2-4	Filter Type	17
1-2-5	Filter	23
1-2-6	Filter EG (Filter Envelope Generator)	25
1-2-7	Filter Scale	29
1-2-8	Amplitude	30
1-2-9	Amplitude EG (Amplitude Envelope Generator)	33
1-2-10	Amplitude Scale	37
1-2-11	LFO (Low-Frequency Oscillator)	39
1-3	Operational Parameters	45
1-3-1	General	45
1-3-2	Part Setting	45
1-3-3	Portamento	46
1-3-4	Micro Tuning List	47
1-3-5	Arpeggio	48
1-3-6	Motion Sequencer	51
1-3-7	Controller Set	53
1-3-8	Effect	56
1-3-9	EQ (Equalizer)	58
1-3-10	Envelope Follower	59
2	Effects	60
2-1	Basic Terms	60
2-1-1	Definitions	60
2-2	Effect Types	60
2-2-1	Reverb	60
2-2-2	Delay	61
2-2-3	Chorus	61
2-2-4	Flanger	61
2-2-5	Phaser	62
2-2-6	Tremolo & Rotary	62
2-2-7	Distortion	62
2-2-8	Compressor	63
2-2-9	Wah	64
2-2-10	Lo-Fi	64
2-2-11	Tech	65
2-2-12	Misc	66

2-3	Effect Parameters	67
2-3-1	A	67
2-3-2	B	67
2-3-3	C	68
2-3-4	D	69
2-3-5	E	70
2-3-6	F	71
2-3-7	G	72
2-3-8	H	72
2-3-9	I	73
2-3-10	K	73
2-3-11	L	74
2-3-12	M	75
2-3-13	N	76
2-3-14	O	77
2-3-15	P	77
2-3-16	R	78
2-3-17	S	79
2-3-18	T	80
2-3-19	U	81
2-3-20	V	81
2-3-21	W	81
3	MIDI	82
3-1	Overview	82
3-1-1	About MIDI	82
3-1-2	MIDI channels	82
3-1-3	MIDI ports	83
3-1-4	MIDI messages	83
3-2	Channel Messages	84
3-2-1	Note On/Off	84
3-2-2	Pitch Bend	84
3-2-3	Program Change	84
3-2-4	Control Change	84
3-2-5	Channel Mode message	87
3-2-6	Channel After Touch	88
3-2-7	Polyphonic After Touch	88
3-3	System Messages	89
3-3-1	System Exclusive Messages	89
3-3-2	System Realtime Messages	89

1 Part Parameters

1-1 Basic Terms

1-1-1 Definitions

Part	<p>A Part is a musical instrument sound that is built into an Electronic Musical Instrument.</p> <p>There are three Part Types:</p> <ul style="list-style-type: none"> ■ Normal Parts (AWM2) ■ Normal Parts (FM-X) ■ Drum Parts
Normal Part (AWM2)	<p>Normal Parts (AWM2) are mainly pitched musical instrument-type sounds such as Piano, Organ, Guitar, and Synthesizer. You can play over the range of the keyboard at the standard pitch for each key.</p> <p>Normal Parts (AWM2) consist of multiple Elements (see "Element").</p>
Normal Part (FM-X)	<p>Normal Parts (FM-X) are mainly pitched musical instrument-type sounds created by an FM-X tone generator. You can play over the range of the keyboard at the standard pitch for each key.</p> <p>Normal Parts (FM-X) consist of multiple Operators by which fundamental waveforms are produced (see "Operator").</p>
Drum Part	<p>Drum Parts are mainly percussion/drum sounds.</p> <p>A Drum Part consists of mainly percussion/drum sounds that are assigned to individual notes on the keyboard, or a collection of assigned percussion/drum waves. The Drum Part is also known as a Drum Kit.</p>

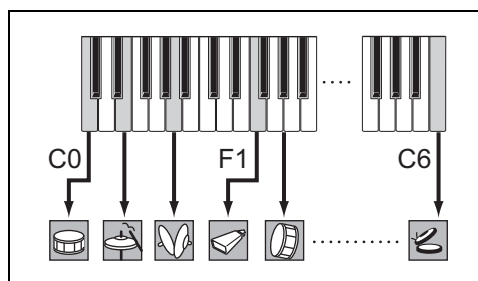

Figure 1: Individual drum sounds, different for each key.

Element	<p>An Element is the smallest unit that makes up a Normal Part (AWM2). An Element is created by applying Part Parameters to sound material. A single Normal Part (AWM2) can be created by combining several Elements.</p>
Operator	<p>An Operator is a device for creating sound fundamental waveforms for Normal Part (FM-X).</p> <p>A sound for a Normal Part (FM-X) is created by modulating a frequency of a fundamental waveform with another waveform.</p> <p>An operator that generates a fundamental waveform is a "carrier," and an operator that modulates these waveforms is a "modulator." Each of the multiple operators will be used as a carrier or a modulator depending on the algorithm.</p>

Algorithm

The combination of a number of Operators is called an "Algorithm." When the waveform output from the Operator is a simple sine wave, no harmonics are included other than the fundamental tone. However, you can create harmonics by modulating the waveform with other Operators. How harmonics can be created depends on the Modulators' output levels and the frequency rates of Carriers and Modulators. On the other hand, the basic pitch is determined by Carrier's frequency, and the output level is determined by the Carrier's output level. The figure described below shows a basic way to create FM sound by using an analog synthesizer.

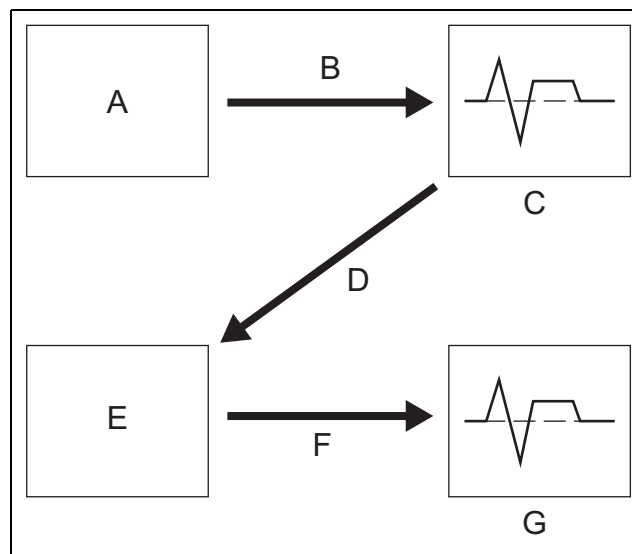

Figure 2: A basic way to create FM sound by using two operators.

- A:** Modulator OP: Frequency ratio of the Modulator and the Carrier determines the base waveform including specific harmonics by the Oscillator.
- B:** Modulator output level determines the Cutoff Frequency of the Filter.
- C:** Modulator envelope determines the Filter envelope.
- D:** Modulation
- E:** Carrier OP: Carrier Frequency determines the pitch of the Oscillator.
- F:** Carrier output level determines the volume by using the amplifier.
- G:** Carrier envelope determines the amplifier envelope.

Feedback

Waveforms can be changed by feeding some of the signal generated by an operator back through that operator. This is called "Feedback."

Drum Key

A Drum Key is the smallest unit that makes up a Drum Part. A Drum Key is assigned to individual notes on the Keyboard. The percussion or drum wave is assigned to a Drum Key.

Part Edit	<p>A function that lets you create your own Parts. Use Part Edit to adjust or apply Part Parameters to a Part.</p> <p>For Normal Parts (AWM2):</p> <ul style="list-style-type: none">■ Use Element Common Edit to edit the settings that are common to all Elements;■ Use Element Edit to edit the settings for each Element separately. <p>For Normal Parts (FM-X):</p> <ul style="list-style-type: none">■ Use Operator Common Edit to edit the settings that are common to all Operators;■ Operator Edit to edit the settings for each Operator separately. <p>For Drum Parts:</p> <ul style="list-style-type: none">■ Use Key Common Edit to edit the settings that are common to all keys;■ Use Key Edit to edit the settings for each key separately.
GM	<p>General MIDI (GM) is a worldwide standard for voice organization and MIDI functions of synthesizers and tone generators.</p> <p>This standard ensures that any song sounds virtually the same on any GM device of any manufacturer. The GM Bank on this synthesizer is designed to appropriately play back GM song data. However, the sound may not be exactly the same as played by the original tone generator.</p>

1-2 Synthesis Parameters

1-2-1 Oscillator

An Oscillator is one unit of the tone generator block of the Electronic Musical Instrument to control the waveform and Operators.

Key On Delay Tempo Sync	Determines if the Key On Delay (the time delay between when a key is pressed and the corresponding sound is actually played) is synchronized to the tempo of the Arpeggio or phrase.
Key On Delay Note Length	Determines the timing of the Key On Delay when the Delay Tempo Sync is set to On. On the other hand, there is another parameter called "Key On Delay Length." The parameter determines the timing of the Key On Delay when the Delay Tempo Sync is set to Off.
Velocity Limit	Determines the minimum and maximum Velocity values within which an Element responds. Each Element will only sound for notes played between its specified Velocity Limits. For example, this lets you have one Element sound when you play softly and have a different one sound when you play strongly. If you first specify the maximum value and then the minimum value, for example "93 to 34," then the Velocity range covers both "1 to 34" and "93 to 127," with a Velocity "hole" between 34 and 93.
Velocity Cross Fade	Determines how gradually the volume of an Element decreases in proportion to the distance of Velocity changes outside the Velocity Limit setting. <ul style="list-style-type: none"> ■ The higher the value, the more gradually the volume decreases. ■ 0: No sound outside the Velocity Limit (see "Velocity Limit") is produced.
Note Limit	Determines the lowest and highest notes of the keyboard range for an Element. The selected Element will sound only when you play notes within this range. If you first specify the highest note and then the lowest note, for example "C5 to C4," then the note range covers both "C-2 to C4" and "C5 to G8," with no sound for the Element between C4 and C5.
Element Switch	Switches a selected Element On or Off. Elements for which the Element Switch is switched off will not sound.
Bank	Indicates the Waveform Bank of an Element or Drum Key (Drum Part).
Waveform Category and Number	Indicates a waveform category and a waveform number of an Element or Drum Key. The waveform is specified by selecting with the Category search function or by directly entering the number.

XA Control	<p>Determines the functioning of the Expanded Articulation (XA) feature of an Element.</p> <p>The XA feature is sophisticated tone generator system that allows you to more effectively recreate realistic sound and natural performance techniques. It also provides other unique modes for random and alternate sound changes as you play.</p> <p>For each Element, you can set to:</p> <ul style="list-style-type: none"> ■ Normal: The Element sounds normally each time you play the note. ■ Legato: When the Mono/Poly parameter is set to Mono, this Element will be played in place of the one which is set to “Normal” of the XA Control parameter when you play the keyboard in legato fashion (playing the next note of a single-note line or melody before releasing the previous note). ■ Key off: The Element will sound each time you release the note. ■ Cycle (for multiple Elements): Each Element sounds alternately according to its numerical order. In other words, playing the first note will sound Element 1, the second note Element 2, and so on. ■ Random (for multiple Elements): Each Element will sound randomly each time you play the note. ■ A.SW1 On (Assignable Switch 1 On): When the [ASSIGN 1] button is turned On, the Element will sound. ■ A.SW2 On (Assignable Switch 2 On): When the [ASSIGN 2] button is turned On, the Element will sound. ■ A.SW Off (Assignable Switch Off): When both the [ASSIGN 1] and [ASSIGN 2] buttons are turned Off, the Element will sound. <p>To create the desired sound, assign the same Element Group to all Elements that have the same XA features. See “Element Group Number”.</p>
Element Group Number	<p>Determines the group for XA Control.</p> <p>The Elements of a group can be called up in sequential order or in random order. All Elements that have the same type of XA features must have the same group number.</p> <p>This setting does not apply when the XA Control parameters of all Elements are set to “Normal”.</p>
Element Connection Switch	<p>Determines which Insertion Effect (A or B) is used to process each individual Element. Set this to “Thru” to bypass the Insertion Effects for the specified element.</p>
Key Assign Mode	<p>Enables or disables double playback of the same note.</p> <ul style="list-style-type: none"> ■ Single: Double or repeated playback of the same note is not possible. The first note will be stopped, then the next note will be sounded. ■ Multi: All notes are sounded simultaneously. This allows playback of the same note when it is played multiple times in succession (especially for tambourine and cymbal sounds that you would want to ring out to their full decay). <p>In general, you can use the setting Multi. Keep in mind that the Multi setting consumes overall polyphony and that sounds may be cut off.</p>

Part Parameters

Receive Note Off (for Drum Parts)	Determines whether a Drum Key responds to the MIDI Note Off message or not. <ul style="list-style-type: none">■ On: Stops the sound when you release the key (Drum Key). For sustained, non-fading drum sounds.■ Off: Continues the (fading) sound when you release the key (Drum Key).
Alternate Group (for Drum Parts)	Prevents playback of unnatural combinations of Drum Keys. You should assign Drum Keys that cannot be played simultaneously on a real Drum Kit (like open and closed hi-hats) to the same Alternate Group. Select Off for Drum Keys that can be played simultaneously.
Oscillator Key On Reset	Determines whether or not the Oscillator is reset each time a note is played. <ul style="list-style-type: none">■ Off: The Oscillator cycles freely with no key synchronization. Pressing a key starts the Oscillator wave at whatever phase the Oscillator happens to be at that moment.
Spectral Form	Determines a basic waveform of the Operator. <ul style="list-style-type: none">■ Sine: Simple Sine waves without harmonics■ All 1: Waves containing a wide range of harmonics■ All 2: Waves containing a narrow range of harmonics■ Odd 1: Waves containing a wide range of odd-order harmonics■ Odd 2: Waves containing a narrow range of odd-order harmonics■ Res 1: Waves containing a wide range of harmonic peaks■ Res 2: Waves containing a narrow range of harmonic peaks
Spectral Skirt	This parameter is effective for waveforms selected as “Spectral Form,” with the exception of the Sine waveform. It sets the spread of the “skirt” at the bottom of the harmonics curve. Higher values produce a wider skirt and smaller values produce a narrower skirt.
Spectral Resonance	This parameter is effective when “Res 1” or “Res 2” is selected as “Spectral Form.” The center frequency moves to higher frequencies and complex sounds with resonance can be created.
Oscillator Frequency Mode	Determines the Oscillator pitch. <ul style="list-style-type: none">■ Ratio: Sets the Oscillator pitch to correspond to the standard keyboard pitch.■ Fixed: Determines a fixed Oscillator pitch by using Coarse and Fine.

1-2-2 Pitch

The processing unit controls the pitch of the wave output from the Oscillator on the tone generator block of the Electronic Musical Instrument.

You can detune separate Elements/Operators, apply Pitch Scaling and so on. Also, by setting the Pitch Envelope Generator (Pitch EG), you can control how the pitch changes over time.

Coarse Tune	Determines the pitch of each Element/Operator/Drum Key.
Fine Tune	Fine-tunes the pitch of each Element/Operator/Drum Key.
Pitch Velocity Sensitivity	<p>Determines how the pitch of the Element/Operator/Drum Key responds to Velocity.</p> <ul style="list-style-type: none"> ■ Positive values: The harder you play the keyboard, the more the pitch rises. ■ Negative values: The harder you play the keyboard, the more the pitch falls. ■ 0: No change in pitch. <p>This parameter for the Normal Part (FM-X) is available only when "Oscillator Freq Mode" is set to "Fixed."</p>
Pitch Fine Key Follow Sensitivity	<p>Determines the degree to which the notes (specifically, their position or Octave Range) affect the pitch in Fine Tuning.</p> <ul style="list-style-type: none"> ■ Positive values: The pitch of lower notes drops and that of higher notes rises. ■ Negative values: The pitch of lower notes rises and that of higher notes drops.
Random Pitch Depth	<p>This lets you randomly vary the pitch of the Element/Operator for each note you play.</p> <ul style="list-style-type: none"> ■ The higher the value, the greater the pitch variation. ■ 0: No pitch change.
Pitch Key Follow Sensitivity	<p>Determines the sensitivity of the Key Follow effect (the pitch interval of adjacent notes), assuming the pitch of the Center Key as standard.</p> <ul style="list-style-type: none"> ■ +100% (the normal setting): Adjacent notes are pitched one semitone apart. ■ 0%: All notes have the same pitch as the Center Key. ■ Negative values: The settings are reversed. <p>This parameter is useful for creating alternate tunings, or for use with sounds that do not need to be spaced in semitones, such as pitched drum sounds in a Normal Part.</p> <p>In case of the Normal Part (FM-X), available setting value range for the parameter is between 0 and 99. If set to 0, the pitch of the note is same as the pitch of the next note on the keyboard. If set to 99, this results the normal pitch setting (+100%).</p> <p>This parameter is available only when "Oscillator Freq Mode" is set to "Fixed."</p>

Pitch Key Follow Sensitivity Center Key Determines the central note or pitch for Pitch Key Follow Sensitivity. The note number set here is the same pitch as normal regardless of the Pitch Key Follow Sensitivity setting.

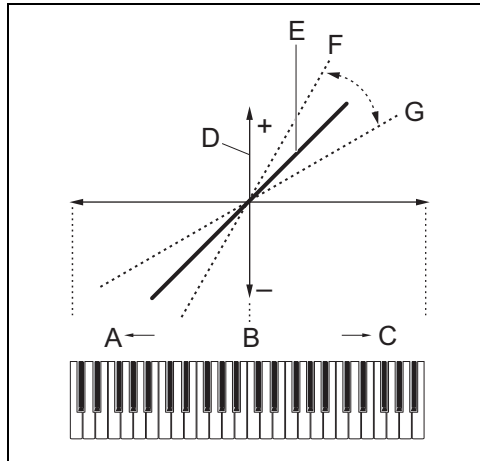

Figure 3: Pitch Key Follow Sensitivity and Center Key

- A: Lower range
- B: Center Key
- C: Higher range
- D: Amount of pitch change
- E: When Pitch Key Follow Sensitivity = +100%
- F: Large
- G: Small

This parameter for the Normal Part (FM-X) is fixed to C3. You can not change the value. This parameter is available only when "Oscillator Freq Mode" is set to "Fixed."

Detune (for Normal Parts (FM-X)) Sets the Output Pitch of the Operator slightly higher or lower. Even if the same parameter value is set for both "Coarse Tune" and "Fine Tune," the Detune lets you slightly raise or lower the pitch of each Operator, allowing you to add an extra dimension to the sound and enhance the spatial characteristics.

1-2-3 Pitch EG (Pitch Envelope Generator)

This lets you control the transition in pitch from the moment the sound starts to the moment the sound stops. You can create the Pitch EG by setting parameters as illustrated below. When you press a key on the keyboard, the pitch of the Part will change according to these Pitch EG settings.

This is useful for creating automatic changes in pitch, which is effective for Synth Brass sounds.

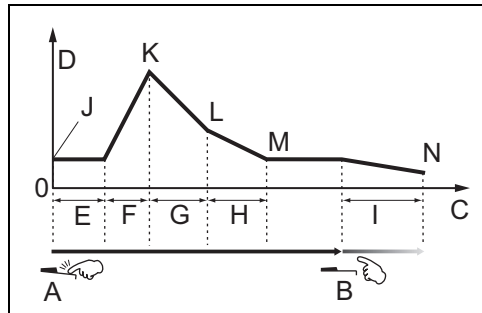

Figure 4: Pitch Envelope Generator (For the Normal Part (AWM2))

- A:** Key On: Pressing the key
- B:** Key Off: Releasing the key
- C:** Time
- D:** Pitch
- E:** Hold Time
- F:** Attack Time
- G:** Decay 1 Time
- H:** Decay 2 Time
- I:** Release Time
- J:** Hold Level
- K:** Attack Level
- L:** Decay 1 Level
- M:** Decay 2 Level = Sustain Level
- N:** Release Level

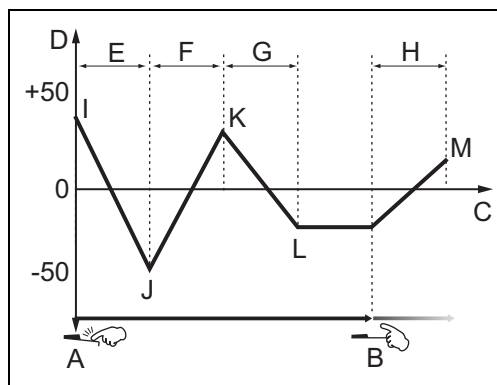

Figure 5: Pitch Envelope Generator (For the Normal Part (FM-X))

- A:** Key On: Pressing the key
- B:** Key Off: Releasing the key
- C:** Time

Part Parameters

D: Pitch
E: Attack Time
F: Decay 1 Time
G: Decay 2 Time
H: Release Time
I: Initial Level
J: Attack Level
K: Decay 1 Level
L: Decay 2 Level
M: Release Level

PEG Hold Time	Determines the time between the moment you press a key on the keyboard and the moment the envelope starts to rise.
PEG Attack Time	Determines the speed of attack from the initial pitch (Hold Level) to the normal pitch of the Part after the Hold Time has elapsed.
PEG Decay 1 Time	Determines how fast the envelope falls from the normal pitch (Attack Level) of the Part to the pitch specified as the Decay 1 Level.
PEG Decay 2 Time	Determines how fast the envelope falls from the pitch specified as the Decay 1 Level to the pitch specified as the Decay 2 Level.
PEG Release Time	Determines how fast the envelope falls from the pitch specified as the Decay 2 Level to the pitch specified as the Release Level when the note is released.
PEG Hold Level	Determines the initial pitch at the moment the key is pressed.
PEG Attack Level	Determines the normal pitch of the pressed key.
PEG Decay 1 Level	Determines the level which the pitch of sound reaches from the Attack Level after the Decay 1 time elapses.
PEG Decay 2 Level	Determines the sustain-level pitch which will be maintained while a note is held.
PEG Release Level	Determines the final pitch reached after the note is released.
PEG Initial Level	Determines the initial pitch at the moment the key is pressed.
PEG Depth	<p>Determines the range over which the pitch envelope changes.</p> <p>For Normal Parts (AWM2)</p> <ul style="list-style-type: none">■ 0: The pitch does not change.■ The farther from 0 the value is, the larger the pitch range.■ Negative values: The pitch change is reversed. <p>For Normal Parts (FM-X)</p> <p>The parameter settings are 8oct, 2oct, 1oct, or 1/2oct. If 8oct is selected and the PEG is set to the minimum value, the input sound pitch (0) moves -4 octaves. If the PEG is set to the maximum value, the input sound pitch moves +4 octaves.</p>

PEG Depth Velocity Sensitivity

Determines how the pitch range of the Element responds to Velocity.

- Positive values: High Velocities cause the pitch range to expand (Figure 6) and low Velocities cause it to contract (Figure 7).
- Negative values (only for Normal Parts (AWM2)): High Velocities cause the pitch range to contract and low Velocities cause it to expand.
- 0: The pitch envelope does not change, regardless of the Velocity.

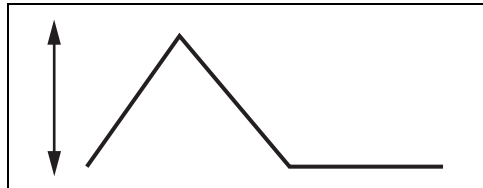

Figure 6: High Velocity, large range

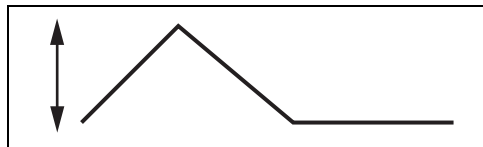

Figure 7: Low Velocity, narrow range

PEG Depth Velocity Sensitivity Curve (only for Normal Parts (AWM2))

Determines how the pitch range will be generated according to the Velocity (strength) with which you play notes on the keyboard. The selected curve is displayed on the screen.

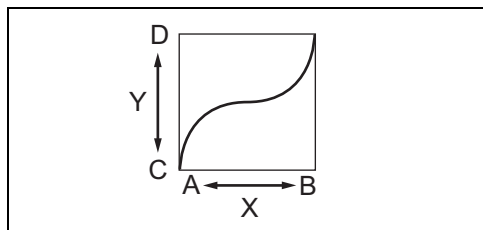

Figure 8: Pitch EG Depth Velocity Sensitivity Curve

- A: Low
- B: High
- C: Narrow
- D: Wide
- X: Velocity
- Y: Pitch Change

PEG Time Velocity Sensitivity (only for Normal Parts (AWM2))

Determines how the PEG transition time (speed) responds to Velocity, or to the strength with which the key is pressed.

- Positive values: High Velocities result in a fast PEG transition speed (Figure 9) while low Velocities result in a slow speed (Figure 10).
- Negative values: High Velocities result in a slow PEG transition speed while low Velocities result in a fast speed.
- **0**: The PEG transition speed does not change, regardless of the Velocity.

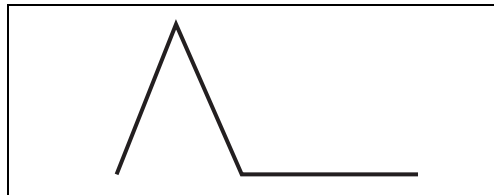

Figure 9: High Velocity, fast speed

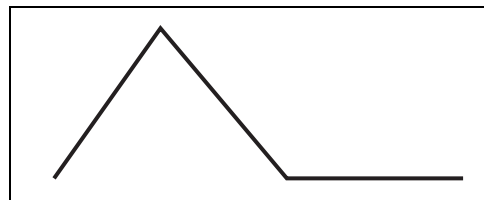

Figure 10: Low Velocity, slow speed

PEG Time Velocity Sensitivity Segment (only for Normal Parts (AWM2))

Determines the part of the PEG that is affected by the PEG Time Velocity Sensitivity.

PEG Time Key Follow Sensitivity

Determines the degree to which the notes (specifically, their position or Octave Range) affect the PEG.

- Positive values: High notes result in a high PEG transition speed while low notes result in a slow speed.
- Negative values (only for Normal Parts (AWM2)): High notes result in a slow PEG transition speed while low notes result in a high speed.
- **0**: The PEG transition speed does not change, regardless of the played note.

PEG Time Key Follow Sensitivity Center Key (only for Normal Parts (AWM2))

Determines the central note or pitch for the PEG Time Key Follow Sensitivity.
When the Center Key note is played, the PEG behaves according to its actual settings.

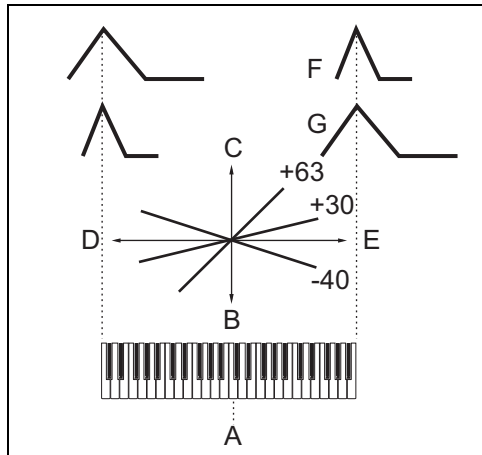

Figure 11: PEG Time Key Follow Sensitivity and Center Key

- A: Center Key
- B: Slower Speed
- C: Faster Speed
- D: Lower range
- E: Higher range
- F: Positive value
- G: Negative value

1-2-4 Filter Type

LPF (Low-Pass Filter)

This is a Filter Type that only passes signals below the Cutoff Frequency. The sound can be brightened by raising the Cutoff Frequency of the filter. On the other hand, the sound can be darkened (muffled) by lowering the Cutoff Frequency of the filter. You can produce a distinctive “peaky” sound by raising the Resonance to boost the signal level in the area of the Cutoff Frequency.

This Filter Type is very popular and useful for producing classic synthesizer sounds.

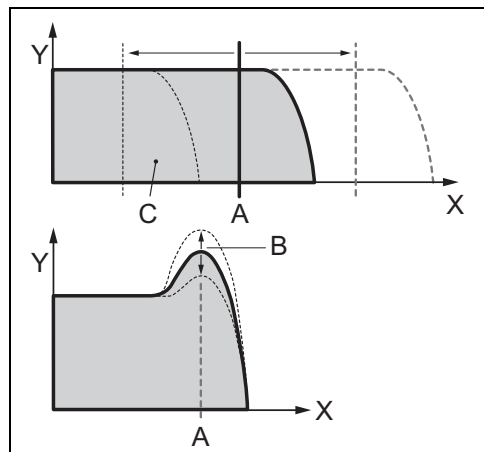

Figure 12: Low-Pass Filter

- A: Cutoff Frequency
- B: Resonance
- C: Frequencies that are “passed” by the filter
- X: Frequency (Pitch)
- Y: Level

LPF24D

A dynamic -24 dB/oct Low-Pass Filter with a characteristic digital sound. Compared to the LPF24A type, this filter can produce a more pronounced Resonance effect.

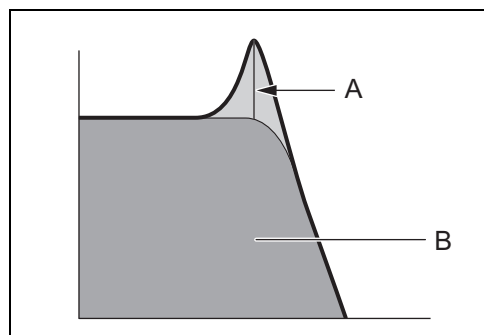

Figure 13: LPF24D

- A: Resonance
- B: Frequencies that are “passed” by the filter

LPF24A	A digital dynamic Low-Pass Filter with characteristics similar to a 4-pole analog synthesizer filter.
LPF18	3-pole -18 dB/oct Low-Pass Filter.
LPF18s	3-pole -18 dB/oct Low-Pass Filter. This filter has a smoother cutoff slope than the LPF18 type.
HPF (High-Pass Filter)	A Filter Type that only passes signals above the Cutoff Frequency. You can use the Resonance parameter to add further character to the sound.

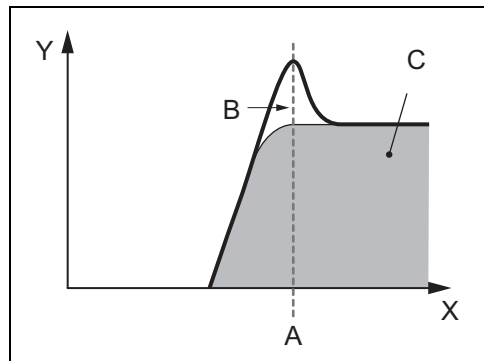

Figure 14: High-Pass Filter

- A:** Cutoff Frequency
- B:** Resonance
- C:** Frequencies that are “passed” by the filter
- X:** Frequency (Pitch)
- Y:** Level

HPF24D	A dynamic -24 dB/oct High-Pass Filter with a characteristic digital sound. This filter can produce a pronounced Resonance effect.
---------------	--

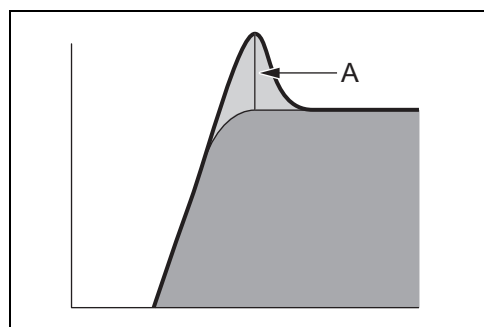

Figure 15: HPF24D

- A:** Resonance

HPF12	-12 dB/oct dynamic High-Pass Filter.
--------------	--------------------------------------

BPF (Band-Pass Filter) A Filter Type that only passes a band of signals around the Cutoff Frequency.

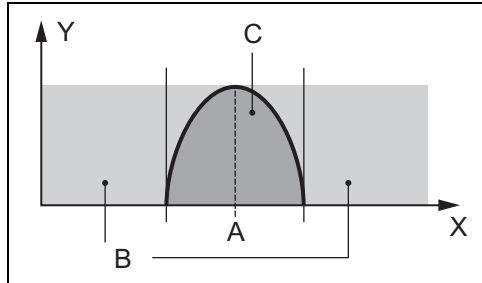

Figure 16: Band-Pass Filter

- A:** Center Frequency
- B:** Cutoff Range
- C:** Frequencies that are “passed” by the filter
- X:** Frequency
- Y:** Level

BPF12D The combination of a -12 dB/oct HPF and LPF with a characteristic digital sound.

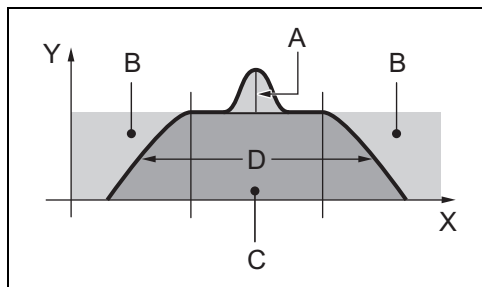

Figure 17: BPF12D

- A:** Resonance
- B:** Cutoff Range
- C:** Frequencies that are “passed” by the filter
- D:** -12 dB/oct
- X:** Frequency
- Y:** Level

BPF6

The combination of a -6 dB/oct HPF and LPF.

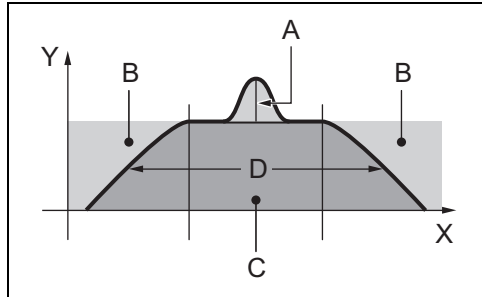

Figure 18: BPF6

- A: Resonance
- B: Cutoff Range
- C: Frequencies that are “passed” by the filter
- D: -6 dB/oct
- X: Frequency
- Y: Level

BPFw

A -12 dB/oct BPF that combines HPF and LPF filters to allow wider bandwidth settings.

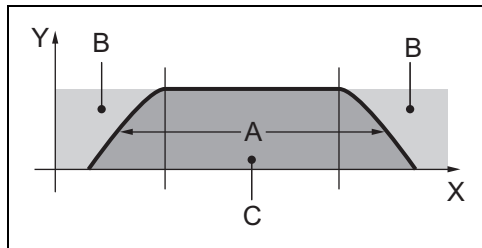

Figure 19: BPFw

- A: Width can be increased
- B: Cutoff Range
- C: Frequencies that are “passed” by the filter
- X: Frequency
- Y: Level

BEF (Band-Eliminate Filter)

The Band-Eliminate Filter has an opposite effect on the sound compared to the Band-Pass Filter. When this Filter Type is selected, you can set the Cutoff Frequency around which the audio signal is muted or eliminated.

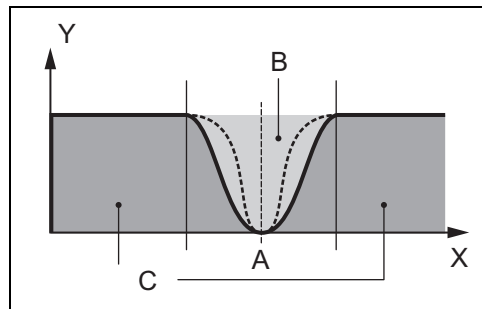

Figure 20: Band-Eliminate Filter

- A: Center Frequency
- B: Cutoff Range
- C: Frequencies that are "passed" by the filter
- X: Frequency
- Y: Level

BEF12	-12 dB/oct Band-Eliminate Filter.
BEF6	-6 dB/oct Band-Eliminate Filter.
Dual LPF	Two -12 dB/oct Low-Pass Filters connected in parallel. You can edit the distance between the two Cutoff Frequencies. The result of the filter is displayed on the screen.

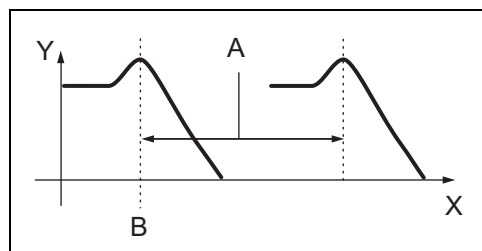

Figure 21: Dual Low-Pass Filters

- A: Distance
- B: Lower Cutoff Frequency (Once you set the Lower Cutoff Frequency, the Higher Cutoff Frequency will be automatically set.)
- X: Frequency
- Y: Level

Dual HPF	Two -12 dB/oct High-Pass Filters connected in parallel.
Dual BPF	Two -6 dB/oct Band-Pass Filters connected in parallel.

Dual BEF

Two -6 dB/oct Band-Eliminate Filters connected in serial.

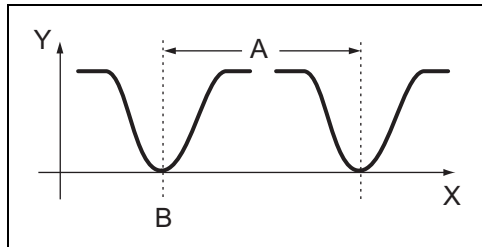

Figure 22: Dual Band-Eliminate Filters

- A:** Distance
- B:** Lower Cutoff Frequency (Once you set the Lower Cutoff Frequency, the Higher Cutoff Frequency will be automatically set.)
- X:** Frequency
- Y:** Level

LPF12+HPF12

A combination of a -12 dB/oct Low-Pass Filter and a -12 dB/oct High-Pass Filter connected in serial.
When this Filter Type is selected, HPF Cutoff and HPF Key Follow Sensitivity can be set.

LPF6+HPF6

A combination of a -6 dB/oct Low-Pass Filter and a -6 dB/oct High-Pass Filter connected in serial.
When this Filter Type is selected, HPF Cutoff and HPF Key Follow Sensitivity can be set.

LPF12+BPF6

A combination of a -12 dB/oct Low-Pass Filter and a -6 dB/oct Band-Pass Filter connected in parallel.
You can edit the distance between the two Cutoff Frequencies. The result of the filter is displayed on the screen.

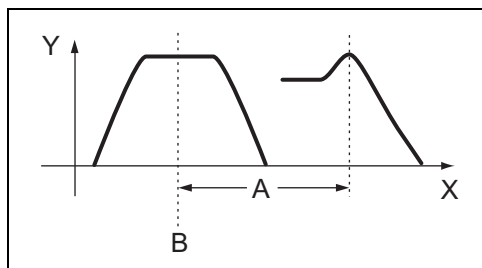

Figure 23: LPF12+BPF6

- A:** Distance
- B:** Lower Cutoff Frequency (Once you set the Lower Cutoff Frequency, the Higher Cutoff Frequency will be automatically set.)
- X:** Frequency
- Y:** Level

1-2-5 Filter

A filter is a circuit or processor that modifies tone by blocking or passing a specific frequency range of the sound.

Filters work by allowing portions of the signal lower or higher than a specified frequency to pass, and cutting the remainder of the signal. This specified frequency is referred to as the Cutoff Frequency. You can produce a relatively brighter or darker sound depending on how you set the Cutoff Frequency.

By adjusting the Resonance (which boosts the level of the signal in the area of the Cutoff Frequency), you can produce a distinctive “peaky” tone, making the sound brighter and harder. On the tone generator block of the Electronic Musical Instrument, the sound signal output from the Pitch unit is processed by the Filter unit.

Cutoff Frequency	Determines the Cutoff Frequency for the Filter, or the central frequency around which the Filter is applied. The tonal characteristics of the Sound and function of the Cutoff Frequency differ depending on which Filter Type is selected.
Cutoff Velocity Sensitivity	Determines how the Cutoff Frequency responds to Velocity, or the strength with which you play notes. <ul style="list-style-type: none"> ■ Positive values: The more strongly you play the keyboard, the more the Cutoff Frequency rises. ■ Negative values: The more softly you play the keyboard, the more the Cutoff Frequency rises. ■ 0: The Cutoff Frequency does not change, regardless of the Velocity.
Distance	Determines the Distance between the two Cutoff Frequencies of the Dual Filter Types (which consist of two identical filters in parallel), and of the LPF12+BPF6 type. When any other Filter Type is selected, this parameter is not available.
Resonance	Resonance is used to set the amount of Resonance (harmonic emphasis) applied to the signal at the Cutoff Frequency. This parameter can boost the level of the signal in the area of the Cutoff Frequency. By emphasizing the overtones in this area, this can produce a distinctive “peaky” tone, making the sound brighter and harder. This can be used in combination with the Cutoff Frequency parameter to add further character to the sound. This parameter is available when an LPF, HPF, BPF (excluding the BPFw), or BEF is selected as a Filter Type.
Width	The Width parameter is used to adjust the width of the band of signal frequencies passed by the filter with the BPFw. This parameter is available when a BPFw is selected as a Filter Type.
Resonance Velocity Sensitivity	Determines the degree to which Resonance responds to Velocity, or the strength with which you play notes. <ul style="list-style-type: none"> ■ Positive values: The higher the Velocity, the greater the Resonance. ■ Negative values: The lower the Velocity, the greater the Resonance. ■ 0: No change of the Resonance value. <p>This parameter is available when an LPF, HPF, BPF, or BEF is selected as a Filter Type.</p>
Gain	Determines the Gain of the signal sent to the filter. The lower the value, the lower the Gain of the Element.

Cutoff Key Follow Sensitivity	<p>Determines the degree to which the notes (specifically, their position or Octave Range) affect the Cutoff Frequency of the Filter.</p> <ul style="list-style-type: none"> ■ Positive values: The Cutoff Frequency drops for lower notes and rises for higher notes. ■ Negative values: The Cutoff Frequency rises for lower notes and drops for higher notes.
Cutoff Key Follow Sensitivity Center Key	<p>This indicates that the central note for Cutoff Key Follow Sensitivity is C3. The setting value is fixed. You can not change it.</p>

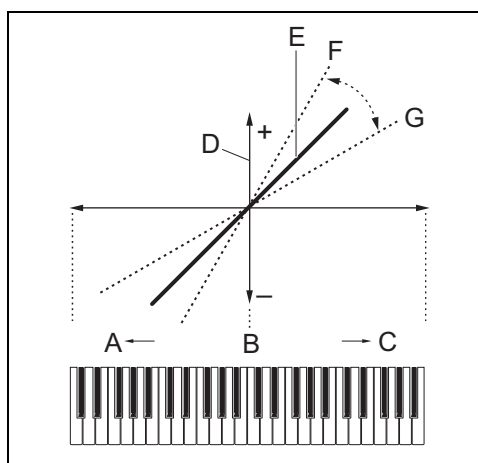

Figure 24: Cutoff Key Follow Sensitivity and Center Key

- A: Lower range
- B: Center Key = C3
- C: Higher range
- D: Amount of Cutoff Frequency change
- E: When Cutoff Key Follow Sensitivity = 100
- F: Large
- G: Small

HPF Cutoff Frequency	<p>Determines the Cutoff Frequency of the High-Pass Filter. This parameter is only available for Filter Types LPF12+HPF12 and LPF6+HPF6.</p>
HPF Cutoff Key Follow Sensitivity	<p>Determines the degree to which the notes (specifically, their position or Octave Range) affect the Cutoff Frequency of the HPF.</p> <ul style="list-style-type: none"> ■ Positive values: The Cutoff Frequency drops for lower notes and rises for higher notes. ■ Negative values: The Cutoff Frequency rises for lower notes and drops for higher notes. <p>This parameter is only available for Filter Types LPF12+HPF12 and LPF6+HPF6.</p>
HPF Cutoff Key Follow Sensitivity Center Key	<p>This indicates that the central note for HPF Cutoff Key Follow Sensitivity is C3. The setting value is fixed. You can not change it.</p>

1-2-6 Filter EG (Filter Envelope Generator)

This lets you control the transition in tone from the moment the sound starts to the moment the sound stops. You can create a custom Filter EG by setting parameters as illustrated below. When you press a key on the keyboard, the Cutoff Frequency will change according to these EG settings.

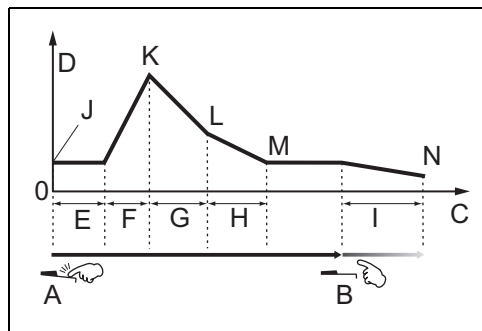

Figure 25: Filter Envelope Generator

- A:** Key On: Pressing the key
- B:** Key Off: Releasing the key
- C:** Time
- D:** Cutoff Frequency
- E:** Hold Time
- F:** Attack Time
- G:** Decay 1 Time
- H:** Decay 2 Time
- I:** Release Time
- J:** Hold Level
- K:** Attack Level
- L:** Decay 1 Level
- M:** Decay 2 Level = Sustain Level
- N:** Release Level

FEG Hold Time	Determines the time between the moment you press a key on the keyboard and the moment the envelope starts to rise.
FEG Attack Time	Determines the speed of attack from the initial Cutoff Frequency (at Hold Level) to the maximum level of the Part after the Hold Time has elapsed.
FEG Decay 1 Time	Determines how fast the envelope falls from the maximum Cutoff Frequency (at Attack Level) to the Cutoff Frequency specified as the Decay 1 Level.
FEG Decay 2 Time	Determines how fast the envelope falls from the Cutoff Frequency specified as the Decay 1 Level to the Cutoff Frequency specified as the Decay 2 Level.
FEG Release Time	Determines how fast the envelope falls from the Cutoff Frequency specified as the Decay 2 Level to the Cutoff Frequency specified as the Release Level when the note is released.
FEG Hold Level	Determines the initial Cutoff Frequency at the moment the key is pressed.
FEG Attack Level	Determines the maximum Cutoff Frequency which the envelope reaches after a key is pressed.

FEG Decay 1 Level	Determines the level which the Cutoff Frequency reaches from the Attack Level after the Decay 1 Time elapses.
FEG Decay 2 Level	Determines the Cutoff Frequency which will be maintained while a note is held.
FEG Release Level	Determines the final Cutoff Frequency reached after the note is released.
FEG Time Key Follow Sensitivity	<p>Determines the degree to which the notes (specifically, their position or Octave Range) affect the Cutoff Frequency of the FEG.</p> <ul style="list-style-type: none"> ■ Positive values: High notes result in a fast FEG transition speed while low notes result in a slow speed. ■ Negative values: High notes result in a slow FEG transition speed while low notes result in a fast speed. ■ 0: The FEG transition speed does not change, regardless of which note is played.
FEG Time Key Follow Sensitivity Center Key	Determines the central note or pitch for FEG Time Key Follow Sensitivity. When the Center Key note is played, the FEG behaves according to its actual settings.

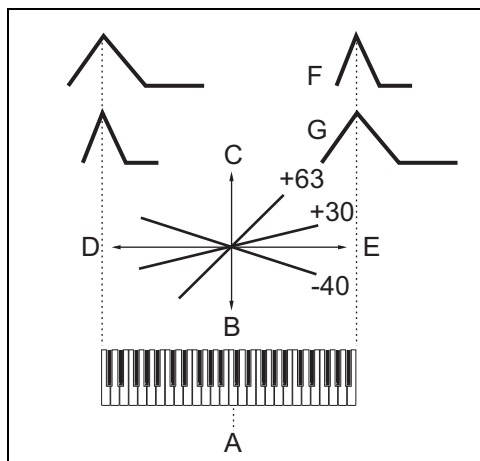

Figure 26: Filter EG Time Key Follow Sensitivity and Center Key

- A: Center Key
- B: Slower Speed
- C: Faster Speed
- D: Lower range
- E: Higher range
- F: Positive value
- G: Negative value

FEG Time Velocity Sensitivity

Determines how the FEG transition time (speed) responds to Velocity, or the strength with which the key is pressed.

- Positive values: High Velocities result in a fast FEG transition speed (Figure 27) while low Velocities result in a slow speed (Figure 28).
- Negative values: High Velocities result in a slow FEG transition speed while low Velocities result in a fast speed.
- 0: The pitch transition speed does not change, regardless of the Velocity.

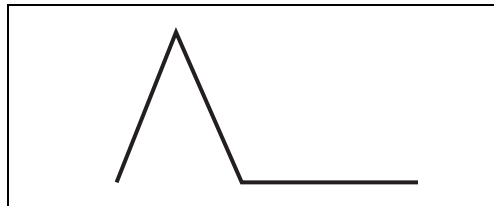

Figure 27: High Velocity, fast speed

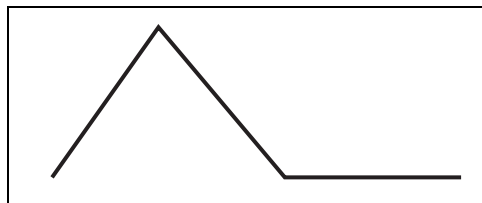

Figure 28: Low Velocity, slow speed

FEG Time Velocity Sensitivity Segment

Determines the part of the FEG that is affected by the FEG Time Velocity Sensitivity.

FEG Depth

Determines the range over which the Cutoff Frequency envelope changes.

- 0: The Cutoff Frequency does not change.
- The farther from 0 the value is, the larger the range of the Cutoff Frequency.
- Negative values: The change of the Cutoff Frequency is reversed.

FEG Depth Velocity Sensitivity

Determines how the range of the Cutoff Frequency responds to Velocity.

- Positive values: High Velocities cause the FEG range to expand (Figure 29) and low Velocities cause it to contract (Figure 30).
- Negative values: High Velocities cause the FEG range to contract and low Velocities cause it to expand.
- 0: The FEG range does not change, regardless of the Velocity.

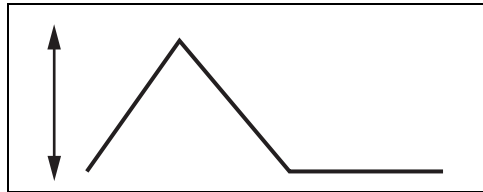

Figure 29: High Velocity, large range

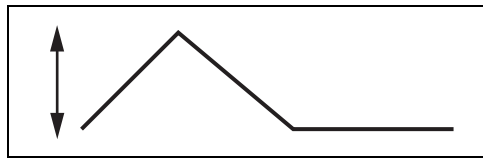

Figure 30: Low Velocity, narrow range

FEG Depth Velocity Sensitivity Curve

This curve determines how the FEG transition range changes according to the Velocity (strength) with which you play notes on the keyboard. Figure 31 shows an example in which the middle range of Velocities causes the FEG transition range not to change and the higher/lower range of Velocities causes it to change more rapidly.

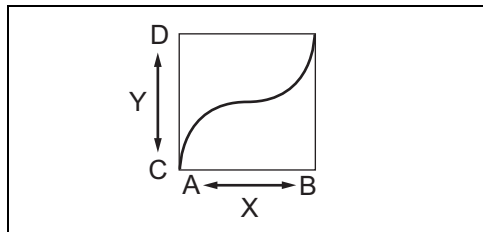

Figure 31: Filter EG Depth Velocity Sensitivity Curve

- A: Low
- B: High
- C: Narrow
- D: Wide
- X: Velocity
- Y: Filter EG Transition Range (Cutoff Frequency range)

1-2-7 Filter Scale

This controls the Filter Cutoff Frequency according to the positions of the notes on the keyboard. You can divide the entire keyboard into different areas by setting four Break Points, and assign different Cutoff Frequency Offset values to these Break Points. The Cutoff Frequency changes in a linear fashion between successive Break Points.

Table 1 and Figure 32 show an example in which the basic Cutoff Frequency value is 64 and the various Offset values of the Break Points change that basic value accordingly.

Table 1: Offsets at Break Points

Break Point	1	2	3	4
Note	C#1	D#2	C3	A4
Offset	-4	+10	+17	+4

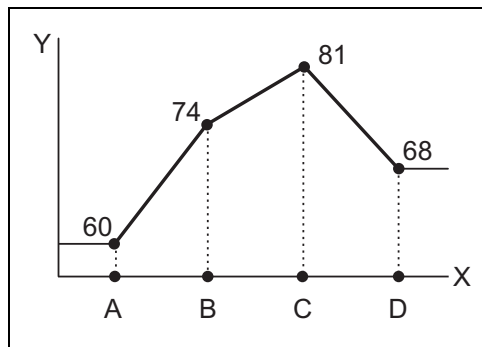

Figure 32: Filter Scale

- A:** Break Point 1
- B:** Break Point 2
- C:** Break Point 3
- D:** Break Point 4
- X:** Note
- Y:** Cutoff Frequency

Break Point 1 - 4	Determines the four Filter Scale Break Points by specifying their respective note numbers.
<hr/>	
Offset 1 - 4	Determines the offset value of the Cutoff Frequency of each Filter Scale Break Point.

1-2-8 Amplitude

The Amplitude unit controls the output level (amplitude or volume) of the Element/Operator/ Drum Key. The signals are sent at this output level to the Effect block (see Chapter 2 Effects). By setting the Amplitude Envelope Generator (AEG), you can control how the Amplitude changes over time.

Level	Determines the output level of the Element/Operator/Drum Key.
Level Velocity Sensitivity	Determines how the output level of the Element/Operator/Drum Key responds to Velocity. <ul style="list-style-type: none"> ■ Positive values: The more strongly you play the keyboard, the more the output rises. ■ Negative values: The more softly you play the keyboard, the more the output rises ■ 0: The output level does not change.
Level Velocity Sensitivity Offset	Raises or lowers the level specified by the Level Velocity Sensitivity. If the result is higher than 127, the velocity is set to 127.

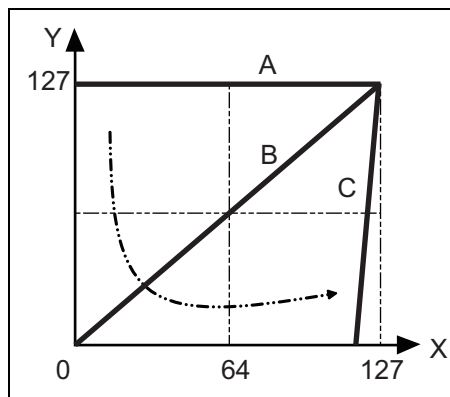

Figure 33: Level Velocity Sensitivity Offset = 0

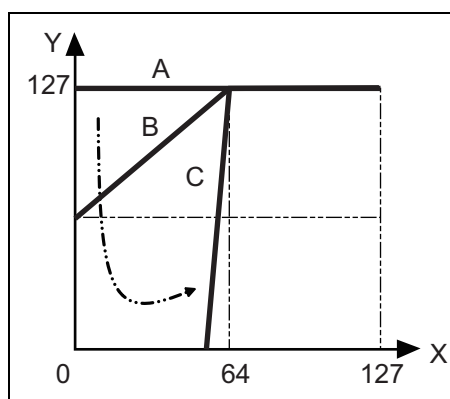

Figure 34: Level Velocity Sensitivity Offset = 64

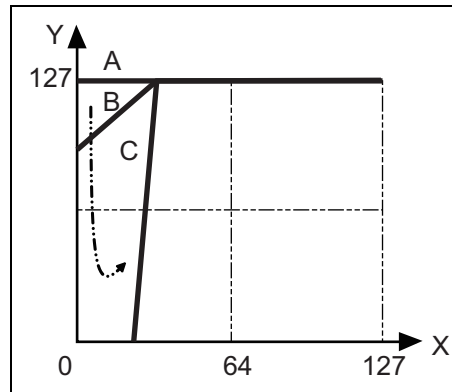

Figure 35: Level Velocity Sensitivity Offset = 96

- A: Level Velocity Sensitivity = 0
- B: Level Velocity Sensitivity = 32
- C: Level Velocity Sensitivity = 64
- X: Velocity with which you play a note
- Y: Actual resulting velocity (affecting the tone generator)

Level Velocity Sensitivity Curve Determines how the actual Velocity will be generated according to the Velocity (strength) with which you play notes on the keyboard. The selected curve is displayed on the screen.

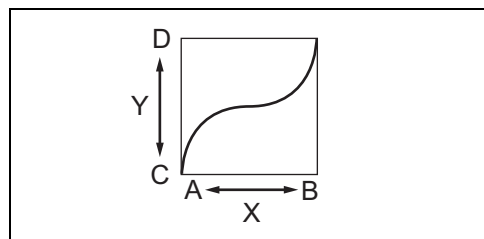

Figure 36: Level Velocity Sensitivity Curve

- A: Soft
- B: Strong
- C: Low
- D: High
- X: Velocity (Playing strength)
- Y: Volume

Element Pan Adjusts the stereo pan position of the sound.
This Element Pan parameter may have little or no audible effect if Pan for a specific element is set to the left position and Pan for another element is set to the right position.

Alternate Pan Determines the amount by which the sound is panned alternately left and right for each key you press.
The Pan setting is used as the Center Pan position.
Higher values increase the width of the Pan range.

Random Pan Determines the amount by which the sound of the selected Element is panned randomly left and right for each key you press.
The Pan setting is used as the Center Pan position.

<p>Scaling Pan</p>	<p>Determines the degree to which the notes (specifically, their position or Octave Range) affect the Pan position, left and right. At note C3, the main Pan setting is used for the basic Pan position.</p> <ul style="list-style-type: none"> ■ Positive values: Moves the pan position to the left for lower notes and to the right for higher notes. ■ Negative values: Moves the pan position to the right for lower notes and to the left for higher notes.
<p>Level Key Follow Sensitivity</p>	<p>Determines the degree to which the notes (specifically, their position or Octave Range) affect the Amplitude level of the selected Element.</p> <ul style="list-style-type: none"> ■ Positive values: Lowers the output level for lower notes and raises it for higher notes. ■ Negative values: Raises the output level for lower notes and lowers it for higher notes.
<p>Level Key Follow Sensitivity Center Key</p>	<p>This indicates that the central note for Level Key Follow Sensitivity is C3. The setting value is fixed. You can not change it.</p>

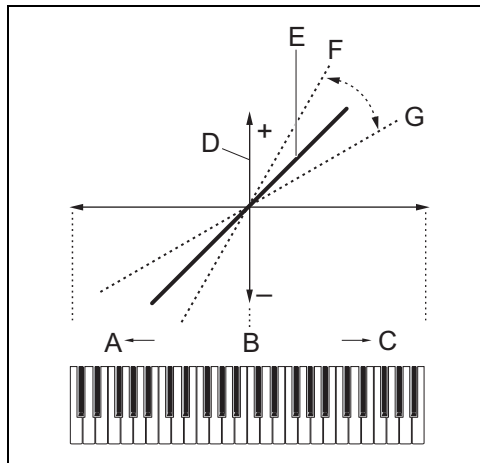

Figure 37: Level Key Follow Sensitivity and Center Key

- A: Lower range
- B: Center Key = C3
- C: Higher range
- D: Amount of Amplitude EG level change
- E: Level Key Follow Sensitivity = +32
- F: Large
- G: Small

1-2-9 Amplitude EG (Amplitude Envelope Generator)

This lets you control the transition in Amplitude from the moment the sound starts until the moment the sound stops. You can create a custom Amplitude EG by setting parameters as illustrated below. When you press a key on the keyboard, the volume will change according to these EG settings.

- For Normal Parts (AWM2) and Drum Parts

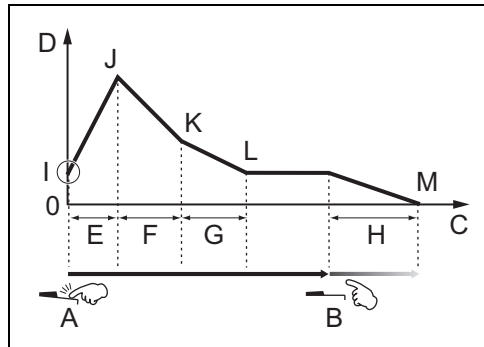

Figure 38: Amplitude Envelope Generator

- A:** Key On: Pressing the key
- B:** Key Off: Releasing the key
- C:** Time
- D:** Level (volume)
- E:** Attack Time
- F:** Decay 1 Time
- G:** Decay 2 Time
- H:** Release Time
- I:** Initial Level
- J:** Attack Level
- K:** Decay 1 Level
- L:** Decay 2 Level = Sustain Level
- M:** Release Level

- For Normal Parts (FM-X)

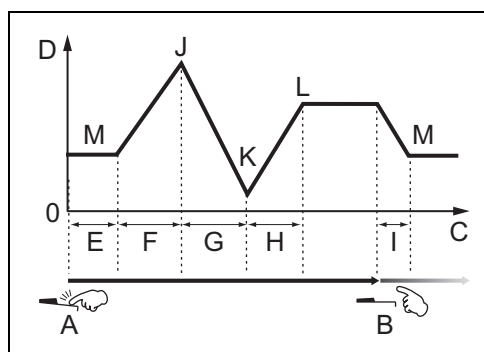

Figure 39: Amplitude Envelope Generator

- A:** Key On: Pressing the key
- B:** Key Off: Releasing the key

Part Parameters

C: Time
D: Level (volume)
E: Hold Time
F: Attack Time
G: Decay 1 Time
H: Decay 2 Time
I: Release Time
J: Attack Level
K: Decay 1 Level
L: Decay 2 Level
M: Release (Hold) Level

AEG Attack Time	Determines how quickly the sound reaches its maximum level after the key is pressed.
AEG Decay 1 Time	Determines how fast the envelope falls from the Attack Level to the Decay 1 Level.
AEG Decay 2 Time	Determines how fast the envelope falls from the Decay 1 Level to the Decay 2 Level (sustain level).
AEG Release Time	Determines how quickly the sound decays to silence after the key is released.
AEG Initial Level	Determines the initial level at the moment the key is pressed.
AEG Attack Level	Determines the maximum level which the envelope reaches after a key is pressed.
AEG Decay 1 Level	Determines the level which the envelope reaches from the Attack Level after the Decay 1 Time elapses.
AEG Decay 2 Level	Determines the level which will be maintained while a note is held.
AEG Release (Hold) Level (For Normal Parts (FM-X))	Determines the final level reached after the note is released.
AEG Hold Time	Determines the time between the moment you press a key on the keyboard and the moment the level reaches the specified hold level.
AEG Time Key Follow Sensitivity	<p>Determines the degree to which the notes (specifically, their position or Octave Range) affect the Amplitude EG times.</p> <ul style="list-style-type: none"> ■ Positive values: High notes result in a fast Amplitude EG transition speed while low notes result in a slow speed. ■ Negative values (for Normal Part (AWM2)): High notes result in a slow Amplitude EG transition speed while low notes result in a fast speed. ■ 0: The Amplitude EG transition speed does not change, regardless of the played note.

AEG Time Key Follow Sensitivity Center Key

Determines the central note for AEG Time Key Follow Sensitivity. When the Center Key note is played, the AEG behaves according to its actual settings.

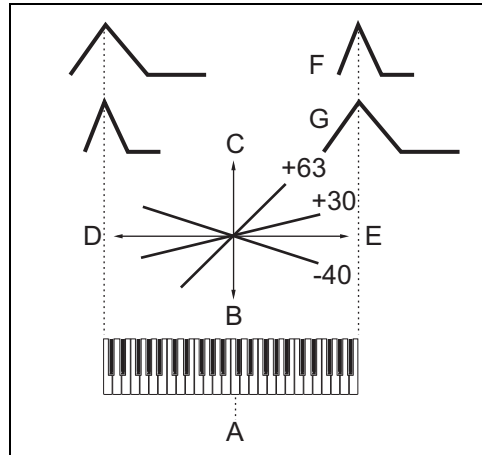

Figure 40: Amplitude EG Time Key Follow Sensitivity and Center Key

- A:** Center Key
- B:** Slower Speed
- C:** Faster Speed
- D:** Lower range
- E:** Higher range
- F:** Positive value
- G:** Negative value

AEG Time Key Follow Sensitivity Release Adjustment

Determines the sensitivity of AEG Time Key Follow Sensitivity to AEG Release.

The lower the value, the lower the sensitivity.

- **127:** Sets the AEG Time Key Follow Sensitivity to the value of Decay 1 or Decay 2.
- **0:** Produces no effect in the AEG Time Key Follow Sensitivity.

AEG Time Velocity Sensitivity

Determines how the AEG transition time (speed) responds to Velocity, or the strength with which the key is pressed.

- Positive values: High Velocities result in a fast AEG transition speed (Figure 41) while low Velocities result in a slow speed (Figure 42).
- Negative values: High Velocities result in a slow AEG transition speed while low Velocities result in a fast speed.
- 0: The amplitude transition speed does not change, regardless of the Velocity.

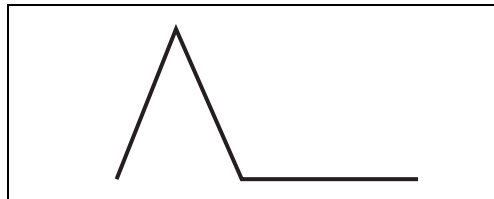

Figure 41: High Velocity, fast speed

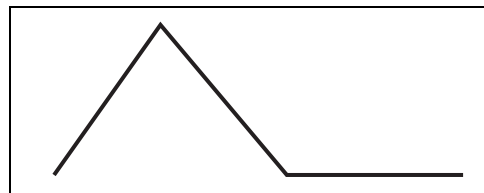

Figure 42: Low Velocity, slow speed

AEG Time Velocity Sensitivity Segment

Determines the part of the Amplitude EG that is affected by AEG Time Velocity Sensitivity.

Half Damper Switch

Determines if the Half Damper is switched on. When the Half Damper Switch is set to On, holding down the FC3 Foot Controller produces a “half-pedal” effect just as on a real acoustic piano.

Half Damper Time

Determines how quickly the sound decays to silence after the key is released while holding down the Foot Controller FC3 with the Half Damper Switch set to On.

After releasing the key, you can control the decay time of the sound via the Foot Controller position, with the Half Damper Time of the AEG being the maximum decay value and the Release Time of the AEG being the minimum decay value.

When you release the pedal, the decay time after the key is released is equivalent to the AEG Release Time. You can create a piano-like effect by setting the Release Time to a small value and setting the Half Damper Time to a large value.

1-2-10 Amplitude Scale

This controls the Amplitude output level according to the positions of the notes on the keyboard.

- For Normal Parts (AWM2) and Drum Parts

You can divide the entire keyboard into different areas by setting four Break Points, and assign different Amplitude Offset values to these Break Points.

The Amplitude changes in a linear fashion between successive Break Points.

Table 2 and Figure 43 show an example in which the basic Amplitude (volume) value for the selected Element is 80 and the various Offset values of the Break Points change that basic value accordingly.

Table 2: Offsets at Break Points

Break Point	1	2	3	4
Note	C1	C2	C3	C4
Offset	-4	+10	+17	+4

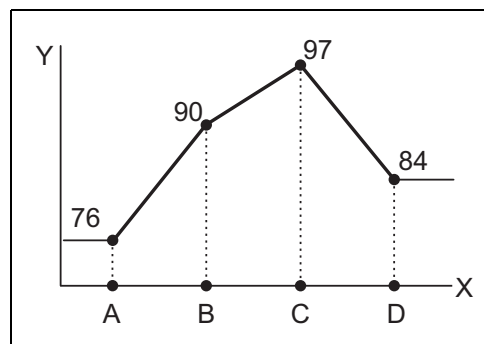

Figure 43: Amplitude Scale

- A:** Break Point 1
- B:** Break Point 2
- C:** Break Point 3
- D:** Break Point 4
- X:** Note
- Y:** Amplitude

Break Point 1 - 4 Determines the four Amplitude Scale Break Points by specifying their respective note numbers.

Offset 1 - 4 Determines the offset value of the level of each Amplitude Scale Break Point.

■ For Normal Parts (FM-X)

The keyboard is divided into two sections at the break point.
 The high-pitch side at the right is set by using the R Depth and the R Curve; the low-pitch side at the left is set by using the L Depth and the L Curve as described below.

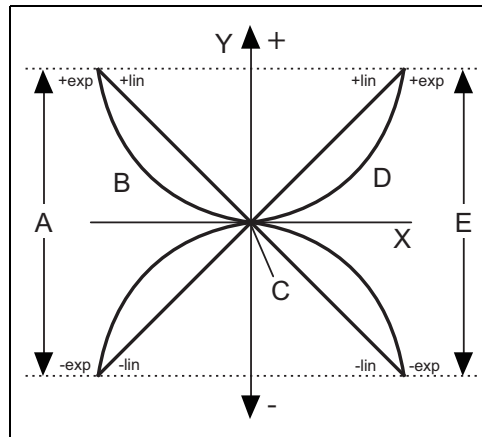

Figure 44: Amplitude Scale

- A:** Low Depth
- B:** Low Curve
- C:** BP Output Level
- D:** High Curve
- E:** High Depth
- X:** Key
- Y:** Level

The Output Level of the Key set as the Level Scaling Break Point depends on the Operator Level setting. For the Keys in the left side of the Level Scaling Break Point, the Output Level is adjusted based on the curve determined by the Low Curve and Low Depth. For the Keys in the right side of the Level Scaling Break Point, the Output Level is adjusted based on the curve determined by the High Curve and High Depth. The Output Level changes in an exponential fashion from the Break Point on the Exp type curve and the Output Level changes in a linear fashion from the Break Point in the Linear type curve. In either case, the farther away from the Break Point the key is, the greater the Output Level changes for the key.

Break Point	Determines the Break Point by specifying the respective note number.
Low/High Curve	Determines the curve for level change.
Low/High Depth	Determines the curve degree.

1-2-11 LFO (Low-Frequency Oscillator)

The Low-Frequency Oscillator (LFO) unit of the tone generator block generates a low-frequency signal.

The signal from the LFO can be used to modulate the pitch, filter, and amplitude. Modulating the pitch produces a vibrato effect, modulating the filter produces a wah effect, and modulating the amplitude produces a tremolo effect.

You can set the Common LFO, which determines the basic LFO parameters that are common to all Elements/Operators of the Part. Also, you can set the Element LFO, which determines the LFO parameters for each individual Element/Operator.

LFO Wave	Selects the Wave and determines how the LFO waveform modulates the sound.
Speed	Determines the speed of the LFO Wave. The higher the value, the faster the speed.
Key On Reset	Determines whether or not the LFO is reset each time a note is played. <ul style="list-style-type: none"> ■ Off: The LFO cycles freely with no key synchronization. Pressing a key starts the LFO wave at whatever phase the LFO happens to be at that moment.

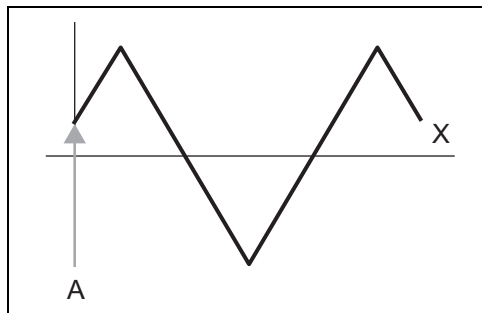

Figure 45: Key On Reset Off

A: Key On
X: Time

- **Each-on:** The LFO resets with each note you play and starts a waveform at the phase specified by the Phase parameter.

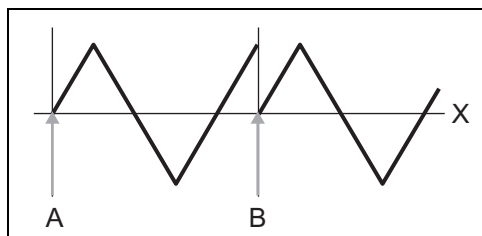

Figure 46: Key On Reset Each-on

A: Key On (first note)
B: Key On (second note)
X: Time

- **1st-on:** The LFO resets with each note you play and starts a waveform at the phase specified by the Phase parameter. If you play a second note while the first is being held, the LFO continues cycling according to the same phase as triggered by the first note--in other words, the LFO only resets if the first note is released before the second is played.

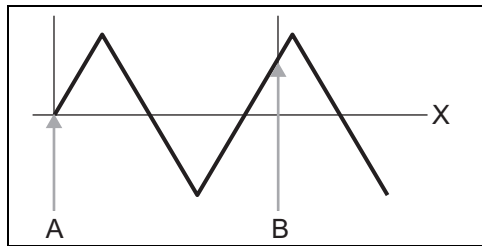

Figure 47: Key On Reset 1st-on

- A:** Key On (first note)
- B:** Key On (second note)
- X:** Time

Delay	Determines the delay time between the moment you press a key on the keyboard and the moment the LFO comes into effect. A higher value results in a longer delay time.
--------------	--

Fade-In Time Determines the amount of time for the LFO effect to fade in after the Delay time has elapsed.

- A higher value results in a slower fade-in.
- **0**: The LFO effect will not fade in but reach the maximum level immediately after the Delay time has elapsed.

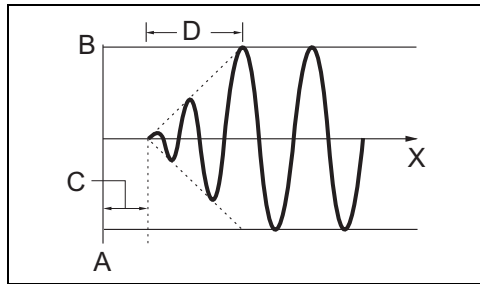

Figure 48: Lower value: faster fade-in

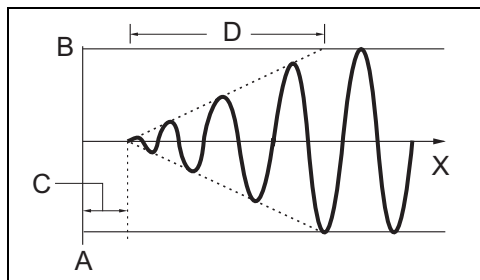

Figure 49: Higher value: slower fade-in

- A: Key On
- B: Maximum
- C: Delay
- D: Fade-In
- X: Time

Pitch Modulation Depth Determines the amount (depth) by which the LFO Wave varies (modulates) the pitch of the sound.
The higher the setting, the greater the depth of control.

Filter Modulation Depth Determines the amount (depth) by which the LFO Wave varies (modulates) the Filter Cutoff Frequency.
The higher the setting, the greater the depth of control.

Amplitude Modulation Depth Determines the amount (depth) by which the LFO Wave varies (modulates) the Amplitude of the sound.
The higher the setting, the greater the depth of control.

Tempo Sync Determines whether or not the LFO speed is synchronized to the tempo of the phrase.

Random Speed Determines the degree to which the LFO speed changes at random.

- Higher values result in a larger degree of speed change.
- **0**: Results in the original speed.

This parameter cannot be set when Tempo Sync is set to **On**.

Tempo Speed This parameter allows you to make detailed note value settings that determine how the LFO pulses in sync with the phrase. This parameter is only available when the Tempo Sync parameter has been set to On.

Hold (Hold/Hold Time) Determines the time during which the LFO is held at its maximum level.

- A higher value results in a longer Hold Time.
- **Hold:** No fade-out.

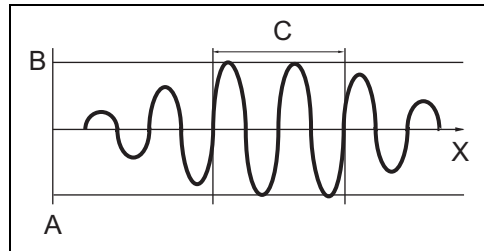

Figure 50: Hold Time

- A: Key On
- B: Maximum
- C: Hold
- X: Time

Fade-Out Time Determines the amount of time for the LFO effect to fade out (after the Hold Time has elapsed).
A higher value results in a slower fade-out.

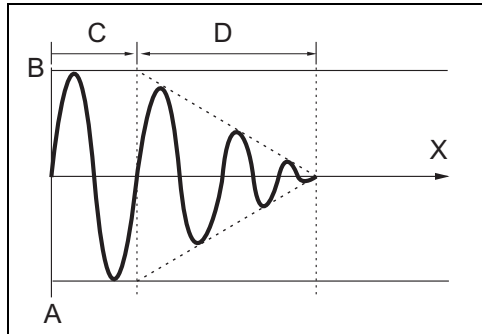

Figure 51: Lower value: faster fade-out

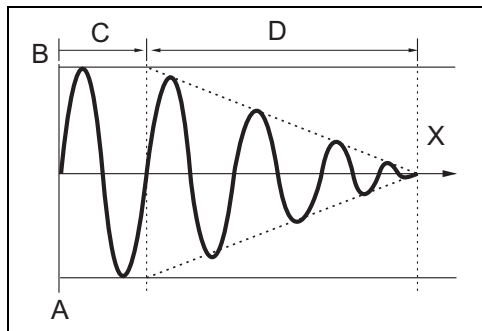

Figure 52: Higher value: slower fade-out

- A: Key On
- B: Maximum
- C: Hold
- D: Fade-Out
- X: Time

Loop Determines whether the LFO cycles repeatedly (loop) or only once (one shot).

Phase Determines the starting phase point for the LFO Wave when it is reset.

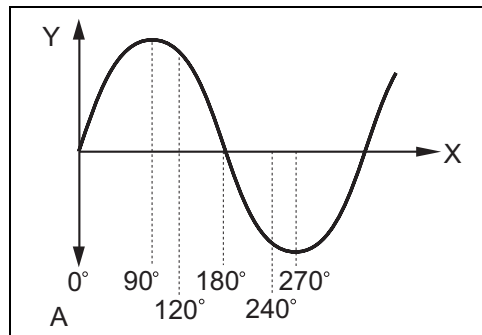

Figure 53: Phases of a wave

A: Phase
X: Time
Y: Level

LFO Phase Offset Determines the offset values of the Phase parameter for the respective Elements.

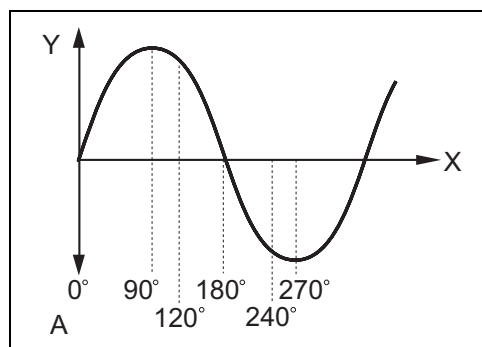

Figure 54: Phases of a wave

A: Phase
X: Time
Y: Level

Control Destination Determines the parameters which are to be controlled (modulated) by the LFO Wave.
The LFO Wave can control various parameters such as Amplitude modulation depth, Pitch modulation depth, Filter modulation depth and Resonance.

Control Depth Determines the LFO Wave Depth.

Depth Offset Determines the offset values of the Control Depth parameter for the respective Elements.
If the resultant Control Depth value is negative, it will be set to 0.
If the resultant Control Depth value is greater than 127, it will be set to 127.

1-3 Operational Parameters

1-3-1 General

Audition Phrase Number	Selects the Audition Phrase. The Preset programs provide several types of Audition Phrases.
Audition Phrase Note Shift	Determines the transpose setting for the amount (in semitones) by which the pitch of the Audition Phrase is raised or lowered.
Audition Phrase Velocity Shift	Adjusts the Velocity of the Audition Phrase between -63 and +63.
Assignable Switch 1 Mode / Assignable Switch 2 Mode	Determines whether the [ASSIGN 1] button and the [ASSIGN 2] button function as latch type or as momentary type. <ul style="list-style-type: none"> ■ Latch: Pressing the button alternates the lamp status between on and off. ■ Momentary: Pressing/holding the button turns the lamp on and releasing the button turns the lamp off.
Ribbon Controller Mode	Determines how the Ribbon Controller responds when released. <ul style="list-style-type: none"> ■ Reset: Releasing your finger from the Ribbon Controller automatically returns the value to the center. ■ Hold: Releasing your finger from the Ribbon Controller maintains the value at the last point of contact.
Motion Seq Hold Mode	Determines how the Motion Sequencer Hold button responds when pressed. <ul style="list-style-type: none"> ■ Latch: Pressing the button alternates the lamp status between on and off. ■ Momentary: Pressing/holding the button turns the lamp on and releasing the button turns the lamp off.

1-3-2 Part Setting

Mono/Poly	Selects monophonic or polyphonic. <ul style="list-style-type: none"> ■ Mono: The selected Part is played back monophonically; only a single note is played back simultaneously. ■ Poly: The selected Part is played back polyphonically; multiple notes or chords can be played back simultaneously. <p>For many instrument sounds (such as bass and synth lead), Mono allows a more natural and smooth sounding legato performance than Poly.</p>
Key Assign Mode	Determines the playing method when the same notes are received continuously, and without a corresponding note off message. <ul style="list-style-type: none"> ■ Single: If double playback of the same note is transmitted to the internal tone generator, the first note will be stopped and then the next note will be sounded. ■ Multi: When double playback of the same note is transmitted to the internal tone generator, all the notes are sounded simultaneously. <p>Single is useful when two or more instances of the same note are received nearly simultaneously, or without a corresponding note off message. To allow playback of each instance of the same note, set this to Multi.</p>

Arp Play Only	Determines whether or not the Part whose Arpeggio is set to On is played. If this parameter is set to On , the Part is played with Arpeggio. If set to Off , the Part makes no sound.
Element Pan Switch	Switches an Element Pan selected by Element Edit ([EDIT] → Part Selection → Element Selection → [Amplitude]→ [Level/Pan]) On or Off. When set to “off,” the Pan setting by Element Edit is set as the center position for the Pan.
Pitch Bend Range Upper / Pitch Bend Range Lower	Determines the maximum Pitch Bend Range in semitones. Examples: Setting the Upper parameter to +12 results in a maximum pitch rise of one octave when the Pitch Bend wheel is moved upwards. Setting the Lower parameter to -12 results in the pitch being lowered up to a maximum of one octave (12 semitones) when the Pitch Bend wheel is moved downwards.
Micro Tuning Number	Selects the Micro Tuning Number. The Preset Bank provides several types including the most common: Equal Temperament. See Section 1-3-4 Micro Tuning List.
Micro Tuning Root	Sets the base note for each scale. For some scales this setting may not be necessary.

1-3-3 Portamento

Portamento is used to create a smooth transition in pitch from one note played on the keyboard to the next one.

Portamento Master Switch	Determines whether Portamento is applied to all Parts or not.
Portamento Part Switch	Determines whether Portamento is applied to each Part or not, when the Portamento Master Switch is set to On.
Portamento Time	Determines the pitch transition time or rate when Portamento is applied. Higher values result in a longer pitch change time. The effect of the parameter depends on the settings of the Portamento Time Mode.
Portamento Mode	Determines how Portamento is applied to your keyboard performance. <ul style="list-style-type: none"> ■ Fingered: Portamento is only applied when you play legato (playing the next note before releasing the previous one). ■ Fulltime: Portamento is applied to all notes.
Portamento Time Mode	Determines how the pitch changes in time. <ul style="list-style-type: none"> Rate1: Pitch changes at the specified rate. Time1: Pitch changes in the specified time. Rate2: Pitch changes at the specified rate within an octave. Time2: Pitch changes in the specified time within an octave.
Legato Slope	Adjusts the attack of the Part for Mono legato playing. When the parameter Mono/Poly is set to Mono , legato playing may produce an unnatural attack depending on the waveform assigned to the selected Part. To solve such a problem, you can use this parameter to adjust the attack of the Part. Normally, this should be set to a low value for waveforms with short attack times, and to a high value for waveforms with long attack times.

1-3-4 Micro Tuning List

Equal Temperament	The pitch range of each octave is divided equally into twelve parts, with each halfstep evenly spaced in pitch. This is the most commonly used tuning in music today.
Pure Major, Pure Minor	These tunings preserve the pure mathematical intervals of each scale, especially for triad chords (root, third, fifth). You can hear this best in actual vocal harmonies — such as choirs and a cappella singing.
Werckmeister, Kirnberger, Vallotti & Young	Each of the scales combines the mean-tone and Pythagorean scales. The main feature of these scales is that each key has its own unique character. These scales were used extensively during the time of Bach and Beethoven, and even now they are often used when performing period music on the harpsichord.
1/4 shift	The normal equal-tempered scale, shifted up 50 cents.
1/4 tone	Twenty-four equally-spaced notes per octave. Play twenty-four notes within one octave.
1/8 tone	Forty-eight equally-spaced notes per octave. Play forty-eight notes within one octave.
Indian	Usually observed in Indian music. Play white keys only.
Arabic	Usually observed in Arabic music.

1-3-5 Arpeggio

This function lets you automatically trigger musical and rhythmic phrases and backing patterns using the current Performance by simply pressing a key or keys on the keyboard.

The Arpeggio sequence changes in response to the actual notes or chords you play, giving you a wide variety of inspiring musical phrases and ideas, both in composing and performing.

Arpeggio Master Switch	Determines whether Arpeggio for the entire Performance is On or Off.
Arpeggio Part Switch	Determines whether Arpeggio for the Part is On or Off.
Synchro Quantize Value	Determines the timing at which the next Arpeggio Type is switched during Arpeggio playback. If this is set to "off", the next Arpeggio playback starts as soon as each Part is played. The displayed value indicates clocks.
Arpeggio Hold	<p>Determines whether the Arpeggio continues cycling after the keys are released.</p> <ul style="list-style-type: none"> ■ Off: The Arpeggio plays only while you hold the keys. ■ On: The Arpeggio cycles automatically, even if you release your fingers from the keys. ■ Sync-off: Arpeggio playback continues to run silently, even when you release the keys. Pressing any key turns Arpeggio playback on again, and the Arpeggio is heard from the point in the cycle where playback is resumed.
Key Mode	<p>Determines how the Arpeggio plays back when playing the keyboard.</p> <ul style="list-style-type: none"> ■ Sort: When you play specific notes (for example, the notes of a chord), the same sequence plays, no matter what order you play the notes. ■ Thru: When you play specific notes (for example, the notes of a chord), the resulting sequence differs depending on the order of the notes. ■ Direct: Note events of the Arpeggio sequence do not play; only the notes you play on the keyboard are heard. When the Arpeggio plays back, events such as Pan and Brightness are applied to the sound of your keyboard performance. Use this setting when the Arpeggio types include Control Change data. ■ Sort+Drct: The Arpeggio is played back according to the Sort setting, and the notes played are also sounded. ■ Thru+Drct: The Arpeggio is played back according to the Thru setting, and the notes played are also sounded.
Change Timing	<p>Determines the actual timing at which the Arpeggio type is switched when you select another type during Arpeggio playback.</p> <ul style="list-style-type: none"> ■ Real-time: The Arpeggio type is switched immediately. ■ Measure: The Arpeggio type is switched at the top of the next measure.
Loop	<p>Determines whether the Arpeggio plays a single time or continuously, while notes are held.</p> <ul style="list-style-type: none"> ■ On: The Arpeggio cycles while notes are held. ■ Off: The Arpeggio plays only once even if notes are held.
Arpeggio Note Limit	<p>Determines the lowest and highest notes in the Arpeggio's note range. Notes played in this range trigger the Arpeggio. For example, setting a Note Limit of C5 - C4 lets you trigger the Arpeggio by playing notes in the two ranges of C-2 to C4 and C5 to G8; notes played between C4 and C5 have no effect on the Arpeggio.</p>

Arpeggio Velocity Limit	<p>Determines the lowest and highest Velocity that can trigger Arpeggio playback.</p> <p>This lets you set the Velocity range with which you press the key to trigger Arpeggio playback. You can also create separate low and high trigger ranges for the Arpeggio playback, with a Velocity “hole” in the middle, by specifying the maximum value first.</p> <p>For example, setting a Velocity Limit of 93 - 34 lets you play the Arpeggio from two separate Velocity ranges: soft (1 to 34) and hard (93 to 127). Notes played at middle Velocities (35 to 92) do not play the Arpeggio.</p>
Velocity Rate	<p>Determines how much the Velocity of Arpeggio playback is offset from the original value.</p> <ul style="list-style-type: none"> ■ 100%: The original Velocities are used. ■ Below 100%: Reduces the Velocities of the Arpeggio notes. ■ Above 100%: Increases the Velocities. <p>If the resulting Velocity value is 0, it will be set to 1; if the resulting Velocity value is greater than 127, it will be set to 127.</p>
Velocity Rate Offset	<p>Determines the Velocity Offset value of Arpeggio playback.</p> <p>If the resulting Velocity value is 0, it will be set to 1. If the resulting Velocity value is greater than 127 it will be set to 127.</p>
Gate Time Rate	<p>Determines how much the Gate Time (length) of the Arpeggio notes is offset from the original value.</p> <ul style="list-style-type: none"> ■ 100%: Indicates that the original Gate Times are used. ■ Below 100%: Shortens the Gate Times of the Arpeggio notes. ■ Above 100%: Lengthens the Gate Times of the Arpeggio notes. <p>The Gate Time cannot be decreased beyond its normal minimum of 1; any values outside that range will automatically be limited to the minimum.</p>
Gate Time Rate Offset	<p>Determines the Gate Time Rate Offset value of the Arpeggio notes.</p> <p>The Gate Time cannot be decreased beyond its normal minimum of 1; any values outside that range will automatically be limited to the minimum.</p>
Arp / Motion Seq Grid	<p>Determines to which beats the note data in the Arpeggio/Motion Sequencer will be aligned, or determines to which beats in the Arpeggio/Motion Sequencer the swing is applied.</p> <p>For Motion Sequencer, this value is set as one step length.</p>
Quantize Strength	<p>Sets the “strength” by which note events are pulled toward the nearest quantize beats.</p> <ul style="list-style-type: none"> ■ 0%: No quantization. ■ 50%: The note events are pulled halfway between 0% and 100%. ■ 100%: Exact timing as set by Quantize Value.
Unit Multiply	<p>Adjusts the Arpeggio playback time based on tempo.</p> <p>By using this parameter, you can create a different Arpeggio type from the original one.</p> <ul style="list-style-type: none"> ■ 200%: The playback time will be doubled and the tempo is halved. ■ 100%: The normal playback time. ■ 50%: The playback time will be halved and the tempo doubled.

Swing	<p>Delays notes on even-numbered beats (backbeats) to produce a swing feel.</p> <ul style="list-style-type: none"> ■ +1 and higher: Delay the Arpeggio notes. ■ -1 and lower: Advance the Arpeggio notes. ■ 0: Exact timing as set by Quantize Value, resulting in no swing. <p>Judicious use of this setting lets you create swing rhythms and triplet feels, such as shuffle and bounce.</p>
Output Octave Shift	Shifts the pitch of the Arpeggio up or down in octaves.
Octave Range	<p>Specifies the maximum Arpeggio range in octaves.</p> <ul style="list-style-type: none"> ■ Positive values: Increase the Octave Range of the Arpeggio playback. ■ Negative values: Decrease the Octave Range of the Arpeggio playback.
Velocity Mode	<p>Adjusts the Velocity of the Arpeggio notes.</p> <ul style="list-style-type: none"> ■ Original: The Arpeggio plays back at the preset Velocities included in the Arpeggio sequence data. ■ Thru: The Arpeggio plays back according to the Velocity of your playing. <p>For example, if you press the keys strongly, the playback volume of the Arpeggio is high.</p>
Trigger Mode	<p>Determines how Arpeggio playback is started and stopped.</p> <ul style="list-style-type: none"> ■ Gate: Pressing the key starts Arpeggio playback and releasing the note stops it. ■ Toggle: Pressing the key starts/stops Arpeggio playback and releasing the note does not affect Arpeggio playback. This Mode overrules the Arpeggio Hold setting. In other words, even when the Arpeggio Hold parameter is set to On, pressing the key start/stops Arpeggio playback. <p>Normally, this parameter should be set to Gate.</p>
Random SFX	<p>Determines whether Random SFX is active or not.</p> <p>Some Arpeggio types feature the Random SFX (Sound Effect) function, which will trigger a special sound when the note is released—for example, the fret noise of a guitar.</p>
Random SFX Velocity Offset	<p>Determines the offset value by which the Random SFX notes will be shifted from their original Velocities.</p> <p>If the resulting Velocity is 0, it will be set to 1.</p> <p>If the resulting Velocity is greater than 127, it will be set to 127.</p>
Random SFX Key On Control	<p>Defines the way in which the Velocity of the Random SFX special sound is determined.</p> <ul style="list-style-type: none"> ■ On: The Random SFX special sound is played with the Velocity generated when the key is pressed. ■ Off: The Random SFX special sound is played with a pre-programmed Velocity.
Accent Velocity Threshold	<p>Determines the minimum Velocity that will trigger the Accent Phrase.</p> <p>Some Arpeggio types include special sequence data called Accent Phrases, which will be played back only when Velocities higher than the specified threshold are received.</p>

Accent Start Quantize	<p>Determines the start timing of the Accent Phrase when the Velocity higher than the specified threshold in Accent Velocity Threshold is received.</p> <ul style="list-style-type: none"> ■ Off: The Accent Phrase starts as soon as the Velocity is received. ■ On: The Accent Phrase starts on the beat specified for each Arpeggio type after the Velocity is received.
Fixed SD/BD (for Drum Parts)	<p>Determines whether or not C1 and D1 are fixed as notes for Bass Drum (BD) and Snare Drum (SD) in Arpeggio playback.</p> <p>When this parameter is set to On, C1 will be used as the note of the Bass Drum and D1 will be used as the note of the Snare Drum in Arpeggio playback.</p> <p>Although most Drum Kits assign the Bass Drum sound to C1 and the Snare Drum to D1, certain Drum Kits additionally assign these sounds to other notes and certain Arpeggio Types are created by using those different notes. Accordingly, you may hear improper sounds depending on the selected Arpeggio Type and Drum Kit. Setting this parameter to On may solve such problems.</p>

1-3-6 Motion Sequencer

The Motion Sequencer feature lets you dynamically change sounds by operating parameters depending on sequences created in advance.

It provides real time control for changing sounds depending on various sequences such as Tempo, Arpeggio, or the rhythm of external connected devices.

You can assign desired sequence types for one Lane.

Motion Seq Master Switch	Determines whether the Motion Sequencer for the entire Performance is active or not.
Motion Seq Part Switch	Determines whether the Motion Sequencer for the selected Part is active or not.
Lane Switch	Determines whether each Lane is active or not.
Amplitude	<p>Determines the Amplitude change of the entire sequence. There are three parameters available for different ranges (below).</p> <ul style="list-style-type: none"> ■ Common Motion Seq Amplitude: Offsets the Amplitude of the Lane in the Performance when “MS FX” for the Lane is set on On. ■ Part Motion Seq Amplitude: Offsets the Amplitude of the Lane in the Part when “MS FX” for the Lane is set on On. ■ Motion Seq Amplitude: Determines the Amplitude of each Sequence.
Pulse Shape	<p>Determines the Pulse shape of the Sequence. There are two parameters available for different ranges (below).</p> <ul style="list-style-type: none"> ■ Common Motion Seq Pulse Shape: Offsets the Pulse Shape of the Lane parameter in the Performance when “MS FX” for the Lane is set to on and “Control” for the parameter is set on On. ■ Part Motion Seq Pulse Shape: Offsets the Pulse Shape of the Lane parameter in the Part when “Control” for the parameter is set on On.

Smoothness	<p>Determines the smoothness of the time change of the Sequence. There are three parameters available for different ranges (below).</p> <ul style="list-style-type: none"> ■ Common Motion Seq Smoothness: Offsets the Smoothness of the Lane in the Performance when “MS FX” for the Lane is set on On. ■ Part Motion Seq Smoothness: Offsets the Smoothness of the Lane in the Part when “MS FX” for the Lane is set on On. ■ Motion Seq Smoothness: Determines the Smoothness of each Sequence.
Random	<p>Determines how randomly change the Step Value is. There are two parameters available for different ranges (below).</p> <ul style="list-style-type: none"> ■ Common Motion Seq Random: Offsets the Random of the Lane in the Performance when “MS FX” for the Lane is set on On. ■ Motion Seq Random: Determines the Random setting of each Part.
Lane FX Receive	<p>Determines whether or not the Lane is affected by the knob operation of ARP/MS FX.</p> <ul style="list-style-type: none"> ■ On: The Lane is affected by parameter values of ARP/MS FX (Swing, Unit Multiply, Gate Time Rate, Velocity Rate, Amplitude, Pulse Shape, Smooth, and Random) and the operation of the [MOTION SEQ HOLD] button.
Lane Trigger Receive	<p>Determines whether the Lane responds to the MS Trigger or not.</p> <ul style="list-style-type: none"> ■ On: The Lane is affected by the operation of the [MOTION SEQ TRIGGER] button.
Lane Sync	<p>Determines if the playback of the Motion Sequence is synchronized to the tempo of the Performance, Beat, Part Arpeggio, or Lane 1 (only when any Lane other than Lane 1 is selected.)</p>
Lane Speed	<p>Determines the speed of the playback of the Motion Sequence. This parameter is active when the Lane Sync is set to “Off.”</p>
Lane Key On Reset	<p>Determines whether or not the playback of the Motion Sequence is stopped when you play the keyboard.</p> <ul style="list-style-type: none"> ■ Off: The playback of the Motion Sequence continues even after you play the keyboard. ■ Each-on: Each time you play the keyboard, the playback of the Motion Sequence is reset. Playback restarts from the first step. ■ 1st-on: When you play the first note on the keyboard, the playback of the Motion Sequence is reset and the playback starts from the first step. If you play a second note while the first is being held, the playback position of the Motion Sequence is not reset.
Lane Loop	<p>Determines the Motion Sequence is played only once or repeatedly.</p> <ul style="list-style-type: none"> ■ On: While you hold down the keys, the Motion Sequence is played repeatedly. ■ Off: Even if you hold down the keys, the Motion Sequence is played only once.

Lane Velocity Limit	<p>Determines the minimum and maximum Velocity values in which the Motion Sequence responds.</p> <p>The Motion Sequence will only be available for notes played between its specified Velocity Limits. In addition to this, if you first specify the maximum value then the minimum value which is actually higher than the maximum value, you can create two Velocity Limits to playback the Motion Sequence. For example, if you set 93 as the minimum and 34 as the maximum, then the Velocity range covers both “1 to 34” and “93 to 127,” with a Velocity “hole” in the middle. For that “hole” between the two Velocity Limits, the Motion Sequence will not be available.</p>
Lane Unit Multiply	<p>Adjusts the Motion Sequencer playback time based on tempo. By using this parameter, you can create a different Motion Sequencer type from the original one.</p> <ul style="list-style-type: none"> ■ 200%: The playback time will be doubled and the tempo is halved. ■ 100%: The normal playback time. ■ 50%: The playback time will be halved and the tempo doubled. ■ Common: The value set in the Unit Multiply common to the all Parts will be applied. ■ Arp: The value set in the Arpeggio Unit Multiply for the selected Part will be applied.

1-3-7 Controller Set

The controllers such as knobs on the front panel can be used to change and adjust a variety of parameters for each Part—both in real time and simultaneously. For example, keyboard aftertouch can be used to control vibrato and the Modulation Wheel can be used to control tonal brightness.

The function settings for all controllers are referred to as a Controller Set, and several Controller Sets can be created for each Part. The controller is referred to as Source, and the controlled function is referred to as Destination.

Source	<p>Determines which panel controller is to be assigned and used for the selected Controller Set.</p> <p>You can assign multiple functions to a controller.</p>
Destination	<p>Determines the parameter that is controlled by the Source.</p> <p>You can select any of the available parameters for each controller, such as volume, pitch and LFO depth.</p>
Element Switch	<p>Determines whether or not the selected controller affects each individual Element of the current Part.</p> <p>This parameter is disabled when the Destination is set to a parameter that is not related to the Part Elements.</p> <p>For the Normal Part (FM-X), this parameter is changed to “Operator Switch.”</p>

Curve Type

Determines the Curve type of the parameter which is set as the Destination.

■ **Standard:**

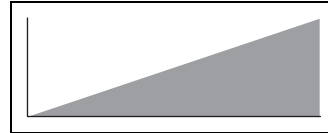

■ **Sigmoid:**

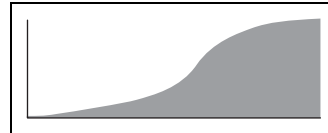

■ **Threshold:**

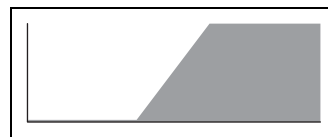

■ **Bell:**

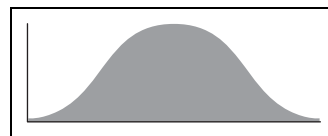

■ **Dogleg:**

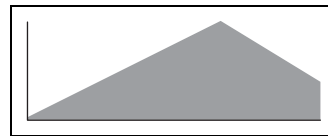

■ **FM:**

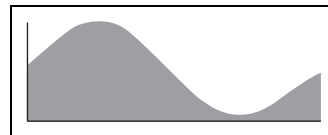

■ **AM:**

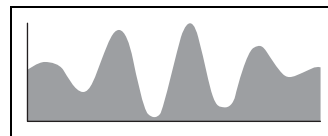

■ **M:**

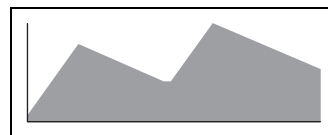

■ **Discrete Saw:**



■ Smooth Saw:

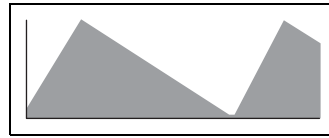

■ Triangle:

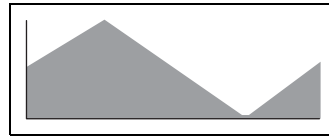

■ Square:

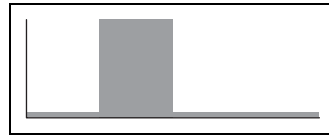

■ Trapezoid:

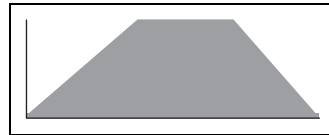

■ Tilt Sine:

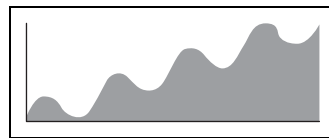

■ Bounce:

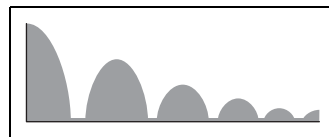

■ Resonance:

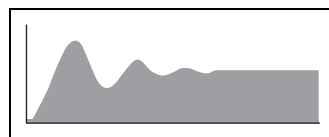

■ Sequence:

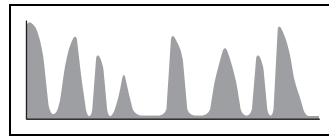

■ Hold:



Curve Polarity	Determines the Curve Polarity of the selected Curve type. <ul style="list-style-type: none"> ■ uni (unipolar): Unipolar changes only in a positive direction or in a negative direction from a base parameter value according to the Curve shape. ■ bi (bipolar): Bipolar changes in both of positive and negative directions from a base parameter value.
Curve Ratio	Determines the Curve ratio.
Curve Parameter	Adjusts the Curve shape. The number of Curve Parameters will change according to the Curve type.

1-3-8 Effect

The Effect unit applies Effects to the output of the tone generator block and audio input block, processing and enhancing the sound. Effects are applied in the final stages of editing, letting you change the sound of the created Part as desired.

The unprocessed sound is called “dry” sound, and the processed sound is referred to as “wet.”

Master Effect	Master effects are applied to the final output signal of the entire sound.
System Effect	System Effects are applied to the overall sound—for example, that of an entire Part, an entire Performance, etc. With System Effects, the sound of each Part is sent to the effect according to the Effect Send Level for each Part. The processed sound (referred to as “wet”) is sent back to the mixer, according to the Return Level, and output—after being mixed with the unprocessed “dry” sound. This arrangement lets you prepare an optimum balance of the effect sound and the original sound of the Parts.
Insertion Effect	Insertion Effects can be applied individually to each of specified Parts before merging the signals of all parts. This should be used for sounds for which you want to drastically change the character. The Insertion Effect has A and B units and those units can be separately set to different effects.
Side Chain/Modulator	The Side Chain/Modulator uses the output from one track to control an effect in a different track. You can specify the Effect type for activating the feature so that input signals for Parts other than the selected Part or the audio input signal can control the specified Effect. This trigger is called either “ Side Chain ” or “ Modulator ,” depending on the Effect Type.
Element Connection Switch	Determines which Insertion Effect (A or B) is used to process each individual Element of the current Normal Part (AWM2.) Set this to Thru to bypass the Insertion Effects for the specified element.
Drum Key Connection Switch	Determines which Insertion Effect (A or B) is used to process each individual Key of the current Drum Part or determines that no Insertion Effect is used. Parameters can be set for each Drum Key.
Insertion FX Switch	Determines whether or not each Insertion Effect (A or B) is applied.

Insertion Connection Type Lets you set the effect routing for Insertion Effects A and B.

- **Parallel** (for Normal Parts (AWM2) and Drum Parts): Signals processed with the Insertion Effect A and B blocks are sent to the Master Effect, Master EQ, Reverb, Variation, and Envelope Follower blocks.

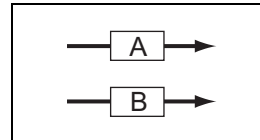

Figure 55: Insertion Effect Connection Parallel

- **Ins A>B**: Signals processed with the Insertion Effect A are sent to the Insertion Effect B and signals processed with the Insertion Effect B are sent to the Master Effect, Master EQ, Reverb, Variation, and Envelope Follower blocks.

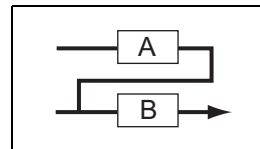

Figure 56: Insertion Effect Connection Ins A>B

- **Ins B>A**: Signals processed with the Insertion Effect B are sent to the Insertion Effect A and signals processed with the Insertion Effect A are sent to the Master Effect, Master EQ, Reverb, Variation, and Envelope Follower blocks.

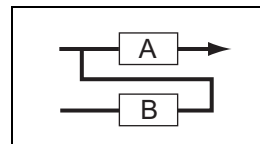

Figure 57: Insertion Effect Connection Ins B>A

Reverb	The Reverb System Effect block adds a warm ambience to the sound, simulating the complex reflections of actual performance spaces, such as a concert hall or a small club.
Reverb Send	Adjusts the reverb send level. The higher the value the deeper the Reverb.
Variation	The Variation System Effect block uses various type of modulation processing in addition to Chorus, Reverb, and Delay.
Variation Send	Adjusts the Variation Send level. The higher the value the deeper the Variation Effect.
Variation to Reverb	Determines the Send level of the signal sent from the Variation Effect to the Reverb Effect. The higher the value, the deeper the Reverb that is applied to the Variation processed signal.
Reverb Return	Determines the Return level of the Reverb Effect.
Variation Return	Determines the Return level of the Variation Effect.
Reverb Pan	Determines the pan position of the Reverb effect sound.
Variation Pan	Determines the pan position of the Variation effect sound.

1-3-9 EQ (Equalizer)

In general, an equalizer (EQ) is used to correct the sound output from amplifiers or speakers to match the special character of the room, or to change the tonal character of the sound. The sound is divided into several frequency bands, and adjustments are made to the sound by raising or lowering the level of each band. By adjusting the sound according to the genre (classical music being more refined, pop music more crisp, and rock music more dynamic) you can draw out the special characteristics of the music and make your performance more enjoyable.

2-band EQ	This Effect type is an equalizer that allows equalization of the Low and High bands. This is applied after the Insertion Effects.
3-band EQ	This Effect type is an equalizer that allows equalization of the Low, Mid, and High bands. This is applied before the Insertion Effects.
Boost 6, Boost 12, Boost 18	Boosts the entire band of the selected Element by +6dB, +12dB, and +18dB respectively.
Parametric EQ (PEQ)	Use this to attenuate or boost signal levels (gain) around the Frequency. An equalizer in which all of the parameters of equalization can be adjusted. The adjustable parameters include: <ul style="list-style-type: none"> ■ Center Frequency ■ Gain (boost/cut) of the Center Frequency ■ Bandwidth (see “Q”)

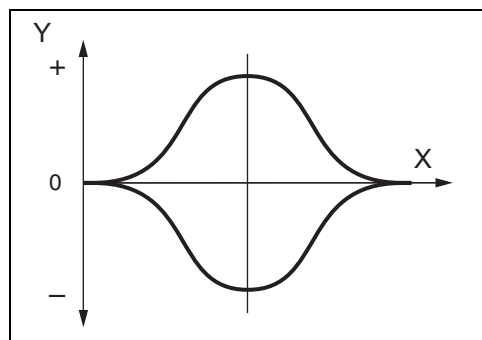

Figure 58: PEQ

Frequency	Determines the center frequency. Frequencies around this point are attenuated/boosted by the Gain setting.
Gain	Determines the level gain for the Frequency, or the amount the selected frequency band is attenuated or boosted.
Q	A parameter that determines the EQ bandwidth, or range of frequencies, to be attenuated/boosted. Consequently, this parameter determines the frequency characteristic curve. In case of the 3-band EQ, the Q setting is only available for the Mid band, which is a Peaking type EQ. The EQ Shape of the High and Low band is of the Shelving type. In case of the 2-band EQ, the Q setting is only available when Peak/Dip is selected as the EQ type.

1-3-10 Envelope Follower

Envelope Follower is a function for detecting the envelope of the input signal waveform and modifying sounds dynamically.

Envelope Follower Gain	Determines the output gain of the Envelope Follower.
Envelope Follower Attack	Determines the attack time of the Envelope Follower.
Envelope Follower Release	Determines the release time of the Envelope Follower.

2 Effects

2-1 Basic Terms

2-1-1 Definitions

VCM (Virtual Circuitry Modelling)	VCM is a technology that authentically models the elements in analog circuitry (such as resistors and capacitors). Effect types using the VCM technology produce the uniquely warm characteristics of vintage processing gear.
REV-X	REV-X is a Reverb algorithm developed by Yamaha. It provides a high-density, richly reverberant sound quality, with smooth attenuation, spread and depth that work together to enhance the original sound.

2-2 Effect Types

2-2-1 Reverb

Also called “reverberation,” this refers to the sound energy remaining in a room or closed space after the original sound stops. Similar to, yet different from echo, Reverb is the indirect, diffuse sound of reflections from the walls and ceiling that accompany the direct sound. The characteristics of this indirect sound depends on the size of the room or space and the materials and furnishings in the room.

HD HALL	Reverb emulating the acoustics of a concert hall.
REV-X HALL	Reverb emulating the acoustics of a concert hall using the REV-X technology.
R3 HALL	Reverb emulating the acoustics of a concert hall using the algorithm derived from the Yamaha ProR3.
SPX HALL	Reverb emulating the acoustics of a concert hall derived from the Yamaha SPX1000.
HD ROOM	Reverb emulating the acoustics of a room.
REV-X ROOM	Reverb emulating the acoustics of a room using REV-X technology.
R3 ROOM	Reverb emulating the acoustics of a room using the algorithm derived from the Yamaha ProR3.
SPX ROOM	Reverb emulating the acoustics of a room derived from the Yamaha SPX1000.
HD PLATE	Reverb emulating a metal plate.
R3 PLATE	Reverb emulating a metal plate using the algorithm derived from the Yamaha ProR3.
SPX STAGE	Reverb appropriate for a solo instrument derived from the Yamaha SPX1000.
SPACE SIMULATOR	Reverb that lets you set the space size by specifying the width, height, and depth.
GATED REVERB	Simulation of gated reverb.
REVERSE REVERB	Simulation of reverse playback of gated reverb.

2-2-2 Delay

An effect (or device) that delays an audio signal for ambient or rhythmic effects.

CROSS DELAY	The feedback of the two delayed sounds is crossed.
TEMPO CROSS DELAY	Tempo-synchronized Cross delay.
TEMPO DELAY MONO	Tempo-synchronized Mono delay.
TEMPO DELAY STEREO	Tempo-synchronized Stereo delay.
CONTROL DELAY	Delay with delay time that is controllable in real time.
DELAY LCR	Produces three delayed sounds: L, R and C (center).
DELAY LR	Produces two delayed sounds in stereo: L and R.
ANALOG DELAY RETRO	Analog delay driven by bucket-brigade device (BBD) chips with short delay setting.
ANALOG DELAY MODERN	Analog delay driven by bucket-brigade device (BBD) chips with long delay setting.

2-2-3 Chorus

Depending on the particular Chorus type and parameters, this can make a Voice sound “larger,” as if several identical instruments were playing in unison, or it can give a Voice greater warmth and depth.

G CHORUS	A Chorus Effect that produces a richer and more complex modulation than normal chorus.
2 MODULATOR	A Chorus Effect consisting of pitch modulation and amplitude modulation.
SPX CHORUS	An effect which uses a 3-phase LFO to add modulation and spaciousness to the sound.
SYMPHONIC	A 3-phase Chorus which uses a complex LFO wave.
ENSEMBLE DETUNE	Chorus effect without modulation, created by adding a slightly pitch-shifted sound.

2-2-4 Flanger

This effect creates a swirling, metallic sound.

VCM FLANGER	These effects emulate the characteristics of an analog flanger used in the 1970s, recreating a warm, high-quality flanger effect.
CLASSIC FLANGER	Conventional type of flanger.
TEMPO FLANGER	Tempo-synchronized flanger.
DYNAMIC FLANGER	Dynamically controlled flanger.
CONTROL FLANGER	Manually controlled flanger.

2-2-5 Phaser

Cyclically modulates the phase to add modulation to the sound.

VCM PHASER MONO	This effect emulates the characteristics of analog phasers used in the 1970s, recreating a warm, high-quality phaser effect. This is a mono phaser with VCM technology for producing a vintage sound.
VCM PHASER STEREO	This effect emulates the characteristics of analog phasers used in the 1970s, recreating a warm, high-quality phaser effect. This is a stereo phaser with VCM technology for producing a vintage sound.
TEMPO PHASER	Tempo-synchronized phaser.
DYNAMIC PHASER	Dynamically controlled phase shifter.
CONTROL PHASER	Manually controlled phaser.

2-2-6 Tremolo & Rotary

The Tremolo effect cyclically modulates the volume. The Rotary Speaker effect simulates the characteristic vibrato effect of a rotary speaker.

AUTO PAN	An effect which cyclically moves the sound left/right and front/back.
TREMOLO	An effect which cyclically modulates the volume.
ROTARY SPEAKER 1	Simulation of a rotary speaker.
ROTARY SPEAKER 2	Simulator of a rotary speaker including the amp block.

2-2-7 Distortion

This type can be used mainly for guitar, adding distortion with an edge to the sound.

AMP SIMULATOR 1	Simulation of a guitar amplifier.
AMP SIMULATOR 2	Simulation of a guitar amplifier.
COMP DISTORTION	Since a Compressor is included in the first stage, steady distortion can be produced regardless of changes in input level.
COMP DISTORTION DELAY	Compressor, Distortion and Delay are connected in series.
US COMBO	Simulation of an American combo amplifier.
JAZZ COMBO	Simulation of a jazz combo amplifier.
US HIGH GAIN	Simulation of an American high gain amplifier.
BRITISH LEAD	Simulation of a British stack amplifier.
MULTI FX	Multi effects processing for guitar sounds.
SMALL STEREO	Stereo distortion of guitar sounds.
BRITISH COMBO	Simulation of a British combo amplifier.
BRITISH LEGEND	Simulation of a British stack amplifier.

2-2-8 Compressor

Compressor is an effect commonly used to limit and compress the dynamics (softness/loudness) of an audio signal. When used with Gain to boost the overall level, this creates a more powerful, more consistently high-level sound. Compression can be used to increase sustain for electric guitar, smooth out the volume of a vocal, or bring a Drum Kit or rhythm pattern further up-front in the mix.

VCM COMPRESSOR 376 This effect emulates the characteristics of analog compressors—commonly used in recording studios. By squashing the dynamics, it thickens the sound, making it easier to boost in the mix, and is useful for drum and bass sounds.

CLASSIC COMPRESSOR Conventional compressor.

MULTI BAND COMP 3-band compressor.

UNI COMP DOWN Compressor using “downward” algorithm for making loud sounds quieter.

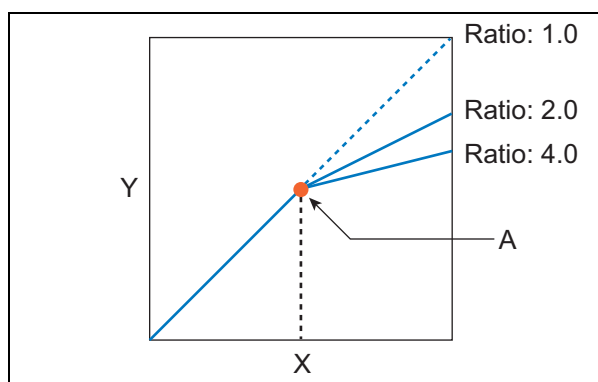

Figure 59: Uni Comp Down

A: Threshold
X: Input
Y: Output

UNI COMP UP Compressor using “upward” algorithm for making quiet sounds louder.

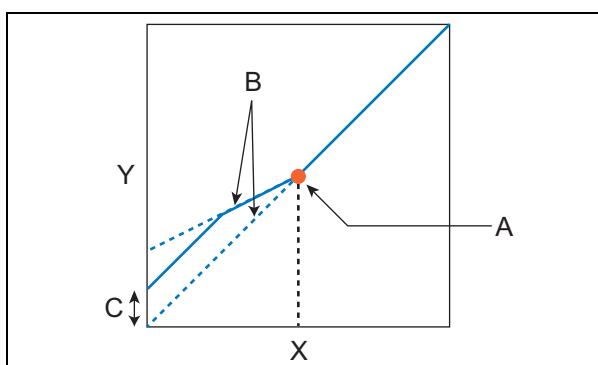

Figure 60: Uni Comp Up

- A:** Threshold
- B:** Ratio
- C:** Gain Limit
- X:** Input
- Y:** Output

PARALLEL COMP Compressor applying parallel processing of the compressed sounds and dry sounds.

2-2-9 Wah

This Effect cyclically modulates the tone brightness (Cutoff Frequency of a filter). Auto Wah modulates the tone via LFO, Touch Wah modulates the tone via volume and Pedal Wah modulates the tone by pedal control. These effects emulate the characteristics of analog wah effects used in the 1970s, recreating a warm, high-quality wah-wah effect.

VCM AUTO WAH	Modulates the tone via LFO.
VCM TOUCH WAH	Modulates the tone via Amplitude.
VCM PEDAL WAH	Modulates the tone via pedal control. To use this properly, assign the Pedal Control parameter of this Effect Type to the Foot Controller in the Controller Set display, then use the Foot Controller to control this effect in real time.

2-2-10 Lo-Fi

This Effect intentionally degrades the audio quality of the input signal via several methods such as lowering the sampling frequency.

LO-FI	Degrades the audio quality of the input signal to get a lo-fi sound.
NOISY	Adds noise to the current sound.
DIGITAL TURNTABLE	Simulates the noise of an analog record.
BIT CRUSHER	Produces distortion by reducing the resolution or bandwidth of the digital sound.

2-2-11 Tech

This Effect changes the tonal characteristics radically by using filtering and modulation.

RING MODULATOR	An effect that modifies the pitch by applying Amplitude Modulation to the frequency of the input.
DYNAMIC RING MODULATOR	Dynamically controlled Ring Modulator.
DYNAMIC FILTER	Dynamically controlled filter.
AUTO SYNTH	Processes the input signal into a synthesizer-type sound.
ISOLATOR	Controls the level of a specified frequency band of the input signal.
SLICE	Slices the Amplitude EG of the Voice sound.
TECH MODULATION	Adds a unique feeling of modulation similar to ring modulation.
CONTROL FILTER	Manually controlled filter.
VINYL BREAK	Simulates how a turntable slows down gradually (this causes the pitch to drop) before stopping.
BEAT REPEAT (EVEN)	Adds a mechanical beat by repeatedly playing sampled sounds. The beat is divided into even notes: 4ths, 8ths, or 16ths.
BEAT REPEAT (TRIPLET)	Adds a mechanical beat by repeatedly playing sampled sounds. The beat is divided into triple notes.
BEAT REPEAT (EVEN+TRIPLET)	Adds a mechanical beat by repeatedly playing sampled sounds. The beat has both even notes and triple notes.
BEAT REPEAT (FREE)	Adds a mechanical beat by repeatedly playing sampled sounds. The beat is more complex, allowing more unusual divisions, such as sextuplets or octuplets.
SPIRALIZER F	Unique filter applying Flanger processing with seemingly endless up/down pitch change.
TEMPO SPIRALIZER F	Spiralizer with tempo-synchronized LFO.
SPIRALIZER P	Unique filter applying Phaser processing with seemingly endless up/down pitch change.
TEMPO SPIRALIZER P	Spiralizer with tempo-synchronized LFO.

2-2-12 Misc

This category includes the other effect types.

VCM EQ 501	This effect emulates the characteristics of analog equalizers used in the 1970s, recreating warm, high-quality equalization.
PITCH CHANGE	Changes the pitch of the input signal.
EARLY REFLECTION	This effect isolates only the early reflection components of the Reverb.
HARMONIC ENHANCER	Layers additional harmonics to the input signal to make the sound stand out.
STEREOPHONIC OPTIMIZER	Adjusts the spacing of the sound and reproduces natural sound distance.
TALKING MODULATOR	Adds a vowel sound to the input signal.
DAMPER RESONANCE	Simulates the Resonance produced when the damper pedal of a piano is pressed.
NOISE GATE+COMP+EQ	This effect combines Noise Gate, Compressor and 3-Band EQ, to provide optimum processing of the microphone input, especially vocals.
PRESENCE	Effect for bringing out the hidden presence in the input sounds.
VOCODER	This effect extracts characteristics from the microphone sound and applies it to the Part played from the keyboard. This creates a distinctive, "robot voice" effect which is generated when you play the keyboard and sing or speak into the microphone at the same time.

2-3 Effect Parameters

2-3-1 A

AEG Phase	Offsets the phase of the Amplitude EG.
AM Depth	Determines the depth of Amplitude Modulation.
AM Inverse R	Determines the phase of the Amplitude Modulation for the R channel.
AM Speed	Determines the Amplitude Modulation speed.
AM Wave	Selects the wave for modulating the Amplitude.
AMP Type	Selects the amplifier type to be simulated.
Analog Feel	Adds the characteristics of an analog flanger to the sound.
Attack	Determines the amount of time that elapses between the playing of a key and the start of the compressor effect.
Attack Offset	Determines the amount of time that elapses between the playing of a key and the start of the wah effect.
Attack Time	[Dynamic Flanger, Dynamic Phaser, Dynamic Ring Modulator, Dynamic Filter] Determines the attack time of the envelope follower. [Beat Repeat] Determines the attack time of the gate effect for the entire sound.

2-3-2 B

Balance	Determines the balance of the low frequencies and the high frequencies.
Bass	Determines the sound quality at the low frequencies.
Bit	Lowers the resolution (bit accuracy) of the sound.
Bit Assign	Determines how Word Length is applied to the sound.
Bit Link	Determines the offset Bit value for the Side against the Mid when M/S (Mid/Side) is ON.
BPF1-10 Gain	Determines each output gain of BPFs 1 - 10 of the Vocoder effect.
Break	Sets Break point to On.
Brilliant	Determines the volume of the sound for which low frequencies are cut.

2-3-3 C

Chorus	Selects the Chorus type.
Click Density	Determines the frequency at which the click sounds.
Click Level	Determines the click level.
Clipper	Determines the extent to which the Clipper is applied for forcibly reducing the gain.
Clipper Source	Determines the signal to which the Clipper effect is applied for forcibly reducing the gain.
Color	Determines the fixed phase modulation. The Color parameter may not be effective depending on the values of the Mode and Stage parameters.
Common Release	Determines the amount of time that elapses between the releasing of a note and the end of the effect. This is a parameter of Multi Band Comp.
Compression	Determines the extent to which the compressor is applied.
Compress	Determines the minimum input level at which the compressor effect is applied.
Comp Attack	Determines the amount of time that elapses between the playing of a key and the start of the compressor effect.
Comp Level	Determines the output level of the compressor effect.
Comp Output Level	Determines the level of the signal output from the compressor effect.
Comp Ratio	Determines the ratio of the compressor.
Comp Release	Determines the amount of time that elapses between the release of a note and the end of the compressor effect.
Comp Sustain	Determines the amount of time of the compressor sustain.
Comp SW	Turns the compressor on or off.
Comp Threshold	Determines the minimum input level at which the compressor effect is applied.
Control Type	This is a parameter of Control Delay. <ul style="list-style-type: none"> ■ Normal: The delay effect is always applied to the sound. ■ Scratch: The delay effect is not applied if both the Delay Time and Delay Time Offset are set to 0.
Crush Type	Determines the Bit accuracy.
Curve	Determines the velocity curve toward the end of the sound.
Cut	Cuts the high frequencies.
Cutoff Frequency	Determines the Cutoff Frequency of the Filter for the effect sound.
Cutoff Frequency Control	Determines the Cutoff Frequency of the Filter.

2-3-4 D

Damper Control	When the half-damper compatible FC3 footswitch is connected to the instrument, the Damper Control parameter is controlled by the FC3, allowing for partial damper effects.
Decay	Controls how the Reverb sound decays.
Delay Control	Determines the depth/amount of the effect type selected by Delay SW.
Delay Input Level	Determines the delay input level.
Delay Level	Determines the level of the delayed sound.
Delay Level C	Determines the level of the delayed sound for the center channel.
Delay Mix	Determines the level of the delayed mixed sound when multiple effects are applied.
Delay Offset	Determines the offset value of the delay modulation.
Delay SW	Determines the delay type or modulation type.
Delay Time	Determines the delay of the sound in note value or absolute time.
Delay Time C, L, R	Determines the delay time for each channel: center, left and right.
Delay Time L>R	Determines the amount of time between the moment the sound is input from the L channel and the moment the sound is output to the R channel.
Delay Time Offset R	Determines the delay time for the R channel as offset.
Delay Time R>L	Determines the amount of time between the moment the sound is input from the R channel and the moment the sound is output to the L channel.
Delay Transition Rate	Determines the speed (rate) at which the delay time is changed from the current value to the specified new value.
Density	Determines the density of the reverberations or reflections.
Depth	Determines a specific value—usually the degree or intensity of the effect—depending on the selected Effect type. For Space Simulator, this parameter determines the depth of the simulated room. For VCM Flanger, this parameter determines the Amplitude of the LFO wave that controls the cyclic change of the delay modulation. For Phaser Type, this parameter determines the Amplitude of the LFO wave that controls the cyclic change of the phase modulation. For Jazz Combo, this parameter determines the depth of chorus/vibrato.
Detune	Determines the amount by which pitch is detuned.
Device	Selects the device for changing how to distort the sound.
Diffusion	For Reverb type, this parameter determines the spread of the reverb. For Tempo Phaser and Early Reflection, this parameter determines the spread of the selected effect.
Direction	For Flanger, Phaser, Wah and Filter effects, this parameter determines the direction of the modulation controlled by the envelope follower. For Tempo Spiralizer F and Tempo Spiralizer, this parameter determines the direction of the pitch shift.
Distortion	Determines the extent to which the sound is distorted.
Dist EQ	Switches the EQ type for adjusting the quality of the distorted sound.
Dist Drive	Controls the amount of the distortion.

Dist Presence	Determines each distortion type setting.
Dist SW	Switches the distortion types.
Dist Tone	Adjusts the distortion tone level.
Dist Type	Determines the distortion type.
Divide Freq High	Determines the high frequency for dividing the entire sound into three bands.
Divide Freq Low	Determines the low frequency for dividing the entire sound into three bands.
Divide Min Level	Determines the minimum level of the portions extracted via the Slice effect.
Divide Type	Determines how the sound (wave) is sliced by the note length.
Drive	Determines the extent of a series of specific effects. For Distortion effects, Noisy, Slice, and Rotary Speaker 2, this parameter determines the extent to which the sound is distorted. For one of the Miscellaneous effects, this parameter determines the extent to which the enhancer or talking modulator is applied.
Drive Horn	Determines the depth of the modulation generated via the rotation of the horn.
Drive Rotor	Determines the depth of the modulation generated via the rotation of the rotor.
Dry Level	Determines the level of the dry (unprocessed) sound.
Dry LPF Cutoff Frequency	Determines the Cutoff Frequency of the Low-Pass Filter applied to the dry sound.
Dry Mix Level	Determines the level of the dry sound.
Dry Send to Noise	Determines the level of the dry signal sent to the noise effect.
Dry/Wet	Determines the balance of the dry sound and the effect sound.
Dry/Wet Balance	Determines the balance of the dry sound and the effect sound.
Dyna Level Offset	Determines the offset value added to the output of the envelope follower.
Dyna Threshold Level	Determines the minimum level at which the envelope follower starts.

2-3-5 E

Edge	Sets the curve that determines how the sound is distorted.
Emphasis	Determines the change of the characteristics at high frequencies.
EQ Frequency	Determines the center frequency for each band of the EQ.
EQ Gain	Determines the level gain of the EQ center frequency for each band.
EQ High Frequency	Determines the center frequency of the high EQ band that is attenuated/boosted.
EQ High Gain	Determines the amount of boost or attenuation applied to the high EQ band.
EQ Low Frequency	Determines the center frequency of the low EQ band that is attenuated/boosted.
EQ Low Gain	Determines the amount of boost or attenuation applied to the low EQ band.

EQ Mid Frequency	Determines the center frequency of the middle EQ band that is attenuated/boosted.
EQ Mid Gain	Determines the amount of boost or attenuation applied to the middle EQ band.
EQ Mid Width	Determines the width of the middle EQ band.
EQ Width	Determines the width of the EQ band.
EQ1(LSH) Frequency	Determines the center frequency of the EQ1 (Low Shelving).
EQ1(LSH) Gain	Determines the level gain of the EQ1 (Low Shelving) center frequency.
EQ2 Frequency	Determines the center frequency of the EQ2.
EQ2 Gain	Determines the level gain of the EQ2 center frequency.
EQ2 Q	Determines the EQ2 bandwidth, or range of EQ2 frequencies.
EQ3 Frequency	Determines the center frequency of the EQ3.
EQ3 Gain	Determines the level gain of the EQ3 center frequency.
EQ3 Q	Determines the EQ3 bandwidth, or range of EQ3 frequencies.
EQ4 Frequency	Determines the center frequency of the EQ4.
EQ4 Gain	Determines the level gain of the EQ4 center frequency.
EQ4 Q	Determines the EQ4 bandwidth, or range of EQ4 frequencies.
EQ5(HSH) Frequency	Determines the center frequency of the EQ5 (High Shelving).
EQ5(HSH) Gain	Determines the level gain of the EQ5 (High Shelving) center frequency.
ER/Rev Balance	Determines the level balance of the early reflection and Reverb sounds.

2-3-6 F

F/R Depth	Determines the depth of the F/R (front/rear) pan. This parameter of Auto Pan is available when Pan Direction is set to L turn or R turn .
FB Hi Damp Offset R	Determines the amount of decay in high frequencies for the R channel as offset.
FB Level Offset R	Determines the feedback level for the R channel as offset.
Feedback	Determines the level of the sound signal output from the effect block and returned to its own input.
Feedback (Level)	Determines a specific value, depending on the selected Effect type. For the Reverb and Early Reflection effects, this parameter determines the feedback level of the initial delay. For the delay, chorus, flanger, comp distortion delay, and Tech effects, this parameter determines the feedback level output from the delay and returned to the input. For Analog Delay (Short) and Analog Delay (Long), this parameter determines the feedback level of the delayed sound. For Tempo Phaser and Dynamic Phaser, this parameter determines the feedback level output from the phaser and returned to the input.
Feedback High Damp	Determines the amount of decay of the high frequencies in the feedback sound.

Feedback Level 1, 2	Determines the feedback level of the delayed sound in each of the first series and second series.
Feedback Time	Determines the delay time of the feedback.
Feedback Time L, R	Determines the time of the feedback delay L and R.
Filter Output Level	Determines the output level of the Filter.
Filter Type	Determines a specific value, depending on the selected setting. For Lo-Fi, this parameter selects the tonal characteristic type. For Dynamic Filter and Control Filter, this parameter determines the Filter Type. For Beat Repeat, this parameter determines the filter type for the effected sound.
Fine 1, 2	Fine-tunes the pitch for each of the first series and second series.
Flanger Control	Determines the delay value (the value of the Comb Filter) of the delay modulation.
Formant Offset	This Vocoder parameter adds the offset value to the Cutoff Frequency of BPF for the Inst input.
Formant Shift	This Vocoder parameter shifts the Cutoff Frequency of the BPF for Inst input.
Freeze	When this parameter is set to On, the effect repeats until the parameter is set to Off.

2-3-7 G

Gain	Determines the level gain of the pre-amplifier.
Gain Boost	Switches the level gain of the power amplifier.
Gain Limit	Determines the maximum gain level.
Gate Time	For Slice, this parameter determines the gate time of the sliced portion. For Beat Repeat, this parameter determines the gate time of the entire sound.

2-3-8 H

Height	Determines the height of the simulated room.
High Attack	Determines the amount of time from the moment a key is pressed to the moment the compressor is applied to the high frequencies.
High Cut	Cuts the level of the high frequencies.
High Damp Frequency	Determines the characteristic of the high frequencies.
High Gain	Determines the output gain for the high frequencies.
High Level	Determines the level of the high frequencies.
High Mute	Switches the mute status of the high frequencies.
High Ratio	Determines a specific value, depending on the selected Effect type. For REV-X Hall, REV-X Room, HD Hall, HD Room, and HD Plate, this parameter determines the ratio of the high frequencies. For Multi-band Comp, this parameter determines the ratio of the compressor for the high frequencies.

High Subband Gain Lch, Rch	Determines the gain level of the high frequencies for the stereo sound (R and L channels).
High Threshold	Determines the minimum input level at which the effect is applied to the high frequencies.
High Treble	Determines the gain of the high frequencies which is higher than the treble setting.
Horn Fast	Determines the frequency of the horn (higher range) when the Speed Control is set to Fast.
Horn Fast/Slow	Determines how long it takes for the rotation speed of the horn (higher range) to change from Fast to Slow when the rotation speed is switched.
Horn Slow	Determines the frequency of the horn (higher range) when the Speed Control is set to Slow.
Horn Slow/Fast	Determines how long it takes for the rotation speed of the horn (higher range) to change from Slow to Fast when the rotation speed is switched.
Horn Speed Fast	Determines the speed of the horn when the slow/fast switch is set to Fast.
Horn Speed Slow	Determines the speed of the horn when the slow/fast switch is set to Slow.
HPF Cutoff Frequency	Determines a specific value, depending on the selected Effect type. For Reverb type, tech type, or misc type, this parameter determines the Cutoff Frequency of the High-Pass Filter. For Vocoder, this parameter determines the Cutoff Frequency for the High-Pass Filter applied to the microphone sound.
HPF Output Level	Determines how much the output from High-Pass Filter is mixed with the output from the Vocoder.

2-3-9 I

Initial Delay	Determines the amount of time that elapses between the direct, original sound and the initial reflections.
Initial Delay 1, 2	Determines the delay time until the initial reflection for each of the first series and second series.
Initial Delay Lch, Rch	Determines the amount of time that elapses between the direct, original sound and the initial reflections (echoes) that follow it for each of R and L channels.
Input Level	Determines the input level of the signal.
Input Mode	Selects mono or stereo configuration for the input sound.
Input Select	Selects an input channel.
Inst Level	Determines the level of the keyboard performance sound which is to be input to the Vocoder.

2-3-10 K

Knee	Determines how the transition range changes around the threshold. The higher the value, the shallower the transition curve.
-------------	---

2-3-11 L

L/R Depth	Determines the depth of the L/R pan effect.
L/R Diffusion	Determines the spread of the sound.
Lag	Determines the lag time that is additionally applied to the delayed sound specified via a note length.
Length	Determines the amount of time for repeating.
Length Change Quantize	Quantizes the timing for changing the length parameter.
LFO Depth	Determines a specific value, depending on the selected Effect type. For SPX Chorus, Symphonic, Classic Flanger, and Ring Modulator, this parameter determines the depth of the modulation. For Tempo Phase, this parameter determines the frequency of the phase modulation.
LFO Phase Difference	Determines the L/R phase difference of the modulated wave.
LFO Phase Reset	Determines how the initial phase of the LFO is reset.
LFO Speed	Determines a specific value, depending on the selected Effect type. For Chorus effects, Flanger effects, Tremolo and Ring Modulator, this parameter determines the frequency of the modulation. For Tempo Phaser and Tempo Flanger, this parameter determines the modulation speed via a note type. For Auto Pan, this parameter determines the frequency of the Auto Pan.
LFO Wave	Determines a specific value, depending on the selected Effect type. For Flanger effects and Ring Modulator, this parameter selects the wave for modulation. For Auto Pan, this parameter determines the panning curve. For VCM Auto Wah, this parameter selects the wave: sine or square.
Liveness	Determines the decay characteristic of Early Reflection.
Low Attack	Determines the amount of time from the moment a key is pressed to the moment the compressor is applied to the low frequencies.
Low Cut	Cuts the level of the low frequencies.
Low Gain	Determines the output gain for the low frequencies.
Low Level	Determines the output level for the low frequencies.
Low Mute	Switches the mute status of the low frequencies.
Low Ratio	Determines the ratio of low frequencies. When "REV-X Hall" or "REV-X Room" is selected, this parameter determines the ratio of the low frequencies. When "Multi-band Comp" is selected, this parameter determines the ratio of the compressor for the low frequencies.
Low Subband Gain Lch, Rch	Determines the gain level of the low frequencies for the stereo sound (R and L channels).
Low Threshold	Determines the minimum input level at which the effect is applied to the low frequencies.

Lower Range	[VCM Auto Wah, VCM Touch Wah, VCM Pedal Wah] Determines the minimum value of the wah filter. The Bottom parameter is available only when the value is less than that of the Top parameter. [Control Flanger] Determines the minimum value of Flange Control. [Control Phaser] Determines the minimum value of Phase Control. [Control Filter] Determines the minimum value of Cutoff Frequency Control.
LPF Cutoff Frequency	Determines the Cutoff Frequency of the Low-Pass Filter.
LPF Resonance	Determines the resonance of the low pass filter for the input sound.

2-3-12 M

Manual	Determines a specific value, depending on the selected Effect type. For VCM Flanger, this parameter determines the offset value of the delay modulation. For VCM Phaser mono and VCM Phaser stereo, this parameter determines the offset value of the phase modulation.
Make Up Gain	Determines the output gain of the compressor block.
Master Volume	Determines the gain level of the power amplifier.
Mic Output Gate Switch	<ul style="list-style-type: none"> ■ Off: Always passes HPF output and “Noise Generator” output. ■ On: Passes HPF output and Noise Generator output when there is audio input data in “Inst.”
Mic Input Level	Determines the input level of the microphone sound.
Mic L-R Angle	Determines the L/R angle of the microphone.
Mic Position	Determines the relative position of the microphone to the speaker.
Mid	Determines the characteristic of the mid frequencies.
Mid Attack	Determines the amount of time from the moment a key is pressed to the moment the compressor is applied to the mid frequencies.
Mid Cut	Cuts the level of the mid frequencies.
Mid Gain	Determines the output gain for the mid frequencies.
Mid Level	Determines the output level for the mid frequencies.
Mid Mute	Switches the mute status of the mid frequencies.
Mid Ratio	Determines the ratio of the compressor for the mid frequencies.
Mid Sweep	Determines the frequency range over which the mid frequencies are cut.
Mid Threshold	Determines the minimum input level at which the effect is applied for the mid frequencies.
Mid Width	Determines the bandwidth to cut the mid frequencies.
Mix	Determines the volume of the effect sound.
Mix Level	Determines the level of the effect sound mixed with the dry sound.
Mid1 Subband Gain Lch, Rch	Determines the gain level of the Mid1 frequencies for the stereo sound (R and L channels).
Mid2 Subband Gain Lch, Rch	Determines the gain level of the Mid2 frequencies for the stereo sound (R and L channels).

Mid3 Subband Gain Lch, Rch	Determines the gain level of the Mid3 frequencies for the stereo sound (R and L channels).
Mod Depth	Determines the depth of the modulation.
Mod Depth Offset R	Determines the depth of the modulation for R channel as offset.
Mod Feedback	Determines the feedback level to the modulation.
Mod Gain	Determines the gain of the modulation.
Mod LPF Cutoff Frequency	Determines the Cutoff Frequency of the Low-Pass Filter applied to the modulated sound.
Mod LPF Resonance	Determines the Resonance of the Low-Pass Filter for the modulated sound.
Mod Mix Balance	Determines the mix balance of the modulated element.
Mod Speed	Determines the modulation speed.
Mod Wave Type	Selects the wave type for modulation.
Mode	For VCM Phaser Mono and VCM Phaser Stereo, this parameter determines the phaser type, or more specifically, the factor for forming the phaser effect. For British Combo, this parameter switches the pre-amplifier.
Modulation Phase	Determines the L/R phase difference of the modulated wave.
Modulator Input Level	Determines the input level of the modulator.
Move Speed	Determines how long it takes to move the sound from the current status to the sound specified via the Vowel parameter.
M/S	When this parameter is set to On, each sound (center, left and right) is modulated, respectively.

2-3-13 N

Noise Gate Attack	Determines the amount of time that elapses between the playing of a key and the start of the Noise Gate effect.
Noise Gate Release	Determines the amount of time that elapses between the releasing of a note and the end of the Noise Gate effect.
Noise Gate Threshold	Determines the minimum input level at which the Noise Gate effect is applied.
Noise Level	Determines the noise level.
Noise LPF Cutoff Frequency	Determines the Cutoff Frequency of the Low-Pass Filter applied to the noise.
Noise LPF Q	Determines the Resonance of the Low-Pass Filter applied to the noise.
Noise Mod Depth	Determines the depth of the noise modulation.
Noise Mod Speed	Determines the speed of the noise modulation.
Noise Tone	Determines the tonal characteristics of the noise.
Normal	Determines the volume of the standard sound.

2-3-14 O

Offset	Determines the starting pitch in semitones.
Ofs Transition	Determines the time that elapses after the Offset value changes.
On/Off Switch	For the Isolator, turns the isolator on or off. For the Stereophonic Optimizer, turns the effect on or off.
OSC Frequency Coarse	Determines the frequency at which the sine wave modulates the amplitude of the input wave.
OSC Frequency Fine	Fine-tunes the frequency at which the sine wave modulates the amplitude of the input wave.
Output	Determines the level of the signal output from the effect block.
Output Level	Determines the level of the signal output from the effect block.
Output Level 1, 2	Determines the level of the signal output from the first block and second block, respectively.
Overdrive	Determines the degree and character of the distortion effect.

2-3-15 P

Pan 1, 2	Determines the pan setting for each of the first series and second series.
Pan AEG Min Level	This parameter of the Slice effect determines the minimum level of the Amplitude EG applied to the panned sound.
Pan AEG Type	This parameter of the Slice effect determines the type of the Amplitude EG applied to the panned sound.
Pan Depth	Determines the depth of the pan effect.
Pan Direction	Determines the direction toward which the stereo pan position of the sound moves.
Pan Type	Determines the pan type.
Panning	Determines the spread of the chorus/vibrato.
Pedal Control	Determines the Cutoff Frequency of the wah filter. For best results, assign this parameter to the Foot Controller in the Controller Set display, then use the Foot Controller to control this parameter.
Phase Control	Determines the depth of phase modulation.
Phase Shift Offset	Determines the offset value of the phase modulation.
Phaser SW	Determines the Phaser type
Pitch 1, 2	Determines the pitch in semitones for each of the first series and second series.
Pitch Sweep	Sets the pitch to change gradually in each repetition.
Plate Type	Determines the sound echo type.
Play Speed	Determines the playback speed.
PM Depth	Determines the depth of the pitch modulation.
Post-comp HPF	Determines the Cutoff Frequency of the High-Pass Filter which follows the compressor.
Preamp	Determines the gain level of the pre-amplifier.

Pre Mod HPF Cutoff Frequency	Determines the Cutoff Frequency of the High-Pass Filter before modulation is applied.
Pre-LPF Cutoff Frequency	Determines the Cutoff Frequency of the Low-Pass Filter before modulation is applied.
Pre-LPF Resonance	Determines the Resonance of the Low-Pass Filter for the input sound.
Presence	For Amp Simulator effects this parameter controls high frequencies. For Presence, this parameter determines the extent to which the effect is applied.

2-3-16 R

R/H Balance	Determines the volume balance of the horn (higher range) and rotor (lower range).
Random	Creates random repetition.
Ratio	Determines the ratio of the compressor.
Release	Determines the amount of time that elapses between the releasing of a key and the end of the compressor effect.
Release Curve	Determines the release curve of the envelope follower.
Release Time	For Dynamic Flanger, Dynamic Phaser, Dynamic Ring Modulator, and Dynamic Filter, this parameter determines the release time of the envelope follower. For Beat Repeat, this parameter determines the release time of the gate for the entire sound.
Repeat	Determines whether Repeat is active or not.
Resonance	For Dynamic Filter and Control Filter, this parameter determines the Resonance of the filter. For Beat Repeat, the parameter determines the Resonance of the filter for the effected sound.
Resonance Offset	Determines the Resonance as offset.
Retrigger Attack Time	Determines the attack time of the gate for the entire sound.
Retrigger Cycle	Determines the cycle for repeating.
Retrigger Gate Time	Determines the gate time for the entire sound.
Retrigger Release Time	Determines the release time of the gate for the entire sound.
Retrigger Quantize	When this parameter is set to On, the sequencer is repeated at the top of the measure.
Reverb Delay	Determines the delay time from the early reflections until the reverberations.
Reverb Time	Determines the Reverb time.
Reverse	Repeats reverse playback.
Room Size	Determines the size of the room in which the instrument sounds.
Rotor Fast	Determines the frequency of the rotor (lower range) when the Speed Control is set to Fast.
Rotor Slow	Determines the frequency of the rotor (lower range) when the Speed Control is set to Slow.

Rotor Speed Fast	Determines the speed of the rotor when the slow/fast switch is set to Fast.
Rotor Speed Slow	Determines the speed of the rotor when the slow/fast switch is set to Slow.
Rotor/Horn Balance	Determines the volume balance of the horn and rotor.
Rtr Fast/Slow	Determines how long it takes for the rotation speed of the rotor (lower range) to change from Fast to Slow when the rotation speed is switched.
Rtr Slow/Fast	Determines how long it takes for the rotation speed of the rotor (lower range) to change from Slow to Fast when the rotation speed is switched.

2-3-17 S

Sample Rate	Lowers the Sample Rate.
Sample Rate Link	Determines the offset value of the Sample Rate for the Side against the Mid when M/S (Mid/Side) is ON.
Sampling Frequency Control	Controls the sampling frequency.
Scale Type	Determines how the pitch changes when "Step Mode" is set to "Scale."
SC EQ Freq	Determines the center frequency of the Side Chain EQ.
SC EQ Gain	Determines the level gain of the Side Chain EQ.
SC EQ Q	Determines the Side Chain EQ bandwidth.
Semitones	Determines the pitch shift range when "Step Mode" is set to "Semitone."
Sensitivity	Determines a specific value, depending on the selected Effect type. For Dynamic Flanger, Dynamic Phaser, and the Tech effects, this parameter determines the sensitivity of the modulation applied to the input change. For VCM Touch Wah effects, this parameter determines the sensitivity of the wah filter's change applied to the input change. For British Combo effect, this parameter switches the gain level of the pre-amplifier.
Side Bit	Lowers the resolution (bit accuracy) for the Side chain.
Side Chain EQ	When this is turned on, the EQ is applied for the corresponding input level range of the Side Chain.
Side Chain Lvl	Determines the Side chain input level.
Side Chain Input Level	Determines the Side chain input level.
Side Sample Rate	Lowers the Sample rate for the Side chain.
Slow-Fast Time of Horn	Determines how long it takes for the rotation speed of the horn to change from the current speed (slow or fast) to the other one (fast or slow) when the rotation speed is switched.
Slow-Fast Time of Rotor	Determines how long it takes for the rotation speed of the rotor to change from the current speed (slow or fast) to another one (fast or slow) when the rotation speed is switched.
Space Type	Selects the type of space simulation.
Speaker Air	Determines the characteristic of the speaker cabinet.

Speaker Type	For Amp Simulator 1 and Comp Distortion Delay, this parameter selects the type of speaker simulation. For US Combo, Jazz Combo, US High Gain, British Lead, Small Stereo, British Combo, British Legend, and Multi FX, this parameter selects the speaker type.
Speed	Determines a specific value, depending on the selected Effect type. For VCM Flanger, this parameter determines the frequency of the LFO wave which controls the cyclic change of the delay modulation. For Phaser, this parameter determines the frequency of the LFO wave which controls the cyclic change of the phase modulation. For VCM Auto Wah, this parameter determines the speed of the LFO. For Vinyl Break, this parameter determines the amount of time between the moment the sound starts and the moment the sound is stopped.
Speed Adjust	For fine adjustment of the speed.
Speed Control	Switches the rotary speed.
Spiral	Turn the LFO On/Off.
Spiral Sync	Determines the basic time period over which the pitch shifts step by step.
Spread	Determines the spread of the sound.
Stage	Determines the step number of the phase shifter.
Step Mode	Determines whether the pitch shifts smoothly or step by step.
Step Transition	Determines how long it takes for the pitch to change to the next pitch when the pitch shifts step by step.

2-3-18 T

Texture	Determines the texture of the sound effect.
Treble	Determines the gain of the high frequencies.
Threshold	Determines the minimum input level at which the effect is applied.
Time Sweep	Determines the gradual change of the time length in each repetition.
Tone Shift	Switches the characteristic of the Tone control.
Type	Determines a specific value, depending on the selected Effect type. For VCM Flanger, this parameter determines the flanger type. For Wah effects, this parameter determines the type of the Auto Wah. For Early Reflection, Gated Reverb, and Reverse Reverb, this parameter determines the type of the reflection sound. For US High Gain and British Lead, this parameter switches the type of the amplifier. For Analog Delay (Short) and Analog Delay (Long), this parameter determines the characteristic of the delay effect. For Parallel Comp, this parameter determines the compressor type.

2-3-19 U

Upper Range	For VCM Auto Wah, VCM Touch Wah, and VCM Pedal Wah, this parameter determines the maximum value of the wah filter. For Control Flanger, this parameter determines the maximum value of the Flange Control. For Control Phaser, this parameter determines the maximum value of the Phase Control.
--------------------	--

2-3-20 V

Vib Speed	Determines the speed of the vibrato. This parameter is active when Chorus is set to "Vib."
Vocoder Attack	Determines the Attack Time of the Vocoder sound. The higher the value, the slower the attack.
Vocoder Release	Determines the Release Time of the Vocoder sound. The higher the value, the slower the decay.
Volume	Determines the volume of the re-amp.
Vowel	Selects a vowel type.

2-3-21 W

Wah Pedal	Determines the position of the wah pedal.
Wah SW	Determines the type of the wah effect.
Wall Vary	Determines the wall status of the simulated room. Higher values produce more diffuse reflections.
Width	Determines the width of the simulated room.
Width Low	Determines the stereo balance of the low frequencies.
Width Mid1, 2, 3	Determines the stereo balance of the Mid1, Mid2, and Mid3 frequencies.
Width High	Determines the stereo balance of the high frequencies.
Word Length	Determines the degree of sound roughness.

3 MIDI

3-1 Overview

3-1-1 About MIDI

MIDI (Musical Instrument Digital Interface) is a standard that allows electronic musical instruments to communicate with each other, by sending and receiving compatible types of MIDI data or messages. The types of MIDI data include Note, Control Change, Program Change and various other types.

This synthesizer can control other MIDI devices by transmitting note-related data and various types of controller data. It can also be controlled by incoming MIDI messages which automatically determine the tone generator mode, select MIDI channels, Parts and Effects, change parameter values, and of course play the Parts.

3-1-2 MIDI channels

MIDI performance data is assigned to one of sixteen MIDI channels. Using these channels, 1 through 16, the performance data for sixteen different instrument parts can be simultaneously sent over one MIDI cable.

Think of the MIDI channels as TV channels. Each TV station transmits its broadcasts over a specific channel. Your home TV set receives many different programs simultaneously from several TV stations and you select the appropriate channel to watch the desired program. MIDI operates on the same basic principle.

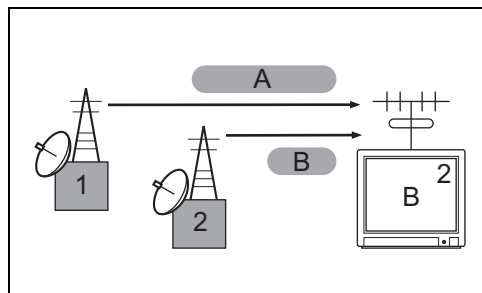

Figure 61: MIDI Channels

A: Weather Report

B: News

The transmitting instrument sends MIDI data on a specific MIDI channel (MIDI Transmit Channel) via a single MIDI cable to the receiving instrument. If the receiving instrument's MIDI channel (MIDI Receive Channel) matches the Transmit Channel, the receiving instrument will sound according to the data sent by the transmitting instrument.

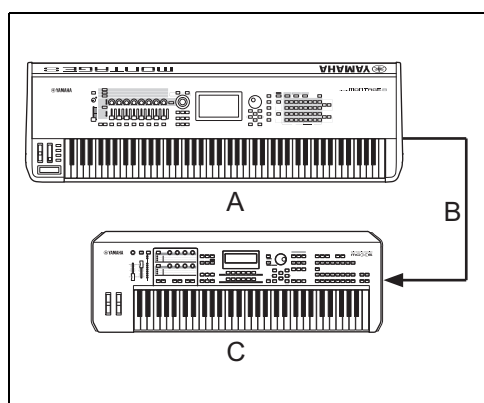

Figure 62: MIDI Cable

- A: MIDI Transmit channel 2
- B: MIDI cable
- C: MIDI Receive channel 2

3-1-3 MIDI ports

The above-mentioned sixteen-channel limit can be overcome by using separate MIDI “ports,” each supporting sixteen channels. While a single MIDI cable is equipped to handle data over up to sixteen channels simultaneously, a USB connection is capable of handling far more, thanks to the use of MIDI ports. Each MIDI port can handle sixteen channels, and the USB connection allows up to eight ports, enabling you to use up to 128 channels on your computer.

3-1-4 MIDI messages

MIDI messages can be divided into two groups:

- Channel messages (see section 3-2 Channel Messages) and
- System messages (see section 3-3 System Messages).

The following explanations show examples of MIDI messages. For more details about MIDI messages (for example, for editing recorded MIDI data) please refer to any of the fine MIDI guidebooks that are commercially available.

3-2 Channel Messages

3-2-1 Note On/Off

Messages which are generated when the keyboard is played:

- Note On: Generated when a key is pressed.
- Note Off: Generated when a key is released.

Each message includes a specific note number, which corresponds to the key that is pressed, plus a Velocity value based on how hard the key is struck.

Reception note range = C -2 (0) - G8 (127); C3 = 60

Velocity range = 1 - 127 (only Note On Velocity is received)

3-2-2 Pitch Bend

Pitch Bend messages are continuous controller messages that allow the pitch of designated notes to be raised or lowered by a specified amount over a specified duration.

This message is a numerical representation of pitch bend wheel position.

3-2-3 Program Change

Messages that determine which Performance to select for each part. In combination with Bank Select, you can select not only basic Performance numbers, but also variation Performance bank numbers.



When you specify Program Change as a number in the range of 0 - 127, make sure to specify a number that is one less than the program number listed in the Performance List. (The program numbers for this instrument begin with 1.) For example, to specify program number 128, you would actually enter Program Change 127.

3-2-4 Control Change

Control Change messages let you select a Performance bank, control volume, panning, modulation, portamento time, brightness, and various other controller parameters, through specific Control Change numbers.

Each Control Change number corresponds to a specific parameter.

Bank Select MSB (Control #0) and Bank Select LSB (Control #32)

Messages that select variation Performance bank numbers by combining and sending the MSB and LSB from an external device.

The functions of MSB and LSB messages differ depending on the tone generator mode:

- MSB numbers select Performance Type.
- LSB numbers select Performance banks.

A new bank selection will not become effective until the next Program Change message is received.

To change the Performances (including the Performance banks), transmit Bank Select MSB, LSB, then Program Change in this order as a set.

Modulation (Control #1)

Messages that control parameters using the Modulation Wheel.

- **127**: Maximum vibrato.
 - **0**: No change.
-

Portamento Time (Control #5)	<p>Messages that control the duration of portamento, or a continuous pitch glide between successively played notes.</p> <ul style="list-style-type: none"> ■ 127: Maximum portamento time. ■ 0: Minimum portamento time. <p>When the parameter Portamento Switch (Control #65) is set to On, the value set here can adjust the speed of the pitch change.</p>
Data Entry MSB (Control #6) and Data Entry LSB (Control #38)	<p>These parameters specify the value of RPN MSB and RPN LSB events. The parameter value is determined by combining the MSB and LSB.</p>
Main Volume (Control #7)	<p>Messages that control the volume of each part.</p> <ul style="list-style-type: none"> ■ 127: Maximum volume. ■ 0: Volume off. <p>This provides detailed control over the level balance among the parts.</p>
Pan (Control #10)	<p>Messages that control the stereo panning position of each part (for stereo output).</p> <ul style="list-style-type: none"> ■ 127: Positions the sound to the far right. ■ 0: Positions the sound to the far left.
Expression (Control #11)	<p>Messages that control intonation expression of each part during performance.</p> <p>This parameter produces volume variations during playback:</p> <ul style="list-style-type: none"> ■ 127: Maximum volume. ■ 0: Volume off.
Hold1 (Control #64)	<p>Messages that control sustain on/off.</p> <p>Notes playing when the pedal is pressed will be sustained.</p> <ul style="list-style-type: none"> ■ 64 - 127: Sustain on. ■ 0 - 63: Sustain off. <p>When the pedal supports half-damper playing, the control of sustain is continuous, and not a simple switch. In other words, higher values results in longer sustain time and lower values result in shorter sustain.</p>
Portamento (Control #65)	<p>Messages that control portamento On/Off.</p> <ul style="list-style-type: none"> ■ 64 - 127: Portamento On. ■ 0 - 63: Portamento Off. <p>When Mono/Poly is set to Mono and this parameter is On, you can effectively perform legato passages by playing successive notes smoothly with no breaks between notes (in other words, holding down one key and not releasing it until the next is played).</p> <p>The length (degree) of the portamento effect is controlled by Portamento Time (Control #5).</p>
Sostenuto (Control #66)	<p>Messages that control sostenuto On/Off.</p> <ul style="list-style-type: none"> ■ 64 - 127: Sostenuto On. ■ 0 - 63: Sostenuto Off. <p>Holding specific notes and then pressing and holding the sostenuto pedal will sustain those notes as you play subsequent notes, until the pedal is released.</p>

Harmonic Content (Control #71)	Messages that adjust the filter Resonance set for each part. The value set here is an offset value which will be added to or subtracted from the Part data.
Release Time (Control #72)	Messages that adjust the Amplitude EG Release Time set for each part. This is an offset that is added to or subtracted from the Part data.
Attack Time (Control #73)	Messages that adjust the Amplitude EG Attack Time set for each part. This is an offset that is added to or subtracted from the Part data.
Brightness (Control #74)	Messages that adjust the filter Cutoff Frequency set for each part. This is an offset that is added to or subtracted from the Part data.
Decay Time (Control #75)	Messages that adjust the Amplitude EG decay time set for each part. This is an offset that is added to or subtracted from the Part data.
Effect1 Depth (Reverb Send Level) (Control #91)	Messages that adjust the send level for the Reverb effect.
Effect3 Depth (Chorus Send Level) (Control #93)	Messages that adjust the send level for the Chorus effect.
Effect4 Depth (Variation Send Level) (Control #94)	Messages that adjust the send level for the Variation effect.
Data Increment (Control #96) and Data Decrement (Control #97)	Messages that increase or decrease the MSB value of pitch bend sensitivity, fine tune, or coarse tune in steps of 1. You will need to assign one of those parameters using the RPN in the external device in advance.
NRPN MSB (Control #99) and NRPN LSB (Control #98)	Used primarily as offset values for vibrato, filter, EG and other settings. Data Entry is used to set the parameter value after specifying the parameter using the NRPN (Non-Registered Parameter Number) MSB and LSB. Once an NRPN is specified, the following data entry message received on the same channel is processed as the value of that NRPN. You can prevent operational errors by transmitting an RPN Null message (7FH, 7FH) after using these messages to perform a control operation.
RPN MSB (Control #101) and RPN LSB (Control #100)	Used primarily as offset values for pitch bend sensitivity, tuning, and other part settings. First send the RPN (Registered Parameter Number) MSB and RPN LSB to specify the parameter which is to be controlled. Then use Data Increment/Decrement to set the value of the specified parameter. Once the RPN has been set for a channel, subsequent data entry will be recognized as the same RPN's value change. Therefore, after you use the RPN, you should set a Null (7FH, 7FH) value to avoid unexpected results. The RPN numbers that can be received are listed in Table 3: RPN Parameter List.



The NRPN MSB and NRPN LSB cannot be handled by the tone generator block in some synthesizers, although they can be recorded to a Song/Pattern track.

Table 3: RPN Parameter List

RPN		Parameter Name	Data Entry (Range)		Function
MSB	LSB		MSB	LSB	
000	000	Pitch Bend Sensitivity	0 - 24	-	Specifies the amount of pitch bend produced in response to pitch bend data in semitone increments.
000	001	Fine Tune	0 - 127	0 - 127	Adjusts the tuning in 100/8192 cent increments. The setting values are between -8192 and +8191 based on the formula "MSB x 128 + LSB."
000	002	Coarse Tune	-24 - +24	-	Adjusts the tuning in semitone increments.
127	127	Null	-	-	voids the RPN and NRPN settings so no tone generator settings are changed when subsequent Data Entry messages are received.

3-2-5 Channel Mode message

All Sounds Off (Control #120)	Clears all sounds currently sounding on the specified channel. However, the status of channel messages such as Hold1 or Sostenuato is maintained.
Reset All Controllers (Control #121)	Resets all controllers to their initial values. However, some controllers are not affected.
All Notes Off (Control #123)	Clears all notes currently on for the specified channel. However, if Hold1 or Sostenuato is on, notes will continue sounding until these are turned off.
Omni Mode Off (Control #124)	Performs the same operation as when an All Notes Off message is received. The receive channel is set to 1.
Omni Mode On (Control #125)	Performs the same operation as when an All Notes Off message is received. Only the receive channel is set to Omni On.
Mono (Control #126)	Performs the same operation as when an All Sound Off message is received. If the 3 rd byte parameter (the parameter that determines the mono number) is 0 - 16, the parts corresponding to those channels are set to Mono.
Poly (Control #127)	Performs the same function as when an All Sounds Off message is received. Sets the corresponding channel to Poly Mode.

3-2-6 Channel After Touch

Messages that let you control the sounds by the pressure you apply to the keys after the initial striking of the keys, over the entire channel.

3-2-7 Polyphonic After Touch

Messages that let you control the sounds by the pressure you apply to the keys after the initial striking of the keys, for each individual key.

3-3 System Messages

3-3-1 System Exclusive Messages

Changes internal tone generator settings such as Part and effect settings, remote switch control, tone generator mode switching, and others via MIDI.

The Device Number of the synthesizer must match the Device Number of the external MIDI device when transmitting/receiving bulk data, parameter changes or other System Exclusive Messages. System Exclusive Messages control various functions of this synthesizer, including master volume and master tuning, tone generator mode, effect type and various other parameters. Some System Exclusive Messages are called Universal Messages (for example, GM System On) and do not require a Device Number.

General MIDI (GM) System On	When this message is received, the synthesizer will receive MIDI messages that are compatible with GM System Level 1, and consequently will not receive Bank Select messages. When the instrument receives the GM System On message, each receive channel of parts 1 - 16 (in a Multi) will be assigned to 1 - 16. For best results, make sure that the interval between this message and the first note data of the song is a quarter note or longer. Data Format: F0 7E 7F 09 01 F7 (Hexadecimal).
MIDI Master Volume	When this message is received, the Volume MSB will be effective for the System Parameter. Data Format: F0 7F 7F 04 01 ll mm F7 (Hexadecimal), in which: <ul style="list-style-type: none"> ■ ll (LSB) = ignored; ■ mm (MSB) = appropriate volume value.

3-3-2 System Realtime Messages

System Common messages control the sequencer.

Start (FAH)	This message lets the MIDI sequence data start playing back from the beginning. This message will be transmitted when pressing the [▶] (Play) button at the top of the Song or Pattern.
Continue (FBH)	This message lets the MIDI sequence data start playing back from the current song position. This message will be transmitted when pressing the [▶] (Play) button at the middle of the Song or Pattern.
Stop (FCH)	This message causes MIDI sequence data (song) to stop playing back. This message will be transmitted when pressing the [■] (Stop) button during playback.
Active Sensing (FEH)	This is a type of MIDI message used to prevent unexpected results when a MIDI cable is disconnected or damaged while the instrument is being played. Once this message has been received, if no MIDI data is subsequently received within an interval period, the same function is performed as when All Sounds Off, All Notes Off, and Reset All Controllers messages are received, and the device returns to a status in which FEH is not monitored. The interval period is approximately 300 msec.
Timing Clock (F8H)	This message is transmitted with a fixed interval (24 times per 1/4 note) to synchronize connected MIDI instruments.

Yamaha Website (English only)
<http://www.yamahasyth.com>

Yamaha Downloads
<http://download.yamaha.com/>

Manual Development Group
©2011 Yamaha Corporation

Published 09/2018 MW-C0