



User Guide

Sound Bar

SR-C30A

EN

CONTENTS

INTRODUCTION 5

About this User Guide 5

Features 6

Confirming the included items 8

PART NAMES AND FUNCTIONS 10

Part names of the sound bar (front/top) 10

Part names of the sound bar (rear) 12

Part names of the subwoofer 13

Part names of the remote control 14

PREPARATION 16

Preparation 16

Precautions for preparation 18

Installing the product 20

Connecting a TV 22

Connecting a TV to the sound bar 22

Connecting a TV using only the included digital optical audio cable 24

Connecting a TV using an HDMI cable (commercially available) 26

Connecting an audio device 30

Preparing the remote control 34

Turning on and off the sound bar 35

PLAYBACK 36

Basic control during playback 36

Adjusting the sound to your preference	38
Sound functions of this product	38
Surround playback	40
Stereo playback	41
Adjusting the volume of the subwoofer	42
Playing back human voices clearly (CLEAR VOICE)	43
Enjoying rich bass sound (BASS EXT)	44
Listening to audio from a Bluetooth® device	45

ADDITIONAL FEATURES 48

Changing the brightness of the indicators (Dimmer)	48
Using a TV’s remote control to control the sound bar (HDMI Control)	49
Showing the type of audio signal and settings for functions	50
Controlling the sound bar with the smartphone app	51

CONFIGURATION 52

Enabling/disabling the HDMI Control function	52
Enabling/disabling the Auto Power Standby function	53
Enabling/disabling the Child Lock function	54
Enabling/disabling the Bluetooth Standby function	55
Enabling/disabling the Bluetooth function	56
Setting the dynamic range compression level	57
Setting the frequency characteristics of the sound according to how the sound bar is installed	59
Initializing the sound bar	61

TROUBLESHOOTING 62

Check the following first when any problem occurs	62
When a problem occurs: Power or overall functionality	63
When a problem occurs: Audio	71
When a problem occurs: Bluetooth®	76
When a problem occurs: App	78

Other actions 79

- How to connect AV devices such as BD/DVD players 79
- How to minimize standby power consumption 80
- Precautions for remote control batteries 81
- How to replace the remote control battery 82
- What to do if the sound bar and subwoofer are not paired automatically 83
- How to reset the sound bar 85

APPENDIX 86

Specifications 86

Supported digital audio signal formats 89

List of indicator displays 90

About third party software programs 94

List of support centers 95

INTRODUCTION

About this User Guide

- This User Guide uses the following signal words for important information:



WARNING

This content indicates “risk of serious injury or death.”



CAUTION

This content indicates “risk of injury.”

NOTICE

Indicates points that you must observe in order to prevent product failure, damage or malfunction and data loss, as well as to protect the environment.

NOTE

Indicates notes on instructions, restrictions on functions, and additional information that may be helpful.

- The illustrations and screens in this User Guide are for instructional purposes only.
- The company names and product names in this User Guide are the trademarks or registered trademarks of their respective companies.
- Various smartphones and tablet devices are collectively referred to as “mobile devices”. When necessary, the type of mobile device is specified in the explanations.
- A [Search tag] is a keyword for searching. This serves as a link from the Quick Start Guide to the User Guide.

NOTE

The Safety Brochure and the Quick Start Guide are included with this product. See the Safety Brochure first.

Features

This product is a bar-shaped speaker system for your TV that allows you to easily enjoy surround sound on the TV with a rich sense of presence.

■ Produce surround sound just by connecting to a TV



Related links

“Surround playback” (p.40)

■ Easily play audio content from a Bluetooth device



Related links

“Listening to audio from a Bluetooth® device” (p.45)

■ Configure the sound to match the situation

Clear Voice

This function focuses on the acoustic image of human voices such as dialog and narration within the audio and emphasizes the voices without changing the overall volume or individuality of the sound. Only the human voices become easier to hear, and it gives a clear sense of localization to the human voices.

- “Playing back human voices clearly (CLEAR VOICE)” (p.43)

Bass Extension

This function focuses on the acoustic image of the bass portion and enhances bass sound. It allows you to enjoy rich bass performance with a strong presence without disturbing the balance of the overall sound.

- “Enjoying rich bass sound (BASS EXT)” (p.44)

■ Multiple control methods to suit various usage situations

In addition to the sound bar’s controls and the included remote control, the TV’s remote control and the dedicated smartphone app “Sound Bar Remote” can also be used to control the sound bar.

Audio Return Channel (ARC) and HDMI Control function

An HDMI control function compatible TV allows for controlling the sound bar’s basic functions using the TV’s remote control. An Audio Return Channel (ARC) compatible TV can be connected to the sound bar using a single HDMI cable.

- “Using a TV’s remote control to control the sound bar (HDMI Control)” (p.49)
- “Connecting a TV using an HDMI cable (commercially available)” (p.26)

Dedicated smartphone app: “Sound Bar Remote”

The sound bar can also be controlled from your mobile device. The app allows you to check the current sound mode, sound settings, and volume level of the sound bar.

■ Certified as a Yamaha Eco-Product



Yamaha Eco-Label is a mark that certifies products of high environmental performance.

With an advanced energy saving design, this product achieves a low power consumption of 1.8 W or less when in standby mode.

Confirming the included items

The following items are included with this product. Make sure that all of the included items are present.

■ Main devices

- Sound bar (SR-CUC30A)



- Subwoofer (SR-WSWC30A)



■ Accessories

- Remote control

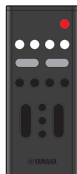

* A Lithium battery (CR2025) has already been inserted into the remote control.

- AC adaptor (model number: ANAD-420FIOT-B)

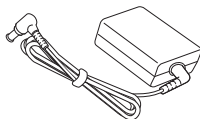

- Power cords (×2)



- Digital optical audio cable



INTRODUCTION > Confirming the included items

- Non-skid pads (×4 on 1 sheet)



* Attach these to the bottom of the subwoofer.

- Mounting template



* Use when mounting the sound bar on a wall.

- Spacers (A: ×2, B: ×2 on 1 sheet)



* Use when mounting the sound bar on a wall.

- Quick Start Guide



- Safety Brochure



PART NAMES AND FUNCTIONS

Part names of the sound bar (front/top)

This section describes the part names and functions of the front/top of the sound bar.

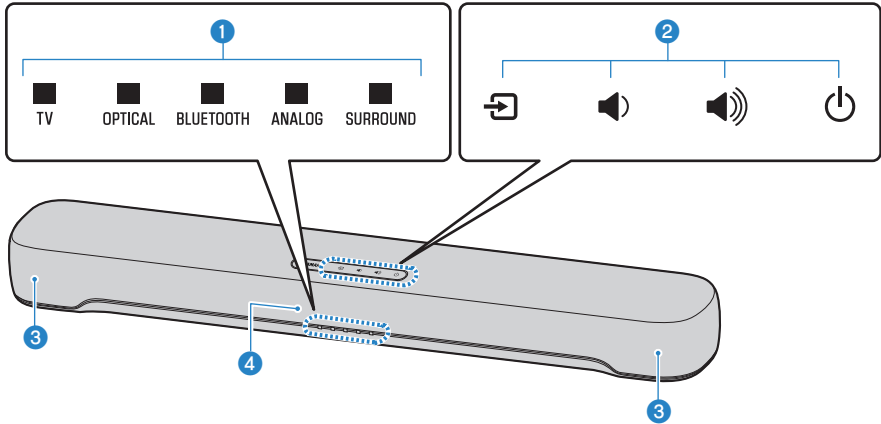

1 Indicators

The indicators flash or glow to show the operation and setting status. During normal playback, the setting status is indicated as follows:

TV, OPTICAL, BLUETOOTH, or ANALOG: Selected playback device

SURROUND: Surround playback (glowing) / Stereo playback (off)

NOTE

This document uses the following illustrations to show that indicators are off, glowing, or flashing.



Off



Glowing



Flashing

2 Controls

Touch the symbols with your fingertip to control the sound bar.

⏪ (Input): Select an input source (p.36).

🔊 / 🔊 (Volume +/-): Adjust the volume (p.36).

⏻ (Power): Turn the sound bar on and off.

3 Speakers

4 Remote control sensors

NOTE

- To prevent unintended operation, do not place anything on the controls of the sound bar.
Enabling the Child Lock function prevents accidental operation.
- The brightness of the indicators can be adjusted by pressing DIM.

Related links

- “Enabling/disabling the Child Lock function” (p.54)
- “Changing the brightness of the indicators (Dimmer)” (p.48)
- “List of indicator displays” (p.90)

Part names of the sound bar (rear)

This section describes the part names and functions of the rear of the sound bar.

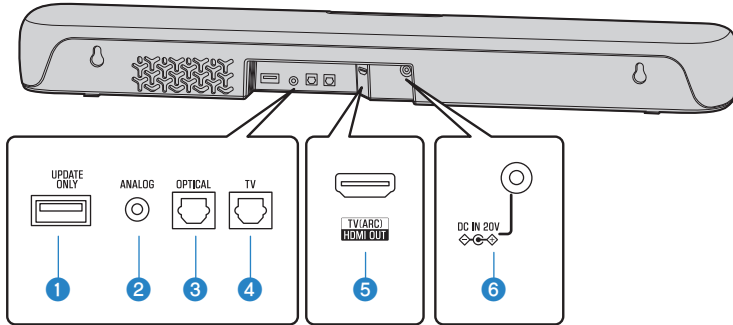

1 UPDATE ONLY jack

Use to update the sound bar's firmware.

Refer to the instructions supplied with the firmware for details.

2 ANALOG input jack (p.30)

3 OPTICAL input jack (p.30)

4 TV input jack (p.22)

5 HDMI OUT/TV (ARC) jack (p.26)

6 DC IN (20V) jack

Related links

- "Part names of the sound bar (front/top)" (p.10)
- "Part names of the remote control" (p.14)

Part names of the subwoofer

This section describes the part names and functions of the subwoofer.

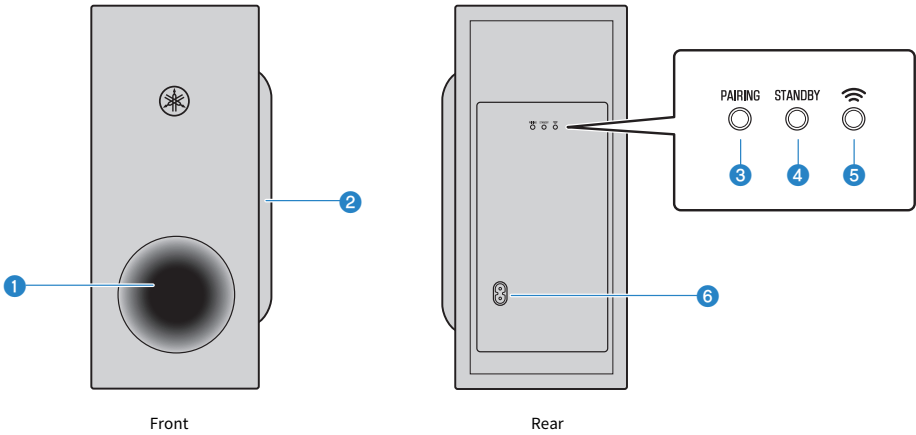

1 Bass reflex port

2 Speaker

3 PAIRING button

Use to pair the sound bar with the subwoofer manually. (p.83).

4 STANDBY indicator

Indicates the status of the subwoofer (p.72).

5  Indicator

Glowes when the subwoofer is connected to the sound bar (p.35).

6 AC power input connector

Use to connect the power cord of the subwoofer.

Related links

“List of indicator displays” (p.90)

Part names of the remote control

This section describes the part names and functions of the remote control.

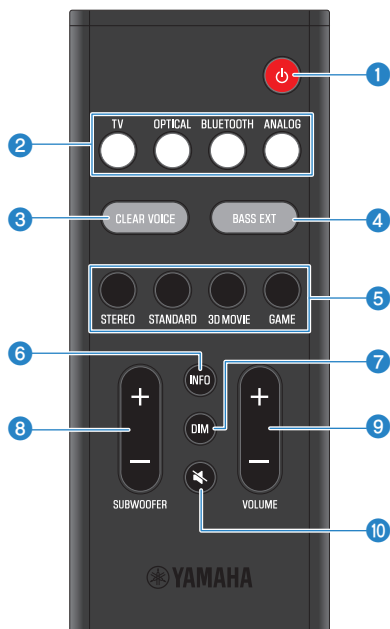

1  **(Power) button**

Turn the sound bar on and off (p.35).

2 **Input source buttons**

Select an audio input source (p.36).

- TV button: Audio from a TV
- OPTICAL button: Audio from a device connected to the OPTICAL input jack
- BLUETOOTH button: Audio from a Bluetooth device
- ANALOG button: Audio from a device connected to the ANALOG input jack

3 **CLEAR VOICE button**

Enable or disable the Clear Voice function (p.43).

4 **BASS EXT button**

Enable or disable the Bass Extension function (p.44).

5 Sound mode buttons

Switch to your preferred sound mode (p.38).

- STEREO
- STANDARD
- 3D MOVIE
- GAME

6 INFO button

Check information such as the type of audio signal being played and the settings for the sound bar's functions (p.50).

7 DIM button

Switch the brightness of the indicators of the sound bar (p.48).

8 SUBWOOFER (+/-) button

Adjust the volume of the subwoofer (p.42).

9 VOLUME (+/-) button

Adjust the volume of the sound bar (p.36).

10  (Mute) button

Mute the audio output (p.36). Press this button again, or press VOLUME (+/-) to unmute.

NOTE

Use the remote control within the range shown in the following illustration:

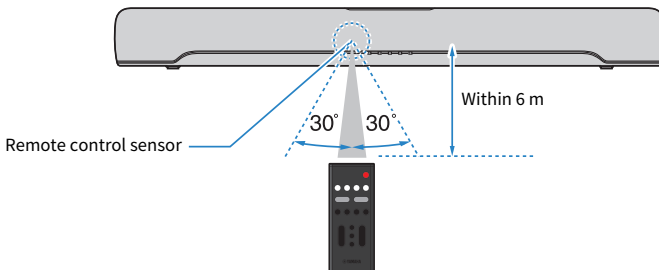

Related links

"Part names of the sound bar (front/top)" (p.10)

PREPARATION

Preparation

Install the sound bar and connect a TV to it.

1 Install the sound bar and subwoofer.

“Installing the product” (p.20)

2 Connect a TV to the sound bar.

Connect the TV to the sound bar using a method suitable for the type of jacks on the TV and the functions to be used.

“Connecting a TV using only the included digital optical audio cable” (p.24)

“Connecting a TV using an HDMI cable (commercially available)” (p.26)

3 Connect an audio device (if required).

“Connecting an audio device” (p.30)

4 Prepare the remote control.

“Preparing the remote control” (p.34)

5 Turn on the sound bar.

When the sound bar is turned on, the subwoofer turns on at the same time.

“Turning on and off the sound bar” (p.35)

NOTE

- Connect AV devices (such as BD/DVD players and set top boxes) to the TV's HDMI input jacks.

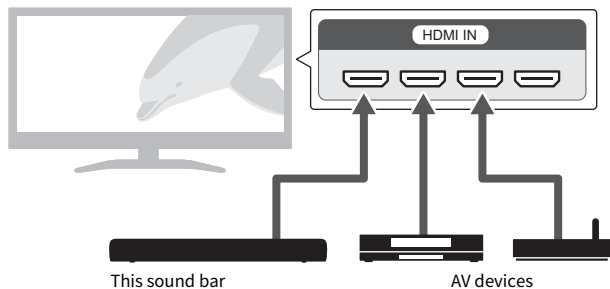

- When playing audio from a TV or AV device via the sound bar, set the input sources as follows:
 - Sound bar's input source: TV
 - TV's input source: AV device playing the content
- Audio Return Channel (ARC) is a function that transmits audio signals from the TV's HDMI input jack. This provides the same quality of audio as when connected with an digital optical audio cable.

Precautions for preparation

Before installing the sound bar and connecting other devices, be sure to read the following precautions. Be sure to follow the precautions.

■ Precautions for installation



WARNING

- Install as instructed in the User Guide. Failure to observe this may cause devices to fall and result in injury.
- Confirm that the finished installation is safe and secure. Also, carry out safety inspections periodically. Failure to observe this may cause devices to fall and result in injury.
- Do not expose the product to rain, use it near water or in damp or wet conditions, or place on the product any containers (such as vases, bottles or glasses) containing liquids which might spill into any openings or places where water may drop. A liquid such as water getting into the product may cause a fire, electric shocks, or malfunctions.
- Do not place any burning items or open flames near the product, since they may cause a fire.
- Do not use this product near medical devices or inside medical facilities. Radio waves from this product may affect electro-medical devices.



CAUTION

- Do not place the product in an unstable position where it might accidentally drop or fall over and cause injuries.
- When installing this product, do not obstruct heat dissipation. Failure to observe this may trap heat inside the product, causing a fire or malfunctions.
- Avoid being near the product during a disaster, such as an earthquake. Since the product may turn over or fall and cause injury, quickly move away from the product and go to a safe place.

NOTICE

- Do not install the product in places where it may come into contact with corrosive gases or salt air, or places that have excessive smoke or steam. Doing so may result in malfunction.
- Do not press hard on the speaker units or fabric-covered portion of this product.
- Do not place any objects susceptible to magnetism (such as a hard disk drive or magnetic card) near the product. The magnetic effect of the sound bar may cause damage to the object or its recorded data.
- Do not use this product in a location that becomes extremely hot, such as in direct sunlight or near a heater, or that becomes extremely cold, or that is subject to excessive dust or vibration. Failure to observe this may cause this product's panel to become deformed, the internal components to malfunction, or for operation to become unstable.
- If using a wireless function, avoid installing this product near metal walls or desks, microwave ovens, or other wireless network devices. Obstructions could shorten the transmission distance.
- Do not stack the sound bar and subwoofer directly on top of one another. Also, do not stack other AV devices directly on or under this product. These devices may malfunction due to vibrations.
- Do not place the subwoofer in the following ways. Doing so may cause a loss in bass sound volume.
 - With the speaker units (fabric-covered portion) placed tightly against the wall
 - With the bass reflex port blocked
- Do not place furniture or other objects made of metal between the sound bar and subwoofer. Doing so may interfere with the wireless connection.

■ Precautions for connections



WARNING

- Use this product with the power supply voltage printed on it. Failure to observe this may cause a fire, electric shocks, or malfunctions.
- Be sure to use the included power cord and AC adaptor. Do not use the included power cord and AC adaptor for other devices. Failure to observe this may cause a fire, electric shocks, or malfunctions.
- Never insert or remove an electric plug with wet hands. Do not handle this product with wet hands. Failure to observe this may cause electric shocks or malfunctions.
- Do not touch the power plug or cord if there is a chance of lightning. Failure to observe this may cause electric shocks.
- When setting up the product, make sure that the AC outlet you are using is easily accessible. If some trouble or malfunction occurs, immediately turn off the power switch and disconnect the plug from the AC outlet. Even when the power switch is turned off, as long as the power cord is not unplugged from the wall AC outlet, the product will not be disconnected from the power source.
- If not using the product for long periods of time, be sure to pull the power plug from the AC outlet. Failure to observe this may cause a fire or malfunctions.
- Check the electric plug periodically and remove any dirt or dust which may have accumulated on it. Failure to observe this may cause a fire or electric shocks.



CAUTION

- Do not use an AC outlet where the power plug fits loosely when inserted. Failure to observe this may cause a fire, electric shocks, or burns.
- When disconnecting the power plug, always hold the plug itself and not the cord. Pulling by the cord can damage it and cause electric shocks or a fire.
- Insert the power plug firmly all the way into the AC outlet. Using the product when it is not plugged in sufficiently can cause dust to accumulate on the plug, causing a fire or burns.

NOTICE

- If connecting external devices, be sure to thoroughly read the User Guide for each device and connect them in accordance with the instructions. Failure to properly handle a device in accordance with the instructions could cause malfunctions.
- Do not connect this product to industrial devices. This product has been designed to connect to consumer-use devices. Connection to an industrial-use device could cause this product to malfunction.

Installing the product

- Before installing the sound bar, be sure to read the following precautions.
 - “Precautions for preparation” (p.18)

Install the sound bar as shown in the following illustration.

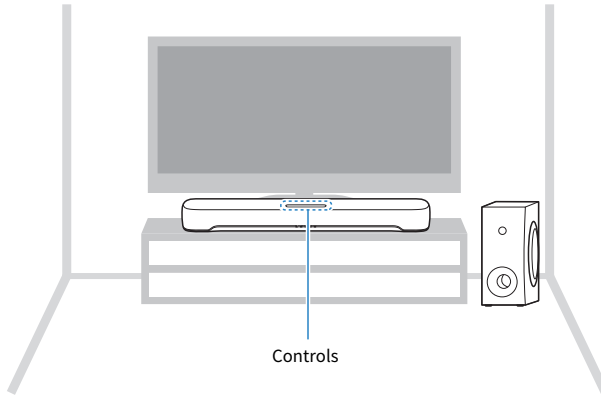

■ Installing the subwoofer

There are two ways to install the subwoofer: upright and on its side. Attach the non-skid pads to the bottom of the subwoofer according to how the subwoofer is installed.

Installing the subwoofer upright

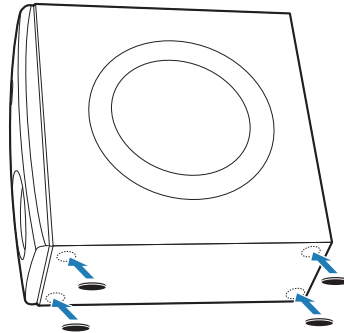

Installing the subwoofer on its side

[Search tag] # Q01 Subwoofer horizontal

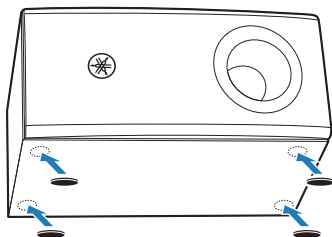

NOTICE

- When installing the subwoofer on a rack, ensure the following amount of space so as not to interfere with heat dissipation and bass output.

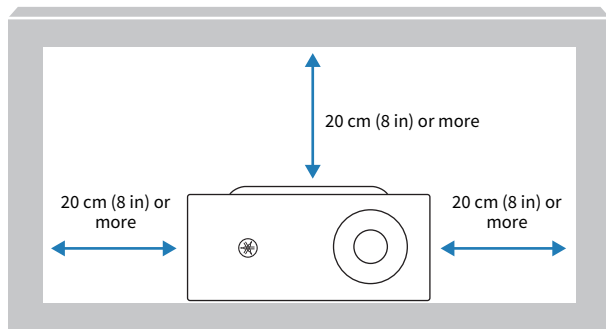

NOTE

- For proper installation of the sound bar on a wall, make sure to have it done by the dealer from which you purchased the unit or by a qualified contractor. Refer to the Wall Mounting Installation Guide for more information.
https://manual.yamaha.com/av/sb/wallmount/src20a_c30a/
- If you change how the sound bar is installed, switch the frequency characteristics. This will make the sound suitable for whichever way the sound bar is installed (p.59).

Related links

“Setting the frequency characteristics of the sound according to how the sound bar is installed” (p.59)

Connecting a TV

Connecting a TV to the sound bar

Select the connection procedure according to the type of jacks on the TV and the functions to be used.

■ Connecting a TV equipped with a digital optical audio output jack, and controlling the sound bar using the remote control included with this product

Connect the TV using the included digital optical audio cable.

Cable: Digital optical audio cable (included)

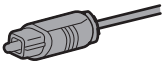

Jack of TV to connect to: Digital optical audio output jack



Connection procedure

“Connecting a TV using only the included digital optical audio cable” (p.24)

■ Controlling the sound bar using the TV’s remote control

Connect a TV using an HDMI cable. Prepare a commercially available HDMI cable compatible with Audio Return Channel (ARC). When connecting to an HDMI input jack not compatible with ARC, also connect the included digital optical audio cable.

Audio Return Channel (ARC) is a function that transmits audio signals from the TV’s HDMI input jack. An ARC-compatible HDMI input jack is labeled as “ARC.”

Cable: HDMI cable (commercially available) and, if needed, digital optical audio cable (included)

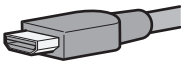

When connecting to an HDMI input jack not compatible with ARC



Jack of TV to connect to: HDMI input jack (compatible with ARC) and, if needed, digital optical audio output jack

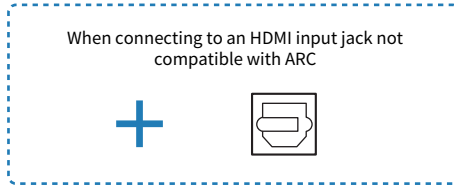

Connection procedure

“Connecting a TV using an HDMI cable (commercially available)” (p.26)

■ TV without a digital optical audio output jack, but equipped with an HDMI input jack compatible with Audio Return Channel (ARC)

Connect a TV using an HDMI cable. Prepare a commercially available HDMI cable compatible with ARC.

Cable: HDMI cable (commercially available)

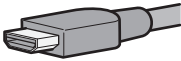

Jack of TV to connect to: HDMI input jack (compatible with ARC)



Connection procedure

“Connecting a TV using an HDMI cable (commercially available)” (p.26)

■ TV without a digital optical audio output jack and also without an HDMI input jack compatible with Audio Return Channel (ARC)

If the TV is equipped with an analog audio output jack or headphones jack, use one of these analog jacks to connect. Prepare a commercially available 3.5 mm stereo mini plug analog audio cable.

Cable: 3.5 mm stereo mini plug cable (commercially available)

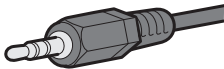

Jack of TV to connect to: Analog audio output jack or headphones jack

OUTPUT



Connection procedure

“Connecting an audio device” (p.30)

Connecting a TV using only the included digital optical audio cable

- Before connecting devices, be sure to read the following precautions.
 - "Precautions for preparation" (p.18)

Connect a TV using the included digital optical audio cable.

The TV's audio signal is transmitted to the sound bar.

1 Connect a TV to the sound bar.

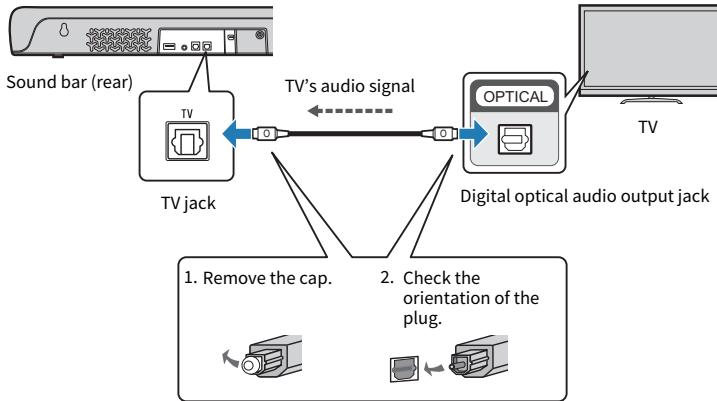

Cable to use



Digital optical audio cable (included)

2 Connect the sound bar and subwoofer to power.

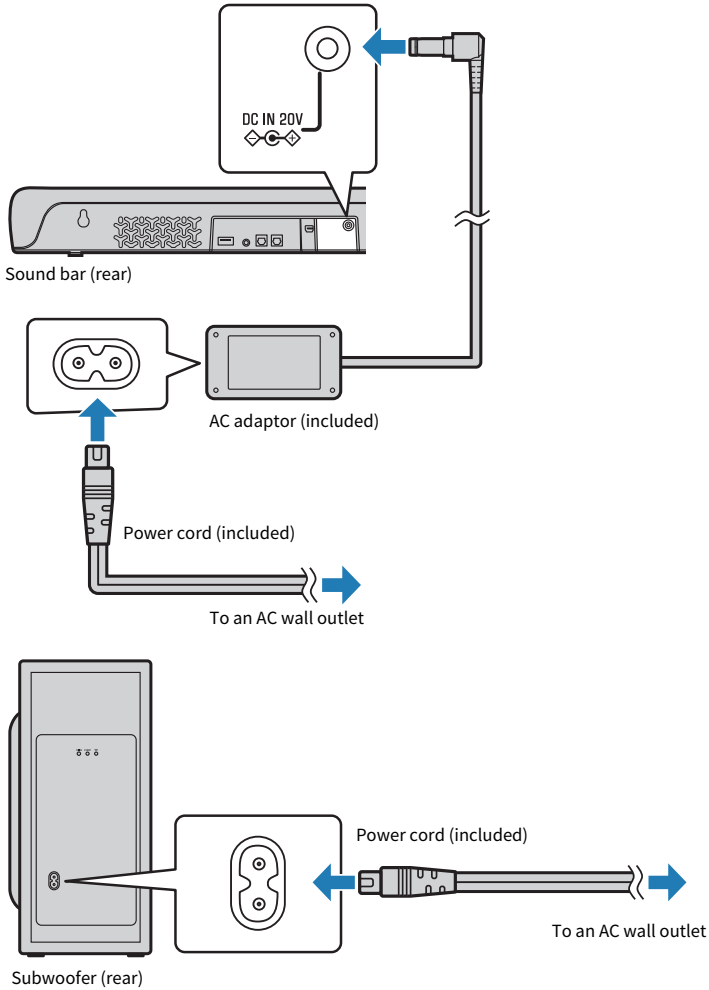

NOTE

Connect an AV device (such as a set top box) to the TV.

Connecting a TV using an HDMI cable (commercially available)

- Before connecting devices, be sure to read the following precautions.
 - “Precautions for preparation” (p.18)

If a TV is connected via an HDMI cable, the sound bar can be controlled by the HDMI Control function using the TV’s remote control.

■ Connecting to an HDMI input jack compatible with Audio Return Channel (ARC)

Connect the TV using an ARC-compatible HDMI cable (commercially available).

The HDMI cable transmits the TV’s audio signal and the control signal for controlling the sound bar using the TV’s remote control.

1 Connect a TV to the sound bar.

Connect an HDMI cable to the HDMI input jack compatible with Audio Return Channel (labeled as “ARC”) on the TV.

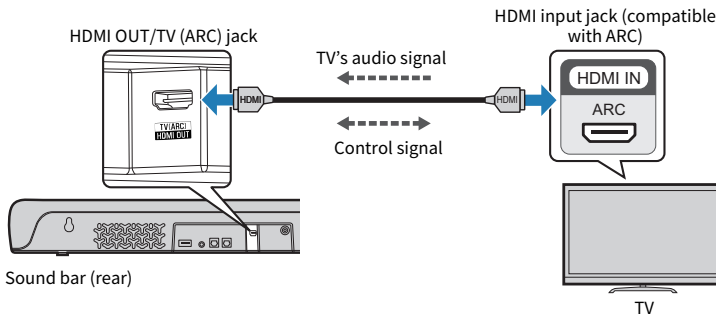

Cable to use



HDMI cable (commercially available)

2 Connect the sound bar and subwoofer to power.

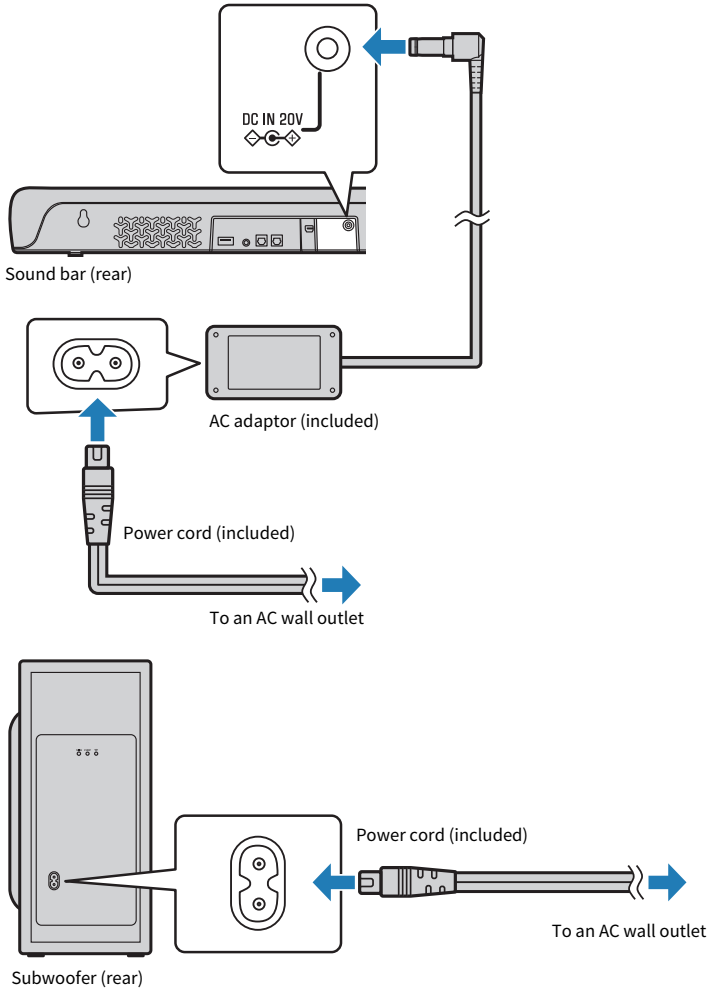

■ When connecting to an HDMI input jack not compatible with ARC

Connect the TV using an HDMI cable (commercially available) and included digital optical audio cable.

The digital optical audio cable transmits the TV's audio signal to the sound bar. The HDMI cable transmits the control signal for controlling the sound bar using the TV's remote control (HDMI Control function). If you do not want to use the HDMI Control function, you do not need to connect an HDMI cable.

1 Connect a TV to the sound bar.

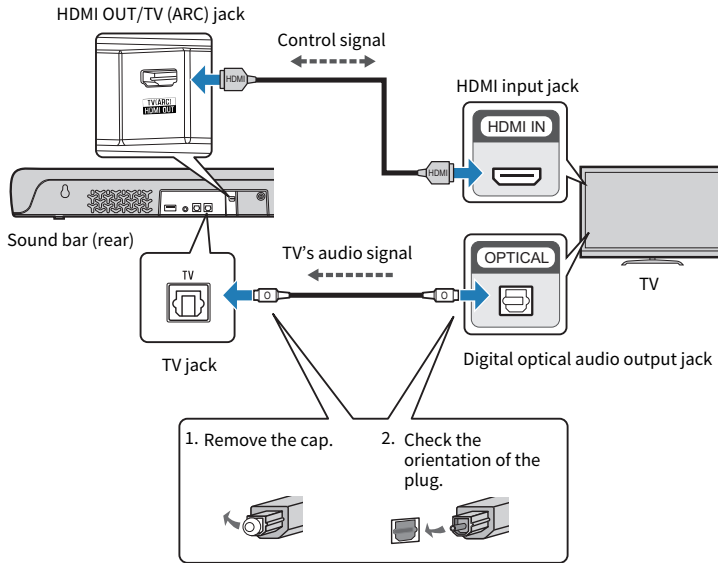

Cable to use

	Digital optical audio cable (included)
	HDMI cable (commercially available)

2 Connect the sound bar and subwoofer to power.

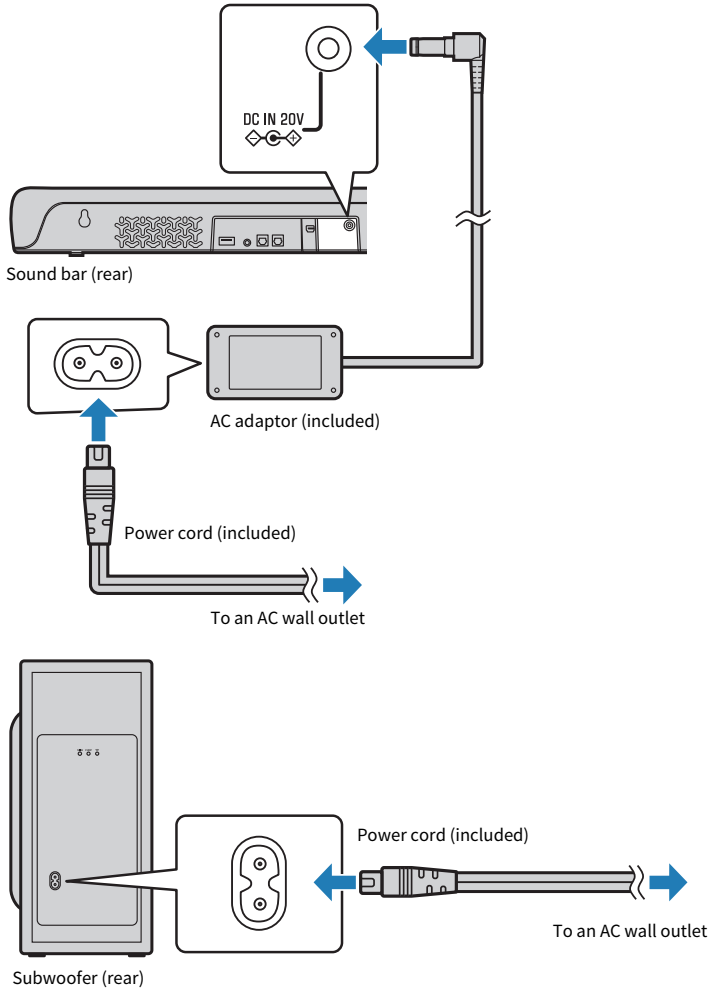

NOTE

- When connected to an ARC-compatible HDMI input jack, enable the HDMI Control function of the sound bar. Default setting: Enabled
- Use a 19-pin HDMI cable with the HDMI logo printed on it.
- Use a cable that is as short as possible to prevent any degradation in signal quality.
- Connect an AV device (such as a set top box) to the TV.

Related links

"Enabling/disabling the HDMI Control function" (p.52)

Connecting an audio device

- Before connecting devices, be sure to read the following precautions.
 - “Precautions for preparation” (p.18)

Devices equipped with audio output jacks can be connected directly to the sound bar.

■ A device with a digital optical audio output jack

Connect an audio device using a digital optical audio cable.

1 Connect an audio device to the sound bar.

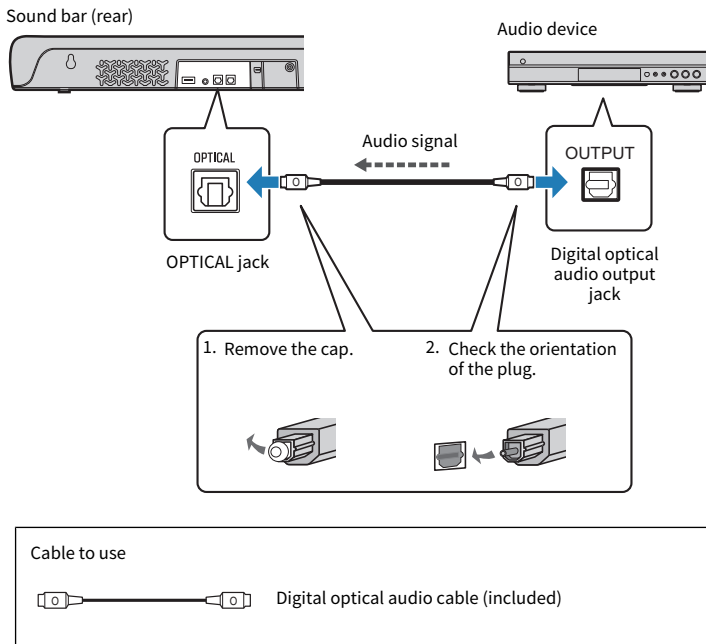

2 Connect the sound bar and subwoofer to power.

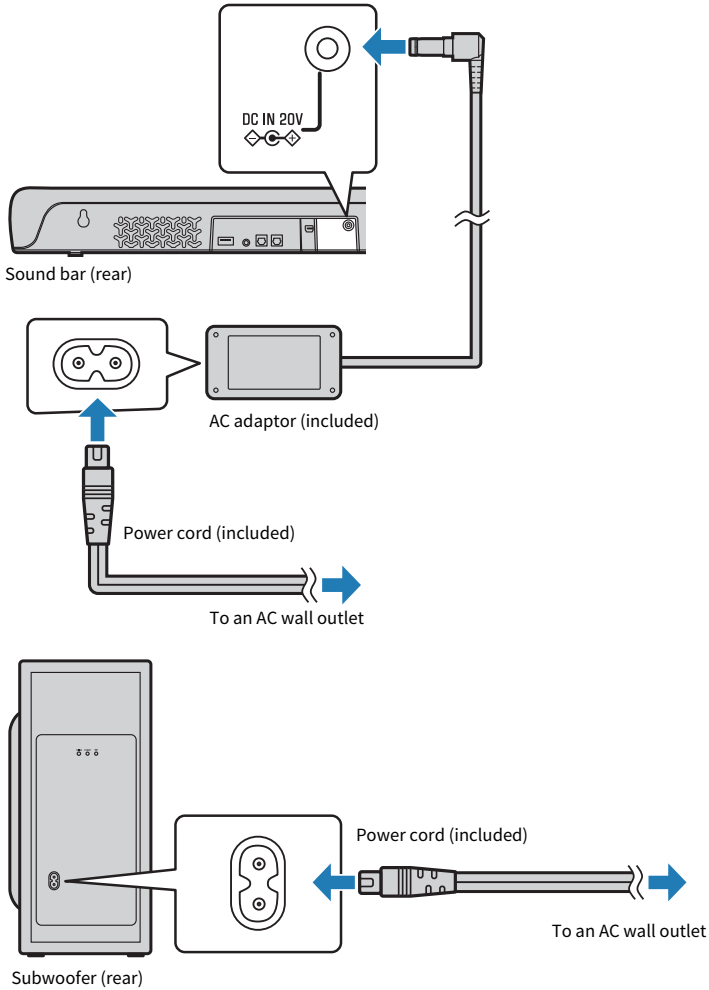

NOTE

When connecting a device equipped with video output, connect the video output jack directly to the video input jack on the TV.

■ A device with an analog audio output jack

Connect an audio device using a 3.5 mm stereo mini plug cable (commercially available).

1 Connect an audio device to the sound bar.

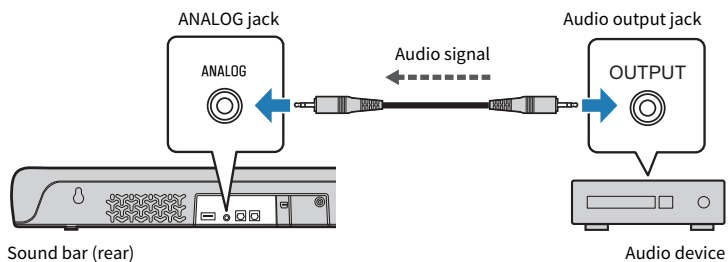

Cable to use



3.5 mm stereo mini plug cable (commercially available)

2 Connect the sound bar and subwoofer to power.

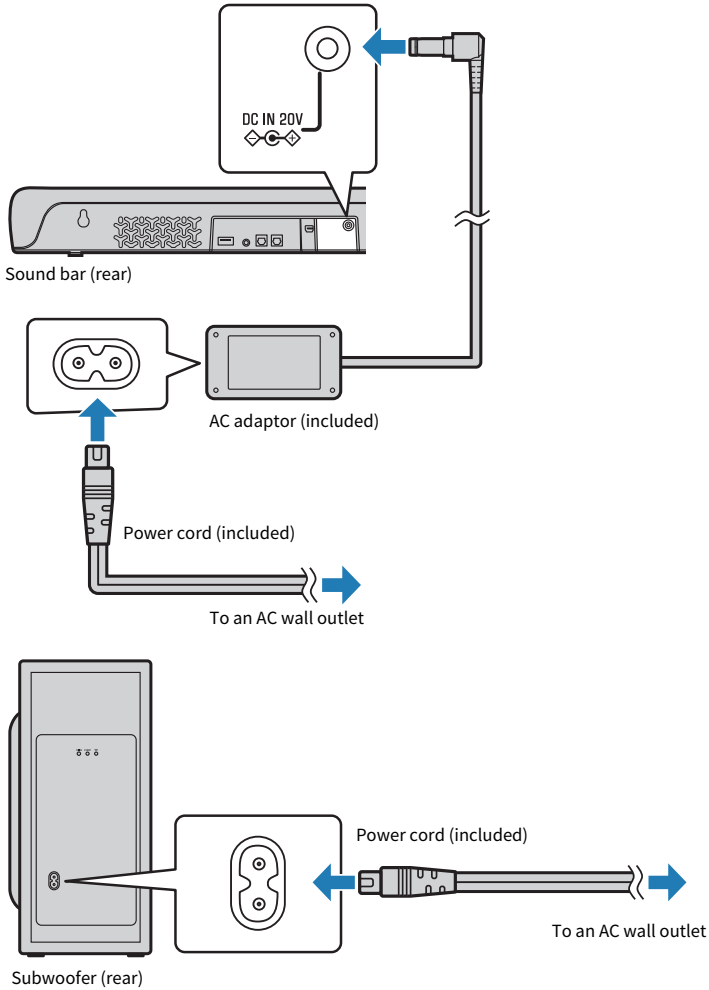

CAUTION

- If the volume can be adjusted on a device connected to the ANALOG input jack of the sound bar, adjust the volume of the device so that the volume is about the same for both the TV and the device.

NOTE

When connecting a device equipped with video output, connect the video output jack directly to the video input jack on the TV.

Preparing the remote control

Remove the battery insulating strip before attempting to use the remote control.

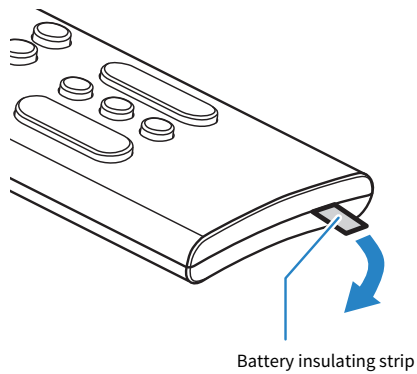

Related links

["How to replace the remote control battery" \(p.82\)](#)

Turning on and off the sound bar

Turn the sound bar on and off.

1 Press (power) button.

Pressing the button turns the sound bar on and off.

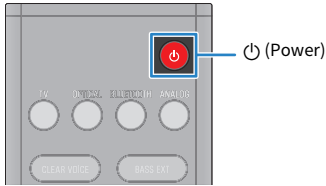



When the sound bar is turned on, all the indicators glow, and then some indicators remain glowing to show the setting status (normal display).



When the sound bar is turned off, the indicators go off.

NOTE

- The same operation can also be performed from the sound bar's  (power) button.
- When the sound bar is turned on, the sound bar and subwoofer are automatically connected wirelessly. When the connection is established, the  indicator on the rear of the subwoofer glows.



PLAYBACK

Basic control during playback

This section describes the basic control operations available during playback.

■ Selecting an input source

Press one of the following buttons.

- TV button: Audio from a TV
- OPTICAL button: Audio from a device connected to the OPTICAL input jack
- BLUETOOTH button: Audio from a Bluetooth device
- ANALOG button: Audio from a device connected to the ANALOG input jack

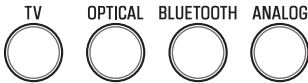

The indicator of the selected input source button glows.

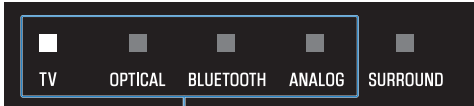

One of the indicators glows

■ Adjusting volume

Press VOLUME (+/-) to adjust the volume.



The number of glowing indicators changes to show the volume level.



Volume is turned up (+)

Volume is turned down (-)

PLAYBACK > Basic control during playback

If audio is being output from both the TV speakers and the sound bar, mute the TV.

To temporarily mute the sound bar, press . To unmute, press  again or press VOLUME (+/-).





While muted, the indicators will show the following.



Flashing

NOTE

The same operations can also be performed from the sound bar's controls.

-  (Input): For selecting a device to play.
-  /  (Volume +/-): For adjusting the volume.

Related links

- “Surround playback” (p.40)
- “Stereo playback” (p.41)
- “Playing back human voices clearly (CLEAR VOICE)” (p.43)
- “Enjoying rich bass sound (BASS EXT)” (p.44)
- “Listening to audio from a Bluetooth® device” (p.45)

Adjusting the sound to your preference

Sound functions of this product

This product is equipped with sound modes for surround playback and for stereo playback. There are also various sound settings for adjusting the sound to suit your preferences even better.

■ Sound modes

A sound mode can be selected from among three sound modes for surround playback and one sound mode for stereo playback.

STEREO

This sound mode provides stereo playback. This sound mode is best suited for music playback.

STANDARD

This sound mode provides surround playback that is best suited for TV programs such as sports broadcasts. It emphasizes the acoustic image of human voices and makes the voices easier to hear, while reproducing a wide sound field.

3D MOVIE

This sound mode provides surround playback that is best suited for movies. It reproduces a three-dimensional sound field and creates a sound space that seems to envelop your body.

GAME

This sound mode provides surround playback that is best suited for video games. It accurately reproduces and emphasizes the localization of individual sound effects for a highly immersive gaming experience.

■ Sound settings

The sound settings allow you to adjust the sound to better suit your preferences.

Clear Voice

The human voices within the audio can be heard more easily without turning up volume when the Clear Voice function is enabled. The function is recommended for enjoying movies or dramas at a low volume, and for movies or dramas that use a lot of background music and sound effects.

Bass Extension

The acoustic image of bass sound is enhanced when the Bass Extension function is enabled. It allows you to enjoy rich bass performance with a strong presence without disturbing the balance of the overall sound.

Related links

- “Surround playback” (p.40)
- “Stereo playback” (p.41)
- “Playing back human voices clearly (CLEAR VOICE)” (p.43)
- “Enjoying rich bass sound (BASS EXT)” (p.44)

Surround playback

Press STANDARD, 3D MOVIE, or GAME to switch to surround playback. Select your preferred sound mode according to the content viewed or listened to.

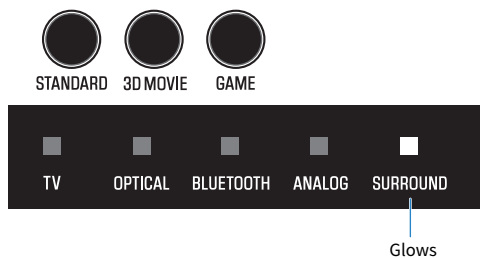

Related links

[“Sound functions of this product” \(p.38\)](#)

Stereo playback

Press STEREO to switch to 2-channel stereo playback.



Off

Related links

[“Sound functions of this product” \(p.38\)](#)

Adjusting the volume of the subwoofer

Adjust the volume of the subwoofer only.

Press SUBWOOFER (+/-) to adjust the volume.



SUBWOOFER

The glowing indicator changes to show the volume level.



Volume is turned down (-)

Volume is turned up (+)

Playing back human voices clearly (CLEAR VOICE)

The human voices within the audio can be heard more easily without turning up volume when the Clear Voice function is enabled. The function is recommended for enjoying movies or dramas at a low volume, and for movies or dramas that use a lot of background music and sound effects.

Press CLEAR VOICE to enable or disable the function.

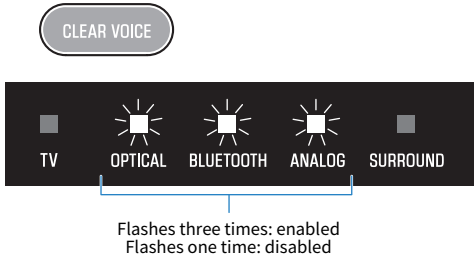

NOTE

- Press INFO to see whether the Clear Voice function is enabled or disabled.
- Clear Voice is a function that focuses on and emphasizes the acoustic image of human voices within the audio. Only the human voices are emphasized without changing the overall volume and frequency characteristics, and it gives a clear sense of localization to the human voices.

Related links

“Showing the type of audio signal and settings for functions” (p.50)

Enjoying rich bass sound (BASS EXT)

The acoustic image of bass sound is enhanced when the Bass Extension function is enabled. It allows you to enjoy rich bass performance with a strong presence without disturbing the balance of the overall sound. This function is recommended when you want to increase the bass while suppressing the volume of the subwoofer, or when you want to emphasize the sounds of low-pitched instruments.

Press BASS EXT to enable or disable the function.

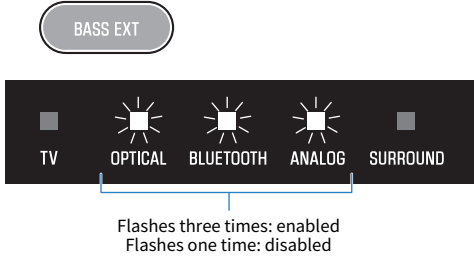

NOTE

Press INFO to see whether the Bass Extension function is enabled or disabled.

Related links

"Showing the type of audio signal and settings for functions" (p.50)

Listening to audio from a Bluetooth® device

Audio content from a Bluetooth device can be played through the sound bar.

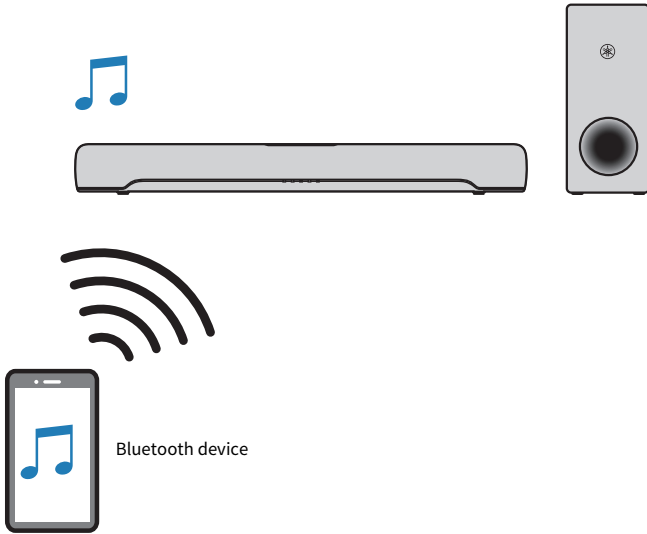

1 Press **BLUETOOTH** to switch the input source to Bluetooth.



The sound bar enters the connection wait status, and the **BLUETOOTH** indicator flashes.

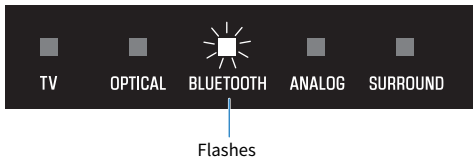

2 On the **Bluetooth device**, enable the **Bluetooth** function.

3 Select the sound bar on the Bluetooth device.

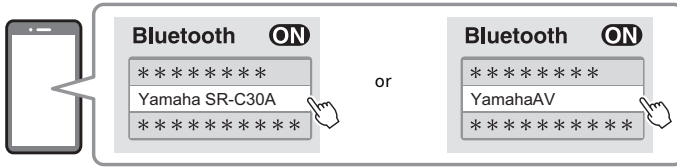

When the connection is established, the BLUETOOTH indicator on the sound bar stops flashing and starts glowing blue.

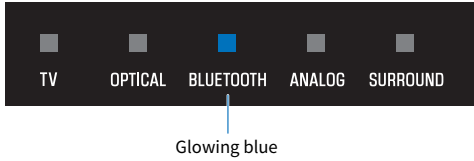

4 Start playback on the Bluetooth device.

The sound bar will begin playing audio from the Bluetooth device.

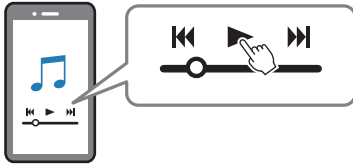

NOTE

- “Compressed Music Enhancer” is enabled during playback from a Bluetooth device to reproduce the rich, deep sound that the audio had prior to compression.
- Enabling the Bluetooth standby function allows the sound bar to be turned on automatically when a connection operation is performed with a Bluetooth device.
- If other Bluetooth devices have been connected before, the sound bar will connect to the last connected device when the input source is switched to Bluetooth.
- The Bluetooth connection is terminated if one of the following operations is performed.
 - The Bluetooth function of the Bluetooth device is turned off.
 - BLUETOOTH on the sound bar’s remote control is held down for at least five seconds.
 - An input source other than Bluetooth is selected on the sound bar.
 - Turn off the sound bar.
- Adjust the volume level of the Bluetooth device if necessary.
- Perform Bluetooth device operations within 10 m (33 ft) of the sound bar.

Related links

“Enabling/disabling the Bluetooth Standby function” (p.55)

■ Switching Bluetooth devices for playback (multipoint connection)

The sound bar can be connected to two Bluetooth devices simultaneously. It is easy to switch between the Bluetooth devices for playback.

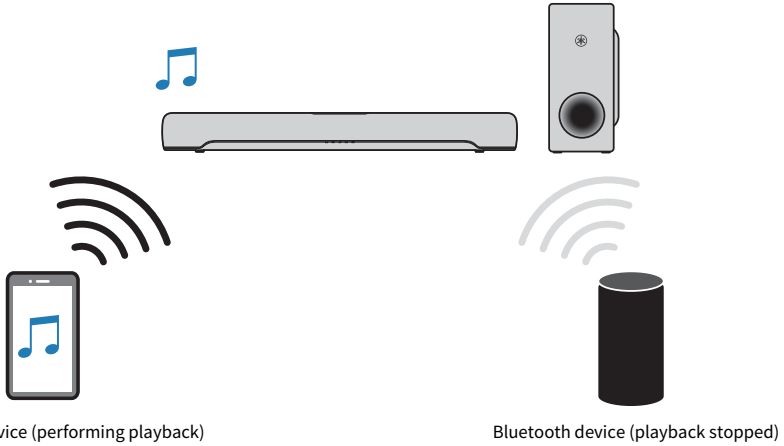

Perform the following procedures to switch between devices for playback.

- 1 Stop playback on the Bluetooth device.**
- 2 Start playback on the other Bluetooth device.**

Audio from the other Bluetooth device can be heard on the sound bar.

NOTE

When connecting a new Bluetooth device, disconnect the currently connected Bluetooth device and then connect the new device.

ADDITIONAL FEATURES

Changing the brightness of the indicators (Dimmer)

Change the brightness of the indicators of the sound bar to one of three levels: “Bright”, “Dim”, or “Off”. The brightness is “Dim” by default.

1 Turn on the sound bar.

2 Press DIM.



Press the button to change the brightness in the order of “Dim”, “Off” and “Bright”.

NOTE

Indicators glow brightly just after operation and then change to the specified brightness after a few seconds.

Using a TV's remote control to control the sound bar (HDMI Control)

When the sound bar is connected to a TV via an HDMI cable, the sound bar can be controlled using the TV's remote control. This is called the HDMI Control function.

TV's remote control (example)

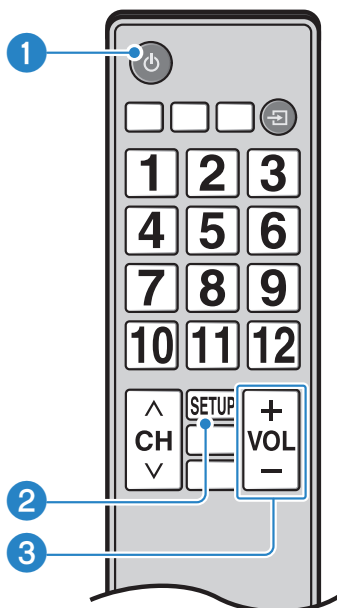

1 Turn the power on and off

Both the TV and the sound bar turn on/off at the same time.

2 Switch the audio output device

The audio output device can be switched to the TV or the sound bar. Control operations vary depending on the TV's type.

3 Adjust volume

The sound bar's volume can be adjusted when the TV's audio output is set to the sound bar.

Related links

["Enabling/disabling the HDMI Control function" \(p.52\)](#)

Showing the type of audio signal and settings for functions

The type of audio signal being played and settings for the sound bar's functions can be checked.

1 Press INFO.



The indicators on the sound bar will show the following information on the type of audio signal and the settings for functions for three seconds immediately after INFO is pressed.

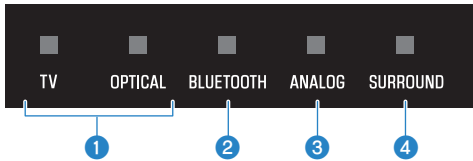

1 Type of audio signal

TV glows white: Dolby Digital

OPTICAL glows white: AAC

TV and OPTICAL off: PCM, analog, or no input signal

2 Whether Dolby Pro Logic II is enabled or disabled

Glows: enabled

Off: disabled

NOTE

Dolby Pro Logic II is enabled automatically when 2-channel stereo signals are played in surround.

3 Whether the Bass Extension function is enabled or disabled

Glows: enabled

Off: disabled

4 Whether the Clear Voice function is enabled or disabled

Glows: enabled

Off: disabled

Controlling the sound bar with the smartphone app

By installing the free dedicated app “Sound Bar Remote” on a smartphone, the sound bar can also be controlled from that smartphone.

Search for “Sound Bar Remote” on the App Store or Google Play and install it on the mobile device.



After installing the app on your smartphone, connect to the sound bar via Bluetooth and open the app. The app allows you to control the sound bar while checking its current settings via the following simple screen.

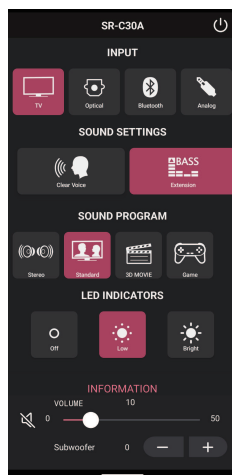

For details on the app, see the description of the app on the App Store or Google Play.

NOTE

- This sound bar supports Sound Bar Remote only. This sound bar cannot be controlled using other apps (such as Sound Bar Controller).
- To control the sound bar using the app, configure the settings on the mobile device as follows:
 - Enable the Bluetooth function.
 - For devices using the Android 11 OS or earlier, configure the settings to allow location information to be obtained. The Sound Bar Remote app uses location information from the Android device only to detect the sound bar. The acquired location information will not be used for any other purpose.
 - For devices using the Android 12 OS or later, configure the settings to allow the use of nearby devices.

CONFIGURATION

Enabling/disabling the HDMI Control function

Enabling the HDMI Control function allows the sound bar to be controlled using the TV's remote control.

Default setting: Enabled

- 1 Turn off the sound bar.**
- 2 Hold down TV for at least five seconds.**



The HDMI Control function switches from enabled to disabled, or from disabled to enabled.

The indicator shows the setting status as follows, and the sound bar is turned on.

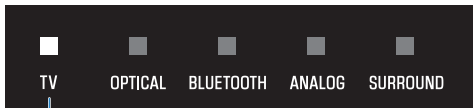

Glow: enabled
Off: disabled

NOTE

When connected to a TV's ARC-compatible HDMI input jack, enable the HDMI Control function.

Related links

- "Connecting a TV using an HDMI cable (commercially available)" (p.26)
- "The sound bar cannot be controlled using the TV's remote control" (p.70)

Enabling/disabling the Auto Power Standby function

Enabling the Auto Power Standby function turns off the sound bar in any of the following situations.

- No control operations for eight hours
- No audio input and no control operations for 20 minutes (except when ANALOG is selected as the input source)

The default setting varies depending on the model.

Models for U.S.A., Canada, Mexico, Australia, China and Taiwan: Disabled

Models for Europe, U.K., Korea, and other areas: Enabled

1 Turn off the sound bar.

2 While holding down on the sound bar, hold down for at least five seconds.



The Auto Power Standby function switches from enabled to disabled, or from disabled to enabled.

The indicator shows the setting applied as follows, and the sound bar is turned on.



Glow: disabled
Off: enabled

Enabling/disabling the Child Lock function

Locking the controls of the sound bar prevents accidental operation (Child Lock function).

Default setting: Disabled (no Child Lock)

- 1 Turn off the sound bar.**
- 2 Hold down INFO for at least five seconds.**



The Child Lock function switches from enabled to disabled, or from disabled to enabled.

The indicator shows the setting applied as follows, and the sound bar is turned on.



Glow: enabled (Child Lock)
Off: disabled (no Child Lock)

Enabling/disabling the Bluetooth Standby function

Enabling the Bluetooth Standby function allows the sound bar to be turned on automatically when a Bluetooth device connects to the sound bar.

Default setting: Enabled

- 1 Turn off the sound bar.**
- 2 Hold down BLUETOOTH for at least five seconds.**



The Bluetooth Standby function switches from enabled to disabled, or from disabled to enabled.

The indicator shows the setting applied as follows, and the sound bar is turned on.



Glows: enabled
Off: disabled

Enabling/disabling the Bluetooth function

The Bluetooth function can be disabled.

Default setting: Enabled

- 1 Turn off the sound bar.**
- 2 Hold down DIM for at least five seconds.**



The Bluetooth function switches from enabled to disabled, or from disabled to enabled.

The indicator shows the setting applied as follows, and the sound bar is turned on.



Glows: enabled
Off: disabled



Setting the dynamic range compression level

Compressing the dynamic range of audio signals (the volume difference between the loudest and quietest sounds) makes it easier to listen at a low volume. This setting is applied only when Dolby Digital audio signals are being played.

Default setting: No compression



1 Turn off the sound bar.

2 Hold down one of the following buttons for at least five seconds.

Compression level	Function	Button of remote control
Maximum compression	Apply the maximum amount of dynamic range compression.	 STANDARD
Standard compression	Apply an amount of dynamic range compression well suited for a typical room.	 3D MOVIE
No compression	Dynamic range compression is not applied.	 GAME

The dynamic range compression level setting is changed.

The indicator shows the setting status as follows, and the sound bar is turned on.

Compression level	Sound bar's indicators
Maximum compression	 <p>TV OPTICAL BLUETOOTH ANALOG SURROUND</p> <p>Glowing red</p>
Standard compression	 <p>TV OPTICAL BLUETOOTH ANALOG SURROUND</p> <p>Glowing white</p>
No compression	 <p>TV OPTICAL BLUETOOTH ANALOG SURROUND</p> <p>Glowing white</p>

CONFIGURATION > Setting the frequency characteristics of the sound according to how the sound bar is installed

Setting the frequency characteristics of the sound according to how the sound bar is installed

Switch the frequency characteristics of the sound bar so that the sound suits the way it is installed.

Default setting: Installed on a stand

Wall-mounted

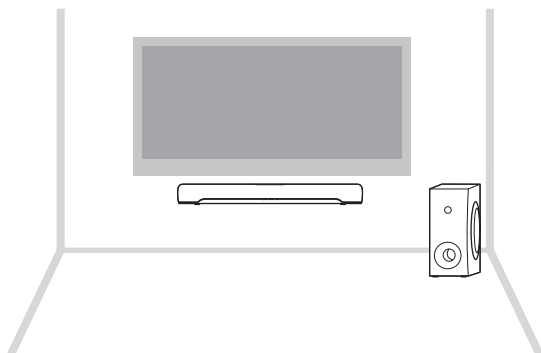

Installed on a stand

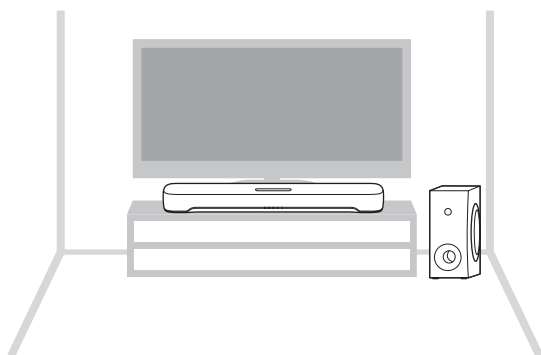

- 1 Turn off the sound bar.**

CONFIGURATION > Setting the frequency characteristics of the sound according to how the sound bar is installed

2 According to how the sound bar is installed, hold down one of the following buttons for at least five seconds.

- Wall-mounted



- Installed on a stand



The frequency characteristics setting is changed.

The indicator shows the setting status as follows, and the sound bar is turned on.

Wall-mounted

Sound bar's indicators

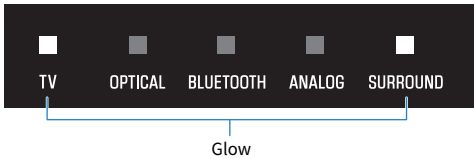

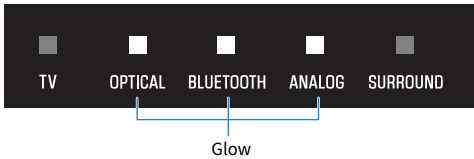

Installed on a stand

Sound bar's indicators



Initializing the sound bar

Reset the settings of the sound bar to the factory presets.

- 1 The sound bar is turned off.**
- 2 While holding down  on the sound bar, hold down  until all indicators flash.**



Initialization is performed. When initialization is complete, the indicators will show the following.



Flash (initialization complete)

TROUBLESHOOTING

Check the following first when any problem occurs

Make sure of the following when the product does not function properly.

- The power cords of all the devices are connected to AC wall outlets securely.
- The product, TV and AV devices are turned on.
- The connectors of each cable are securely inserted into the jacks on each device.

Related links

“List of support centers” (p.95)

When a problem occurs: Power or overall functionality

The power turns off suddenly

● **The Auto Power Standby function turned off the sound bar.**

Enabling the Auto Power Standby function turns off the sound bar automatically in any of the following situations.

- No control operations for eight hours
- No audio input and no control operations for 20 minutes (except when ANALOG is selected as the input source)

Turn on the sound bar again. The Auto Power Standby function can be disabled.

- “Enabling/disabling the Auto Power Standby function” (p.53)

● **The protection circuitry has been activated. (The TV indicator on the sound bar flashes red.)**

After confirming that all connections are made properly, turn on the sound bar again. If the power still turns off frequently, unplug the power cord from the AC wall outlet and contact the nearest authorized Yamaha dealer or service center.

- “List of support centers” (p.95)

The power cannot be turned on

● **The protection circuitry has been activated three times consecutively.**

To protect the product, the power cannot be turned on. Unplug the power cord from the AC wall outlet and contact the nearest authorized Yamaha dealer or service center.

- “List of support centers” (p.95)

No operations can be performed from the sound bar's controls

● **The controls of the sound bar are locked.**

Unlock the controls of the sound bar.

- “Enabling/disabling the Child Lock function” (p.54)

All indicators are off although the power is on (the power appears to be off)

● **Indicator brightness is set to “Off”.**

Change the brightness.

- “Changing the brightness of the indicators (Dimmer)” (p.48)

The sound bar does not function correctly

- **The internal microcomputer is frozen due to an external electric shock (such as lightning or excessive static electricity) or to a drop in the power supply voltage.**
 - Unplug the power cords of the sound bar and subwoofer from the AC wall outlets, and then plug them in again after at least 10 seconds.

The sound bar turns on by itself

● **Another Bluetooth device is being operated nearby.**

Terminate the Bluetooth connection with the sound bar.

- “Listening to audio from a Bluetooth® device” (p.45)

The sound bar cannot be controlled with the remote control

● **The sound bar is out of the operating range.**

Use the remote control within the operating range.

- “Part names of the remote control” (p.14)

● **The battery has run out.**

Replace the battery with a new one.

- “How to replace the remote control battery” (p.82)

● **The remote control sensor of the sound bar is exposed to direct sunlight or strong lighting.**

Adjust the lighting angle or reposition the sound bar.

The sound bar cannot be controlled using the TV's remote control

● The HDMI Control function is not properly configured.

Confirm that the settings are properly configured as follows:

- The HDMI Control function of the sound bar is enabled.
- The HDMI Control function is enabled on the TV.
- In the TV's HDMI settings, the audio output destination is set to an option other than the TV's built-in speakers.

If the sound bar still cannot be controlled with the TV's remote control, perform the following:

- Turn off the sound bar and the TV, and then turn them back on again.
- Unplug the power cord of the sound bar, as well as the power cords of external devices connected to the sound bar via an HDMI cable, from the AC wall outlet. Plug them in again after about 30 seconds.

Related links

["Enabling/disabling the HDMI Control function" \(p.52\)](#)

● The TV does not support the sound bar's control functions.

Even if your TV supports the HDMI Control function, some functions may not be available. For details, see the documentation supplied with your TV.

When a problem occurs: Audio

No sound

● **The input source you are attempting to play back from is not selected.**

Select the correct input source.

- “Basic control during playback” (p.36)

● **The mute function is active.**

Cancel the mute function.

- “Basic control during playback” (p.36)

● **The volume is too low.**

Turn up the volume.

- “Basic control during playback” (p.36)

● **The power cord of the sound bar is not connected securely.**

Make sure that the power cord of the sound bar is properly connected to an AC wall outlet.

● **An input jack is connected to another input jack.**

Connect the input jack on the sound bar to the output jack on the AV device.

● **A signal that the sound bar cannot play is being input.**

Change the digital audio output setting on the TV or AV device to a type of audio signal supported by the sound bar.

- “Supported digital audio signal formats” (p.89)

● **The HDMI Control function is disabled.**

When connecting a TV that supports ARC (Audio Return Channel) to the sound bar using an HDMI cable only, enable the HDMI Control function.

To output audio from the sound bar when the HDMI Control function is disabled, connect the TV's digital optical audio output jack to the sound bar's TV jack (digital optical) via a digital optical audio cable.

- “Enabling/disabling the HDMI Control function” (p.52)
- “Connecting a TV using an HDMI cable (commercially available)” (p.26)

● **The audio output destination of a TV using HDMI Control is the TV's built-in speakers.**

In the TV's HDMI settings, set the audio output destination to an option other than the TV's built-in speakers.

No sound is coming from the subwoofer

● **The playback source does not contain subwoofer channel signals or low-frequency signals.**

Try to play content containing subwoofer channel signals, to see if any sound can be heard from the subwoofer.

● **The volume of the subwoofer is too low.**

Turn up the volume of the subwoofer.

- “Adjusting the volume of the subwoofer” (p.42)

● **The power cord of the subwoofer is not connected to an AC wall outlet.**

Connect the power cord of the subwoofer to an AC wall outlet.

● **The protection circuitry has been activated. (Both the STANDBY indicator and  indicator on the subwoofer are flashing.)**

To protect the product, the power of the subwoofer cannot be turned on. Unplug the power cord from the AC wall outlet and contact the nearest authorized Yamaha dealer or service center.

● **The  indicator on the subwoofer is flashing.**

The condition of the wireless connection is bad, and the subwoofer cannot be connected to the sound bar. Try the following.

- Place the subwoofer closer to the sound bar.
- If metal furniture is placed between the sound bar and subwoofer, change the layout or relocate the subwoofer.
- If a device emitting electromagnetic waves (such as a microwave oven or a wireless LAN device) is located nearby, place the subwoofer and sound bar farther away from it.

● **The subwoofer is waiting for pairing with the sound bar. (The STANDBY indicator on the subwoofer is flashing.)**

If the sound from the subwoofer could be heard until now without any problem:

The PAIRING button on the subwoofer was accidentally pressed, and the subwoofer has been in the pairing state.

Unplug the power cord of the subwoofer from the AC wall outlet, and then plug it in again after at least five seconds. Then, turn on the sound bar and it will function properly.

If this problem occurs after performing a pairing operation:

Pairing failed.

Unplug the power cord of the subwoofer from the AC wall outlet, and then plug it in again after at least five seconds. Check that the sound bar and subwoofer are installed properly, and try pairing the sound bar and subwoofer manually.

- “What to do if the sound bar and subwoofer are not paired automatically” (p.83)

The volume decreases when the sound bar is turned on

● **The Automatic Volume Adjustment function lowered the volume.**

To prevent unexpected excessive loudness, the sound bar is equipped with the Automatic Volume Adjustment function. If the sound bar was turned off with the volume set high, the volume is automatically adjusted to a safe listening level the next time the sound bar is turned on. Turn up the volume if necessary.

- “Basic control during playback” (p.36)

No surround effect

● **Stereo playback is selected.**

Select surround playback.

- “Surround playback” (p.40)

● **The volume is too low.**

Turn up the volume.

- “Basic control during playback” (p.36)

● **The TV or AV device is set to output 2-channel audio (such as PCM) only.**

Change the audio output setting on the TV or AV device to output Bitstream audio signals.

● **Sound is also heard from the TV’s built-in speakers.**

Turn the TV’s volume all the way down.

● **You are listening from a position that’s extremely close to the sound bar.**

You should listen at some distance from the sound bar.

Noise is heard

- **The sound bar is too close to another digital or high-frequency device.**

Move those devices away from the sound bar.

When a problem occurs: Bluetooth®

The sound bar cannot be connected to a Bluetooth® device

● **Bluetooth is not selected as the input source of the sound bar.**

Select Bluetooth as the input source.

- “Listening to audio from a Bluetooth® device” (p.45)

● **The sound bar is too far away from the Bluetooth device.**

Move the Bluetooth device closer to the sound bar.

● **A device emitting electromagnetic waves (such as a microwave oven or a wireless device) is located nearby.**

Do not use the sound bar near devices that emit electromagnetic waves.

● **The Bluetooth device you are using does not support the A2DP profile.**

Use a Bluetooth device that supports the A2DP profile.

● **The connection profile registered in the Bluetooth device is not functioning correctly.**

Delete the connection profile in the Bluetooth device, and then connect the Bluetooth device to the sound bar.

● **The passkey for devices such as a Bluetooth adaptor is not “0000”.**

Use a Bluetooth device with a passkey of “0000”.

● **The sound bar is already connected to another Bluetooth device (when connecting a Bluetooth device for the first time).**

Terminate the current Bluetooth connection, and then connect to the new device.

● **The sound bar is already connected to two Bluetooth devices (when these devices have been connected to the sound bar before).**

Disconnect one of the currently connected Bluetooth devices, and then connect to another device.

● **The Bluetooth function of the sound bar is disabled.**

Enable the Bluetooth function.

- “Enabling/disabling the Bluetooth function” (p.56)

No sound can be heard or the sound cuts off intermittently from a Bluetooth® device

- **The volume on the Bluetooth device is too low.**

Raise the volume on the Bluetooth device.
- **Bluetooth is not selected as the input source of the sound bar.**

Select Bluetooth as the input source.

 - “Listening to audio from a Bluetooth® device” (p.45)
- **Playback is not being performed on the Bluetooth device.**

Perform playback on the Bluetooth device.
- **The audio output destination on the Bluetooth device is not set to the sound bar.**

Select the sound bar as the audio output destination on the Bluetooth device.
- **The connection to the Bluetooth device was terminated.**

Connect to the Bluetooth device again.
- **The sound bar is too far away from the Bluetooth device.**

Move the Bluetooth device near the sound bar.
- **A device emitting electromagnetic waves (such as a microwave oven or a wireless device) is located nearby.**

Do not use the sound bar near devices that emit electromagnetic waves.
- **Playback is being performed on another Bluetooth device.**

Stop the current playback, and perform playback on the other Bluetooth device.

When a problem occurs: App

The app cannot detect the sound bar

● **An app not supported by the sound bar is being used.**

This sound bar supports Sound Bar Remote only. Sound Bar Controller, Home Theater Controller, and MusicCast Controller cannot be used.

● **The Bluetooth function on the mobile device is disabled.**

Enable the Bluetooth function on the mobile device.

● **On an Android device, the function for obtaining location information is disabled.**

The Sound Bar Remote app uses the location information of the Android device only to detect the sound bar. According to your Android device OS, change the settings as follows:

- For devices using the Android 11 OS or earlier, configure the settings to allow location information to be obtained.
- For devices using the Android 12 OS or later, configure the settings to allow the use of nearby devices.

Other actions

How to connect AV devices such as BD/DVD players

Connect AV devices, such as BD/DVD players and set top boxes, to the TV's HDMI input jacks.

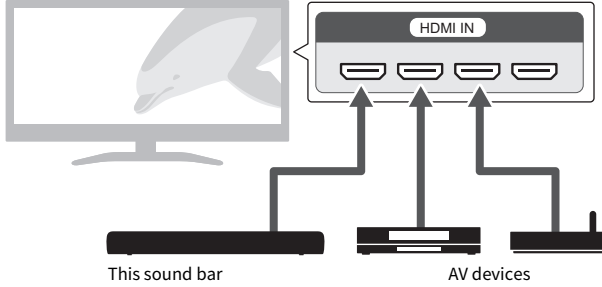

When playing audio from a TV or AV device via the sound bar, set the input sources as follows:

- Sound bar's input source: TV
- TV's input source: AV device playing the content

How to minimize standby power consumption

Change the settings as follows:

- HDMI Control: Disabled
- Bluetooth Standby: Disabled

Related links

- “Enabling/disabling the HDMI Control function” (p.52)
- “Enabling/disabling the Bluetooth Standby function” (p.55)

Precautions for remote control batteries

Before replacing the remote control battery with a new one, be sure to read the following precautions. Be sure to follow the precautions.



WARNING

- The remote control included with this product contains a coin/button cell battery. Do not ingest the coin/button battery. Keep new and used batteries away from children. If the battery compartment does not close securely, keep it away from children. If the coin/button cell battery is swallowed, it can cause severe chemical burns and dissolve tissues inside the body in less than 2 hours, and can lead to death. If you think batteries might have been swallowed or placed inside any part of the body, seek immediate medical attention.
- Do not dispose of a battery in fire. Do not expose a battery to high temperatures, such as direct sunlight or a fire. Do not attempt to charge the battery installed in the included remote control. The battery could burst or leak, causing a fire or injury.
- Do not disassemble a battery. If the battery leaks, avoid contact with the leaked fluid. If the contents of the battery get on your hands or in your eyes, it can cause blindness or chemical burns. If the battery fluid should come in contact with your eyes, mouth, or skin, wash immediately with water and consult a doctor.



CAUTION

- Do not use a battery other than the specified one. Doing so may cause fire or burns, or result in fluid leakage that may cause skin inflammation.
- Always make sure the battery is inserted in conformity with the +/- polarity markings. Failure to do so might result in a fire, burns, or inflammation due to fluid leaks.
- When the battery runs out, or if the sound bar is not to be used for a long time, remove the battery from the remote control to prevent possible leakage of the battery fluid.
- Do not put in a pocket or bag, carry, or store batteries together with pieces of metal. The battery could short, burst, or leak, causing a fire or injury.
- When storing or discarding batteries, insulate the terminal area by applying tape, or some other protection. Mixing them with other batteries or metal objects can cause a fire, burns, or inflammation due to fluid.

How to replace the remote control battery

- Before replacing the battery with a new one, be sure to read the following precautions.
 - “Precautions for remote control batteries” (p.81)

When the battery runs out, the sound bar can no longer be controlled with the remote control. Replace the battery with a new one.

1 Slide the cover in the direction of the arrow to remove it.

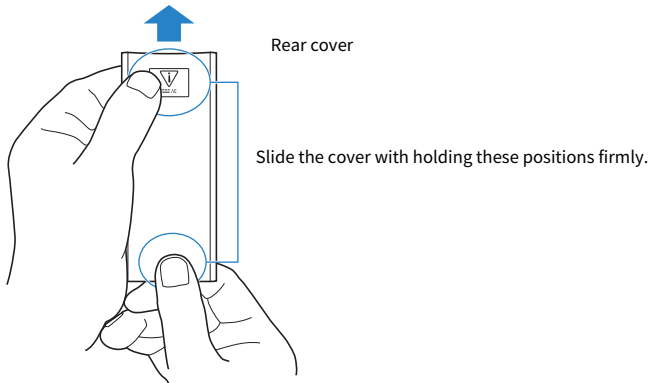

2 Remove the old battery and insert a new one.

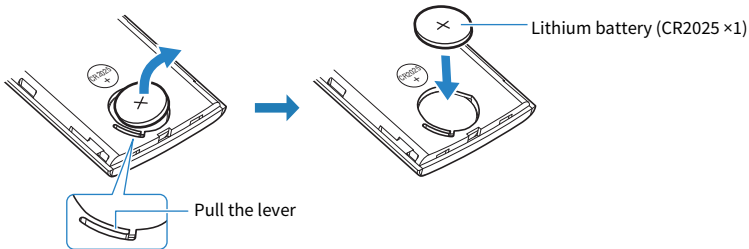

3 Slide the cover back into its position in the direction of the arrow.

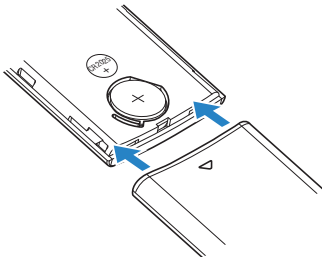

What to do if the sound bar and subwoofer are not paired automatically

Normally, the sound bar and subwoofer are paired automatically, but if they are not properly paired due to a temporary communications failure, pair them manually.

NOTE

Pairing is the process of having the sound bar and subwoofer recognize one another as devices to connect to.

- 1 Turn off the sound bar.**
- 2 Press and hold SUBWOOFER (-) on the remote control for at least five seconds.**

The sound bar is turned on, and the OPTICAL indicator on the sound bar flashes.

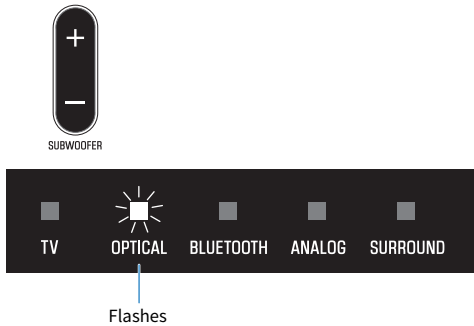

- 3 Within 30 seconds, press and hold PAIRING on the rear of the subwoofer for at least five seconds.**

When the sound bar and subwoofer have been paired successfully, the  indicator glows.

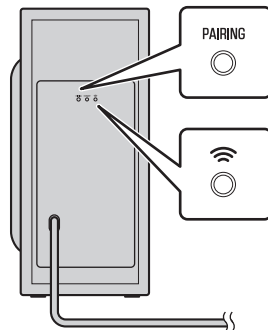

If the  indicator on the subwoofer does not glow after following the procedure above, do the following and then perform pairing manually again.

- Move the subwoofer and/or the sound bar so that they are closer to each other.

TROUBLESHOOTING > Other actions

- Install the sound bar and subwoofer in positions where they are not obstructed from each other by metal furniture.
- If a device emitting electromagnetic waves (such as a microwave oven or a wireless LAN device) is located nearby, place the subwoofer and sound bar farther away from it.

How to reset the sound bar

Reset the sound bar by performing the following operations.

■ To restart the sound bar

Unplug the power cords of the sound bar and subwoofer from the AC wall outlets, and then plug them in again after at least 10 seconds and turn on the power.

■ To initialize the sound bar

Refer to the following explanation and reset the settings of the sound bar to the factory presets.

“Initializing the sound bar” (p.61)

APPENDIX

Specifications

The specifications of this product are as follows.

■ Sound bar

Amplifier section

Maximum rated output power

- Front L/R 20 W × 2 channels

Speaker section

Front L/R

- Type Acoustic suspension type
(non-magnetic shielding)
- Driver 4.6 cm (1-13/16") cone × 2
- Frequency response 210 Hz to 22 kHz
- Impedance 6 Ω

Decoder

Supported audio signal
(HDMI (ARC)/optical input)

PCM (up to 2 channels)
Dolby Digital (up to 5.1 channels)

Input jacks

Digital optical 2 (TV, OPTICAL)

Analog (3.5 mm stereo mini) 1 (ANALOG)

Output jacks

HDMI 1 (HDMI OUT/TV (ARC))

Other jacks

USB 1 (UPDATE ONLY)

Bluetooth

Function	Sink function (source device to this unit)
Bluetooth version	Ver 5.0
Supported profiles	A2DP
Supported codecs	Sink function: SBC, AAC
Bluetooth class	Bluetooth Class 1
Range (line-of-sight)	Approx. 10 m (33 ft)
Supported content protection method	SCMS-T (sink function)
Models for U.K. and Europe	
<ul style="list-style-type: none"> • Radio frequency 	2402 MHz to 2480 MHz
<ul style="list-style-type: none"> • Maximum output power (EIRP) 	7.8 dBm (6.0 mW)

General

Power supply	
<ul style="list-style-type: none"> • Models for U.S.A., Canada, Taiwan and Mexico 	AC 100 to 120 V, 50/60 Hz
<ul style="list-style-type: none"> • Models for U.K., Europe, and other areas 	AC 100 to 240 V, 50/60 Hz
Power consumption (AC adaptor output voltage/current)	20 V/2.1 A
Standby power consumption	
<ul style="list-style-type: none"> • [Models for U.S.A., Canada, Taiwan and Mexico] <ul style="list-style-type: none"> • HDMI Control/Bluetooth Standby: Off • HDMI Control/Bluetooth Standby: On 	0.3 W 0.5 W
<ul style="list-style-type: none"> • [Models for U.K., Europe, and other areas] <ul style="list-style-type: none"> • HDMI Control/Bluetooth Standby: Off • HDMI Control/Bluetooth Standby: On 	0.3 W 0.5 W
Dimensions (W x H x D)	
<ul style="list-style-type: none"> • Installing the Sound Bar in front of a TV, etc. 	600 × 64 × 94 mm (23-5/8" × 2-1/2" × 3-3/4")
<ul style="list-style-type: none"> • Mounting the Sound Bar on a wall, with spacers 	600 × 64 × 102 mm (23-5/8" × 2-1/2" × 4")
Weight	1.3 kg (2.9 lb)

NOTE

The contents of this User Guide apply to the latest specifications as of the publishing date. The latest version of the User Guide is available to download from the Yamaha website.

■ Subwoofer

Amplifier section

Maximum rated output power	50 W
----------------------------	------

Speaker section

• Type	Bass reflex (non-magnetic shielding)
• Driver	13 cm (5-1/8") cone × 1
• Frequency response	40 Hz to 210 Hz
• Impedance	3 Ω

Wireless function (Wireless communication between the sound bar and subwoofer)

• Radio frequency band	2.4 GHz
• Transmission range	Approx. 10 m ([33 ft] without interference)

Models for U.K. and Europe

• Radio frequency	2405.35 MHz to 2477.35 MHz
• Maximum output power (EIRP)	9.0 dBm (7.9 mW)

General

Power supply

• Models for U.S.A., Canada, Taiwan and Mexico	AC 100 to 120 V, 50/60 Hz
• Models for U.K., Europe, and other areas	AC 100 to 240 V, 50/60 Hz

Power consumption	20 W (Rated)
-------------------	--------------

Standby power consumption	0.8 W
---------------------------	-------

Dimensions (W x H x D)

• Installing the subwoofer upright, with non-skid pads	160 × 337 × 364 mm (6-1/4" × 13-1/4" × 14-3/8")
• Installing the subwoofer horizontal, with non-skid pads	335 × 162 × 364 mm (13-1/4" × 6-3/8" × 14-3/8")

Weight	5.7 kg (12.6 lb)
--------	------------------

NOTE

The contents of this User Guide apply to the latest specifications as of the publishing date. The latest version of the User Guide is available to download from the Yamaha website.

Supported digital audio signal formats

The following digital audio signals are supported by this product.

TV, OPTICAL, and TV (ARC)

Audio formats	Details
2-channel Linear PCM	2 channels, 32 / 44.1 / 48 / 88.2 / 96 kHz, up to 24-bit
Bitstream	Dolby Digital

NOTE

The contents of this User Guide apply to the latest specifications as of the publishing date. The latest version of the User Guide is available to download from the Yamaha website.

List of indicator displays

The indicators of this product display information primarily in the following ways:

■ Sound bar's indicators

NOTE

This document shows indicator glowing status as follows:



Off



Glowing



Flashing

Power off state



Normal playback state

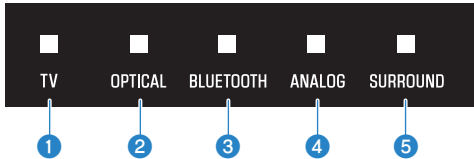

1 TV

Glowing: Playing audio from the TV

2 OPTICAL

Glowing: Playing audio from the OPTICAL input jack

3 BLUETOOTH

Glowing blue: Bluetooth device connection established
Flashing white: Bluetooth device connection wait status

4 ANALOG

Glowing: Playing audio from the ANALOG input jack

5 SURROUND

Glowing white: Surround playback

Off: Stereo playback

Showing the type of audio signal and settings for functions

The indicators on the sound bar will show the following information on the type of audio signal and the settings for functions for three seconds immediately after INFO is pressed.

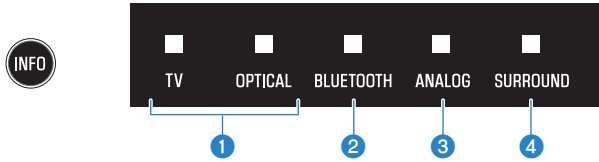

1 Type of audio signal

TV glows white: Dolby Digital

OPTICAL glows white: AAC

TV and OPTICAL off: PCM, analog, or no input signal

2 Whether Dolby Pro Logic II is enabled or disabled

Glow: enabled

Off: disabled

NOTE

Dolby Pro Logic II is enabled automatically when 2-channel stereo signals are played in surround.

3 Whether the Bass Extension function is enabled or disabled

Glow: enabled

Off: disabled

4 Whether the Clear Voice function is enabled or disabled

Glow: enabled

Off: disabled

Muted state



An error occurred



Flashes red

NOTE

- When the brightness of the indicators is set to “Off”, the indicators glow only during control operations.
- See the description of each setting for what the indicators will show when the setting is changed.

Related links

- “Basic control during playback” (p.36)
- “Showing the type of audio signal and settings for functions” (p.50)
- “Changing the brightness of the indicators (Dimmer)” (p.48)
- “When a problem occurs: Power or overall functionality” (p.63)

Information displayed by the indicators of the subwoofer

NOTE

This document shows indicator glowing status as follows:



Off



Glowing



Flashing

Power on state



Power off state



Establishing a connection to the sound bar



Waiting for pairing with the sound bar



An error occurred and the protection circuitry has been activated



Trademarks



Dolby, Dolby Audio, Pro Logic, and the double-D symbol are trademarks of Dolby Laboratories Licensing Corporation. Manufactured under license from Dolby Laboratories. Confidential unpublished works. Copyright © 2012–2021 Dolby Laboratories. All rights reserved.



HIGH-DEFINITION MULTIMEDIA INTERFACE

The terms HDMI and HDMI High-Definition Multimedia Interface, and the HDMI Logo are trademarks or registered trademarks of HDMI Licensing Administrator, Inc. in the United States and other countries.



The Bluetooth® word mark and logos are registered trademarks owned by Bluetooth SIG, Inc. and any use of such marks by Yamaha Corporation is under license. Other trademarks and trade names are those of their respective owners.

About third party software programs

This sound bar uses third party software programs.

For the copyright and the license agreement terms and conditions of third party software programs that are used, see the following website.

<https://manual.yamaha.com/av/cm/sla/22/src30a/>

List of support centers

If the trouble still cannot be solved, please contact us for product support as shown below.

For customers within Japan

- Please contact the store where you purchased this product, or the Product Support Center as listed in the “Safety Brochure” included with this product.

For customers outside of Japan

- Please contact your nearest authorized Yamaha dealer or service center.
<https://manual.yamaha.com/av/support/>

Yamaha Global Site
<https://www.yamaha.com/>

Yamaha Downloads
<https://download.yamaha.com/>

© 2022 Yamaha Corporation

Published 05/2022 NV-A0

AV21-0115