



AVANT GRAND

NU1X

Owner's Manual
Mode d'emploi
Manual de instrucciones

Before using this instrument, be sure to read "PRECAUTIONS" on pages 5-6.

Avant d'utiliser cet instrument, lisez attentivement la section « PRÉCAUTIONS D'USAGE » aux pages 5-6.

Antes de utilizar el instrumento, lea la sección "PRECAUCIONES", en las páginas 5-6.

ENGLISH

FRANÇAIS

ESPAÑOL

EN

FR

ES

SPECIAL MESSAGE SECTION

PRODUCT SAFETY MARKINGS: Yamaha electronic products may have either labels similar to the graphics shown below or molded/stamped facsimiles of these graphics on the enclosure. The explanation of these graphics appears on this page. Please observe all cautions indicated on this page and those indicated in the safety instruction section.

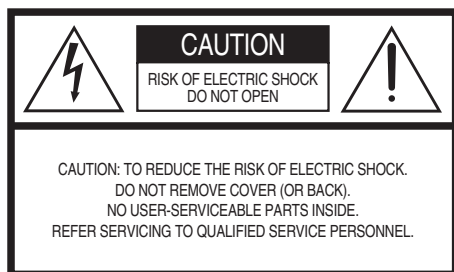

See bottom of Keyboard enclosure for graphic symbol markings.



The exclamation point within the equilateral triangle is intended to alert the user to the presence of important operating and maintenance (servicing) instructions in the literature accompanying the product.



The lightning flash with arrowhead symbol, within the equilateral triangle, is intended to alert the user to the presence of uninsulated “dangerous voltage” within the product’s enclosure that may be of sufficient magnitude to constitute a risk of electrical shock.

IMPORTANT NOTICE: All Yamaha electronic products are tested and approved by an independent safety testing laboratory in order that you may be sure that when it is properly installed and used in its normal and customary manner, all foreseeable risks have been eliminated. **DO NOT** modify this unit or commission others to do so unless specifically authorized by Yamaha. Product performance and/or safety standards may be diminished. Claims filed under the expressed warranty may be denied if the unit is/has been modified. Implied warranties may also be affected.

SPECIFICATIONS SUBJECT TO CHANGE: The information contained in this manual is believed to be correct at the time of printing. However, Yamaha reserves the right to change or modify any of the specifications without notice or obligation to update existing units.

ENVIRONMENTAL ISSUES: Yamaha strives to produce products that are both user safe and environmentally friendly. We sincerely believe that our products and the production methods used to produce them, meet these goals. In keeping with both the letter and the spirit of the law, we want you to be aware of the following:

Battery Notice: This product MAY contain a small non-rechargeable battery which (if applicable) is soldered in place. The average life span of this type of battery is approximately five years. When replacement becomes necessary, contact a qualified service representative to perform the replacement.

Warning: Do not attempt to recharge, disassemble, or incinerate this type of battery. Keep all batteries away from children. Dispose of used batteries promptly and as regulated by applicable laws. Note: In some areas, the servicer is required by law to return the defective parts. However, you do have the option of having the servicer dispose of these parts for you.

Disposal Notice: Should this product become damaged beyond repair, or for some reason its useful life is considered to be at an end, please observe all local, state, and federal regulations that relate to the disposal of products that contain lead, batteries, plastics, etc.

NOTICE: Service charges incurred due to lack of knowledge relating to how a function or effect works (when the unit is operating as designed) are not covered by the manufacturer’s warranty, and are therefore the owners responsibility. Please study this manual carefully and consult your dealer before requesting service.

NAME PLATE LOCATION: The graphic below indicates the location of the name plate. The model number, serial number, power requirements, etc., are located on this plate. You should record the model number, serial number, and the date of purchase in the spaces provided below and retain this manual as a permanent record of your purchase.

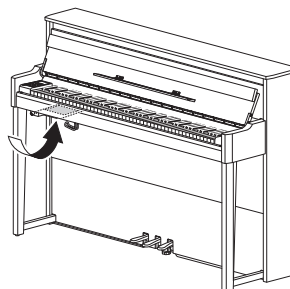

Model _____

Serial No. _____

Purchase Date _____

FCC INFORMATION (U.S.A.)

1. IMPORTANT NOTICE: DO NOT MODIFY THIS UNIT!

This product, when installed as indicated in the instructions contained in this manual, meets FCC requirements. Modifications not expressly approved by Yamaha may void your authority, granted by the FCC, to use the product.

2. IMPORTANT:

When connecting this product to accessories and/or another product use only high quality shielded cables. Cable/s supplied with this product MUST be used. Follow all installation instructions. Failure to follow instructions could void your FCC authorization to use this product in the USA.

3. NOTE:

This product has been tested and found to comply with the requirements listed in FCC Regulations, Part 15 for Class "B" digital devices. Compliance with these requirements provides a reasonable level of assurance that your use of this product in a residential environment will not result in harmful interference with other electronic devices. This equipment generates/uses radio frequencies and, if not installed and used according to the instructions found in the users manual, may cause interference harmful to the operation of other electronic devices. Compliance with FCC regulations does not guarantee

that interference will not occur in all installations. If this product is found to be the source of interference, which can be determined by turning the unit "OFF" and "ON", please try to eliminate the problem by using one of the following measures:

Relocate either this product or the device that is being affected by the interference.

Utilize power outlets that are on different branch (circuit breaker or fuse) circuits or install AC line filter/s.

In the case of radio or TV interference, relocate/reorient the antenna. If the antenna lead-in is 300 ohm ribbon lead, change the lead-in to co-axial type cable.

If these corrective measures do not produce satisfactory results, please contact the local retailer authorized to distribute this type of product. If you can not locate the appropriate retailer, please contact Yamaha Corporation of America, Electronic Service Division, 6600 Orangethorpe Ave, Buena Park, CA90620

The above statements apply ONLY to those products distributed by Yamaha Corporation of America or its subsidiaries.

* This applies only to products distributed by YAMAHA CORPORATION OF AMERICA.

(class B)

COMPLIANCE INFORMATION STATEMENT (DECLARATION OF CONFORMITY PROCEDURE)

Responsible Party : Yamaha Corporation of America
Address : 6600 Orangethorpe Ave., Buena Park, Calif. 90620
Telephone : 714-522-9011
Type of Equipment : Hybrid Piano
Model Name : NU1X

This device complies with Part 15 of the FCC Rules.

Operation is subject to the following two conditions:

- 1) this device may not cause harmful interference, and
- 2) this device must accept any interference received including interference that may cause undesired operation.

See user manual instructions if interference to radio reception is suspected.

* This applies only to products distributed by YAMAHA CORPORATION OF AMERICA.

(FCC DoC)

OBSERVERA!

Apparaten kopplas inte ur växelströmskällan (nätet) så länge som den är ansluten till vägguttaget, även om själva apparaten har stängts av.

ADVARSEL: Netspændingen til dette apparat er IKKE afbrudt, så længe netledningen sidder i en stikkontakt, som er tændt — også selvom der er slukket på apparatets afbryder.

VAROITUS: Laitteen toisiopiiriin kytketty käyttökytin ei irroita koko laitetta verkosta.

(standby)

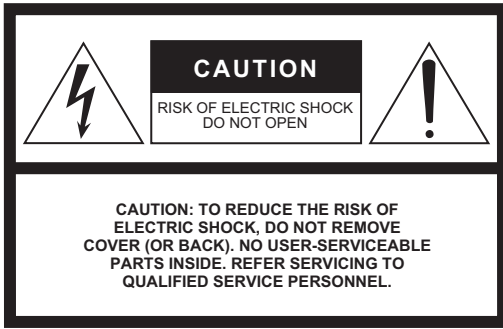

The above warning is located on the bottom of the unit.

Explanation of Graphical Symbols



The lightning flash with arrowhead symbol within an equilateral triangle is intended to alert the user to the presence of uninsulated “dangerous voltage” within the product’s enclosure that may be of sufficient magnitude to constitute a risk of electric shock to persons.



The exclamation point within an equilateral triangle is intended to alert the user to the presence of important operating and maintenance (servicing) instructions in the literature accompanying the product.

IMPORTANT SAFETY INSTRUCTIONS

- 1 Read these instructions.
- 2 Keep these instructions.
- 3 Heed all warnings.
- 4 Follow all instructions.
- 5 Do not use this apparatus near water.
- 6 Clean only with dry cloth.
- 7 Do not block any ventilation openings. Install in accordance with the manufacturer’s instructions.
- 8 Do not install near any heat sources such as radiators, heat registers, stoves, or other apparatus (including amplifiers) that produce heat.
- 9 Do not defeat the safety purpose of the polarized or grounding-type plug. A polarized plug has two blades with one wider than the other. A grounding type plug has two blades and a third grounding prong. The wide blade or the third prong are provided for your safety. If the provided plug does not fit into your outlet, consult an electrician for replacement of the obsolete outlet.
- 10 Protect the power cord from being walked on or pinched particularly at plugs, convenience receptacles, and the point where they exit from the apparatus.

- 11 Only use attachments/accessories specified by the manufacturer.
- 12 Use only with the cart, stand, tripod, bracket, or table specified by the manufacturer, or sold with the apparatus. When a cart is used, use caution when moving the cart/apparatus combination to avoid injury from tip-over.
- 13 Unplug this apparatus during lightning storms or when unused for long periods of time.
- 14 Refer all servicing to qualified service personnel. Servicing is required when the apparatus has been damaged in any way, such as power-supply cord or plug is damaged, liquid has been spilled or objects have fallen into the apparatus, the apparatus has been exposed to rain or moisture, does not operate normally, or has been dropped.



WARNING

TO REDUCE THE RISK OF FIRE OR ELECTRIC SHOCK, DO NOT EXPOSE THIS APPARATUS TO RAIN OR MOISTURE.

(UL60065_03)

The model number, serial number, power requirements, etc., may be found on or near the name plate, which is at the bottom of the unit. You should note this serial number in the space provided below and retain this manual as a permanent record of your purchase to aid identification in the event of theft.

Model No.

Serial No.

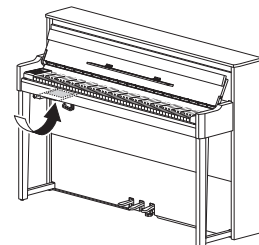

The name plate is located on the bottom of the unit.

(bottom_en_01)

PRECAUTIONS

PLEASE READ CAREFULLY BEFORE PROCEEDING

Please keep this manual in a safe and handy place for future reference.



WARNING

Always follow the basic precautions listed below to avoid the possibility of serious injury or even death from electrical shock, short-circuiting, damages, fire or other hazards. These precautions include, but are not limited to, the following:

Power supply/Power cord

- Do not place the power cord near heat sources such as heaters or radiators. Also, do not excessively bend or otherwise damage the cord, or place heavy objects on it.
- Only use the voltage specified as correct for the instrument. The required voltage is printed on the name plate of the instrument.
- Use only the supplied power cord/plug.
- Check the electric plug periodically and remove any dirt or dust which may have accumulated on it.

Do not open

- This instrument contains no user-serviceable parts. Do not open the instrument or attempt to disassemble or modify the internal components in any way. If it should appear to be malfunctioning, discontinue use immediately and have it inspected by qualified Yamaha service personnel.

Location (if *Bluetooth* functionality is included)

(For information on whether *Bluetooth* functionality is included or not, refer to page 40.)

- Radio waves may affect electro-medical devices.
 - Do not use this product near medical devices or inside areas in which the use of radio waves is restricted.
 - Do not use this product within 15cm (6 in.) of persons with a heart pacemaker implant.

Water warning

- Do not expose the instrument to rain, use it near water or in damp or wet conditions, or place on it any containers (such as vases, bottles or glasses) containing liquids which might spill into any openings. If any liquid such as water seeps into the instrument, turn off the power immediately and unplug the power cord from the AC outlet. Then have the instrument inspected by qualified Yamaha service personnel.
- Never insert or remove an electric plug with wet hands.

Fire warning

- Do not put burning items, such as candles, on the unit. A burning item may fall over and cause a fire.

If you notice any abnormality

- When one of the following problems occur, immediately turn off the power switch and disconnect the electric plug from the outlet. Then have the device inspected by Yamaha service personnel.
 - The power cord or plug becomes frayed or damaged.
 - It emits unusual smells or smoke.
 - Some object has been dropped into the instrument.
 - There is a sudden loss of sound during use of the instrument.



CAUTION

Always follow the basic precautions listed below to avoid the possibility of physical injury to you or others, or damage to the instrument or other property. These precautions include, but are not limited to, the following:

Power supply/Power cord

- Do not connect the instrument to an electrical outlet using a multiple-connector. Doing so can result in lower sound quality, or possibly cause overheating in the outlet.
- When removing the electric plug from the instrument or an outlet, always hold the plug itself and not the cord. Pulling by the cord can damage it.
- Remove the electric plug from the outlet when the instrument is not to be used for extended periods of time, or during electrical storms.

Location

- Do not place the instrument in an unstable position where it might accidentally fall over.
- When transporting or moving the instrument, always use two or more people. Attempting to lift the instrument by yourself may damage your back, result in other injury, or cause damage to the instrument itself.
- Before moving the instrument, remove all connected cables, to prevent damage to the cables or injury to anyone who might trip over them.
- When setting up the product, make sure that the AC outlet you are using is easily accessible. If some trouble or malfunction occurs, immediately turn off the power switch and disconnect the plug from the outlet. Even when the power switch is turned off, electricity is still flowing to the product at the minimum level. When you are not using the product for a long time, make sure to unplug the power cord from the wall AC outlet.

- Though the wooden parts of this instrument have been designed and produced with care concerning the environment and human health, in some rare instances customers may sense an unusual odor or develop irritation in the eyes, due to the coating material and adhesive.

To avoid this, we recommend that you observe the following:

1. Specially ventilate the room for several days after unpacking and installing this instrument, since it has been packed in airtight conditions in order to maintain quality during transportation.
2. If the room housing the instrument is small, continue to ventilate it normally, either daily or periodically.
3. If you have left the instrument in a closed room for a long time under high temperature, ventilate the room, then lower the temperature if possible before using the instrument.

Connections

- Before connecting the instrument to other electronic components, turn off the power for all components. Before turning the power on or off for all components, set all volume levels to minimum.
- Be sure to set the volumes of all components at their minimum levels and gradually raise the volume controls while playing the instrument to set the desired listening level.

Handling caution

- Do not insert a finger or hand in any gaps on the fallboard or instrument. Also take care that the fallboard does not pinch your finger.
- Do not apply excessive force when closing the fallboard.
A fallboard equipped with the SOFT-CLOSE™ mechanism closes the cover slowly. Applying excessive force to the fallboard when closing it could damage the SOFT-CLOSE™ mechanism, and possibly result in injury to your hands and fingers caught under the closing the fallboard.

- Never insert or drop paper, metallic, or other objects into the gaps on the fallboard, panel or keyboard. This could cause physical injury to you or others, damage to the instrument or other property, or operational failure.
- Do not rest your weight on, or place heavy objects on the instrument, and do not use excessive force on the buttons, switches or connectors.
- Do not use the instrument/device or headphones for a long period of time at a high or uncomfortable volume level, since this can cause permanent hearing loss. If you experience any hearing loss or ringing in the ears, consult a physician.

Using the bench (If included)

- Do not place the bench in an unstable position where it might accidentally fall over.
- Do not play carelessly with or stand on the bench. Using it as a tool or stepladder or for any other purpose might result in accident or injury.
- Only one person should sit on the bench at a time, in order to prevent the possibility of accident or injury.
- For benches that can be adjusted, do not adjust the bench height while sitting on the bench, since this can cause excessive force to be imposed on the adjustment mechanism, possibly resulting in damage to the mechanism or even injury.
- If the bench screws become loose due to extensive long-term use, tighten them periodically using the specified tool in order to prevent the possibility of accident or injury.
- Keep special watch over any small children so that they don't fall off the rear of the bench. Since the bench does not have a backrest, unsupervised use may result in accident or injury.

Yamaha cannot be held responsible for damage caused by improper use or modifications to the instrument, or data that is lost or destroyed.

Always turn the power off when the instrument is not in use.

Even when the [] (Standby/On) switch is in standby status (power lamp is off), electricity is still flowing to the instrument at the minimum level.

NOTICE

To avoid the possibility of malfunction/ damage to the product, damage to data, or damage to other property, follow the notices below.

■ Handling

- Do not use the instrument in the vicinity of a TV, radio, stereo equipment, mobile phone, or other electric devices. Otherwise, the instrument, TV, or radio may generate noise. When you use the instrument along with an application on your iPad, iPhone or iPod touch, we recommend that you set "Airplane Mode" to "ON" on that device in order to avoid noise caused by communication.
- Do not expose the instrument to excessive dust or vibrations, or extreme cold or heat (such as in direct sunlight, near a heater, or in a car during the day) to prevent the possibility of panel discoloration, damage to the internal components or unstable operation. (Verified operating temperature range: 5° – 40°C, or 41° – 104°F.)
- Do not place vinyl, plastic or rubber objects on the instrument, since this might discolor the panel or keyboard.
- In the case of a model with a polished finish, bumping the surface of the instrument with metal, porcelain, or other hard objects can cause the finish to crack or peel. Use caution.

■ Maintenance

- When cleaning the instrument, use a soft and dry/slightly damp cloth. Do not use paint thinners, solvents, alcohol, cleaning fluids, or chemical-impregnated wiping cloths.
- In the case of a model with a polished finish, gently remove dust and dirt with a soft cloth. Do not wipe too hard since small particles of dirt can scratch the instrument's finish.
- During extreme changes in temperature or humidity, condensation may occur and water may collect on the surface of the instrument. If water is left, the wooden parts may absorb the water and be damaged. Make sure to wipe any water off immediately with a soft cloth.

■ Saving data

- Some of the data of this instrument (page 34) and the Song data saved to the internal memory of this instrument (page 28) are retained when the power is turned off. However, the saved data may be lost due to some failure, an operation mistake, etc. Save the Song data onto USB flash drive/an external device such as a computer (pages 33, 37). Before using a USB flash drive, make sure to refer to page 31.
- To protect against data loss through USB flash drive damage, we recommend that you save your important data onto spare USB flash drive or an external device such as a computer as backup data.

Information

■ About copyrights

- Copying of the commercially available musical data including but not limited to MIDI data and/or audio data is strictly prohibited except for your personal use.
- This product incorporates and bundles contents in which Yamaha owns copyrights or with respect to which Yamaha has license to use others' copyrights. Due to copyright laws and other relevant laws, you are NOT allowed to distribute media in which these contents are saved or recorded and remain virtually the same or very similar to those in the product.
 - * The contents described above include a computer program, Accompaniment Style data, MIDI data, WAVE data, voice recording data, a score, score data, etc.
 - * You are allowed to distribute medium in which your performance or music production using these contents is recorded, and the permission of Yamaha Corporation is not required in such cases.

■ About functions/data bundled with the instrument

- Some of the preset songs have been edited for length or arrangement, and may not be exactly the same as the original.

■ About this manual

- The illustrations and LCD screens as shown in this manual are for instructional purposes only, and may appear somewhat different from those on your instrument.
- iPhone, iPad, iPod touch are trademarks of Apple Inc., registered in the U.S. and other countries.
- The *Bluetooth*® word mark and logos are registered trademarks owned by *Bluetooth* SIG, Inc. and any use of such marks by Yamaha Corporation is under license.
- The company names and product names in this manual are the trademarks or registered trademarks of their respective companies.

■ About Bluetooth

- For information on handling *Bluetooth* communications, refer to "About *Bluetooth*" on page 40.

■ Tuning

- Unlike an acoustic piano, this instrument does not need to be tuned by an expert (although the pitch can be user-adjusted to match other instruments). However, since the keyboard mechanism of this instrument is the same as that of an actual piano, the mechanism may change over years of use. If this occurs or causes problems in performance, contact your Yamaha dealer.

Transporting / Installing

If you move to another location, transport the instrument horizontally. Do not subject the instrument to excessive vibration or shock.



CAUTION

When moving the instrument, always hold the bottom of the keyboard unit and the handgrips of the rear side. Be sure not to hold the headphone jack box. Improper handling can result in damage to the instrument or personal injury.

Place the instrument away from the wall by at least 10 cm to optimize and enhance the sound effect. If you find the instrument shaky or unstable after installing, insert the included felt strips. For details, refer to the instructions supplied with the felt strips.

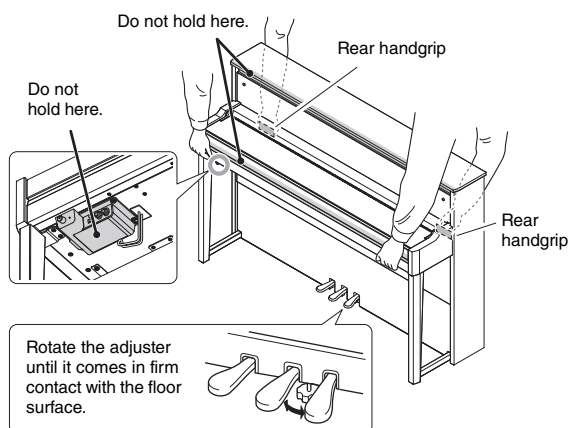



Hybrid Piano

AVANT GRAND NU1X

Combining over a century of experience in crafting world-class pianos with the latest in advanced technology, Yamaha proudly introduces an instrument that is closer than ever to an actual acoustic piano—equipped with every essential element pianists demand.

Authentic acoustic piano touch with special upright piano action and piano keyboard

The AvantGrand NU1X features a specially designed mechanism in which the keyboard action and the hammer workings realistically reproduce those of an acoustic piano.

Moreover, the wood construction of the keyboard is the same as on an upright piano, giving the instrument even a more realistic acoustic piano-like touch response.

Enjoy performing and practicing with the sound of famous grand pianos

This instrument puts the sound of several different renowned grand pianos at your fingertips, including the CFX, Yamaha's flagship concert grand piano—which delivers dynamic sound, from a brilliant high-range to powerful bass—and the Bosendorfer* Imperial, a flagship grand piano known for its subtle and warm sound.

* Bosendorfer is a subsidiary company of Yamaha.

Natural sound distance sensation for headphone play ➤➤ Page 15

This instrument features a binaural sampling sound designed especially for use with headphones. Binaural sampling is a method which uses two microphones placed where the ears of a performer would be and records that piano sound. Listening to the sound created through this method with headphones gives the impression of being immersed in the sound, as if it was actually emanating from the piano.

Always in optimum condition, no need for tuning

Unlike acoustic pianos, this instrument does not need to be tuned. It always stays perfectly in tune even after long-time use.

Playback and Recording functions to support your lessons and practice ➤➤ Page 26, 28, 39

You can record your performance to this instrument and a USB flash drive, and improve your performance by listening to the recording. Furthermore, this instrument has a *Bluetooth* audio function, letting you play back audio data on this instrument by connecting with a *Bluetooth*-equipped device via *Bluetooth*.

Table of Contents

PRECAUTIONS 5

Setting Up

Getting started playing your new Avant Grand!

Panel Controls and Terminals 10
Playing the Keyboard 11
 Opening/Closing the Fallboard and the Music Rest 11
 Turning the Power On/Off..... 12
 Confirming the firmware version of this instrument 13
 Adjusting the Master Volume..... 14
 Using Headphones 15
 Using the Pedals 16

Main Operations

This section explains how to make detailed settings for the instrument's various functions.

Basic Operations and More 17
 Selecting a Voice 17
 Listening to the Voice Demo Songs 18
 Using the Metronome 19
 Adjusting the Tempo..... 20
 Changing the Touch Sensitivity 20
 Playing the Realistic Resonance-enhanced VRM
 Voices 21
 Enhancing the Sound with Reverb 22
 Transposing the Pitch in Semitones 23
 Fine-tuning the Pitch..... 23
 Setting the Scale Tuning 24
Playing Back Songs 25
 Songs compatible with this instrument 25
 Playing Back Songs..... 26

Recording Your Performance 28
 Deleting a Song file 30
Using USB Flash Drives 31
 About USB Devices 31
 Formatting USB Flash Drive 32
 Managing files on a USB flash drive 32
 Copying User Songs in the Instrument to USB Flash
 Drive 33
Backup Data and Initialization 34
 Backup Data in Internal Memory 34
 Initializing the Backup Data 34
Connections 35
 Jacks and Terminals 35
 Connecting Audio Devices ([AUX IN] jack,
 AUX OUT [L/L+R] [R] jacks) 35
 Connecting External MIDI Devices (MIDI [IN] [OUT]
 terminals) 36
 Connecting to a Computer ([USB TO HOST] terminal) ... 37
 Connecting to a smart device such as iPhone/iPad
 ([USB TO DEVICE]/ [USB TO HOST],
 MIDI [IN][OUT] terminals) 38
 Using the *Bluetooth* audio function 39
 About *Bluetooth** 40

Appendix

This section includes a list of display messages, Quick Operation Guide and other information.

Message List 41
Troubleshooting..... 42
Preset Song List (50 Classical Music Masterpieces) .. 43
Specifications..... 44
Index..... 45
Quick Operation Guide** 46

* For information on whether *Bluetooth* functionality is included or not, refer to page 40.

** This is a quick reference for operation of the functions assigned to the buttons and keyboard.

About Manuals

This instrument has the following documents and instructional materials.

■ Included Documents



Owner's Manual (this book)

This manual describes how to use this instrument.

■ Online Materials (from Yamaha Downloads)



iPhone/iPad Connection Manual (only in English, French, German and Spanish)

Explains how to connect the instrument to smart devices, such as an iPhone, iPad, etc.



Computer-related Operations

Includes instructions on connecting this instrument to a computer, and operations related to transferring files and MIDI data.



MIDI Reference

Contains MIDI related information such as MIDI Data Format and the MIDI Implementation Chart.



MIDI Basics (only in English, French, German and Spanish)

Contains basic explanations about MIDI.

To obtain these manuals, access the Yamaha Downloads, enter the model name for searching the desired files.

Yamaha Downloads <http://download.yamaha.com/>

Included Accessories

- Owner's Manual (this book) ×1
- "50 Classical Music Masterpieces" (Music Book) ×1
- Online Member Product Registration ×1
 The "PRODUCT ID" on the sheet will be needed when you fill out the User Registration form.
- Warranty* ×1

- Felt key cover ×1
- Power cord ×1
- Bench* ×1
- * May not be included depending on your area. Check with your Yamaha dealer.
- Felt strip set ×1

Panel Controls and Terminals

Overview

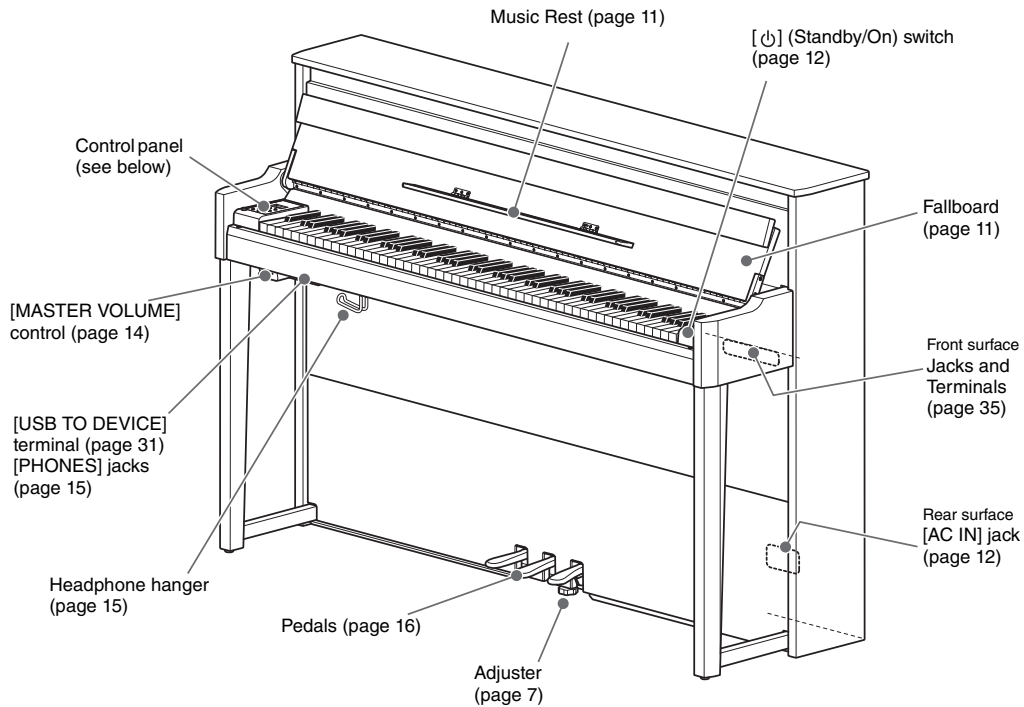

Control Panel

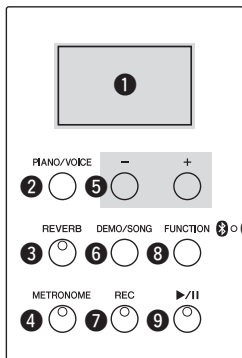

- ❶ Display See below.
- ❷ [PIANO/VOICE] button pages 15, 16, 17, 20, 21
- ❸ [REVERB] button page 22
- ❹ [METRONOME] button pages 19, 20
- ❺ [+]/[-] button
- ❻ [DEMO/SONG] button pages 18, 26, 28
- ❼ [REC] button page 29
- ❽ [FUNCTION] button pages 23, 46
- ❾ [▶/||] (PLAY/PAUSE) button pages 26, 29
- ❿ (Bluetooth lamp) page 39

Square brackets []

The names of panel buttons, jacks, connectors, and so on are enclosed in square brackets. Also, the word “button” is omitted throughout this manual (for example, the PIANO/VOICE button is expressed as [PIANO/VOICE]).

Display

Indicates various values such as Song number and Parameter value. Note that the display turns dark after the value is set.

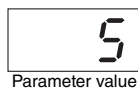
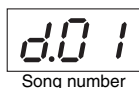

This display also indicates various messages with the three characters. For details, refer to page 41.

Playing the Keyboard

Opening/Closing the Fallboard and the Music Rest

To raise the fallboard and the music rest

- 1 With both hands, hold the hand grip, then lift and open the fallboard.
- 2 Fold down the top of the fallboard.
- 3 Open the music rest.

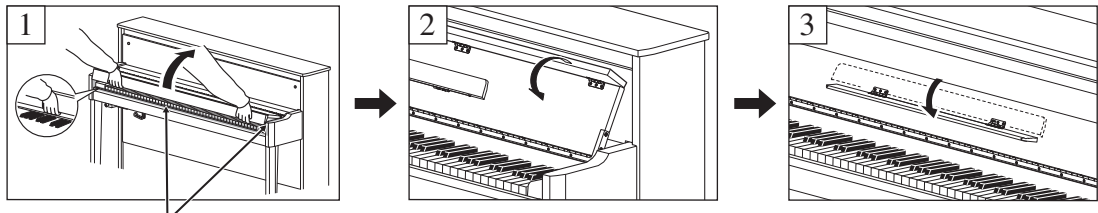

CAUTION
Be careful to avoid catching your fingers between the fallboard and the instrument.

To lower the fallboard and the music rest

- 1 Close the music rest.
If you omit this operation and close the fallboard, the music rest will hit the keyboard and may result in damage.
- 2 With both hands, open the folded top of the fallboard, and close it gently.
The fall board is equipped with the special SOFT-CLOSE™ mechanism which closes the cover slowly.

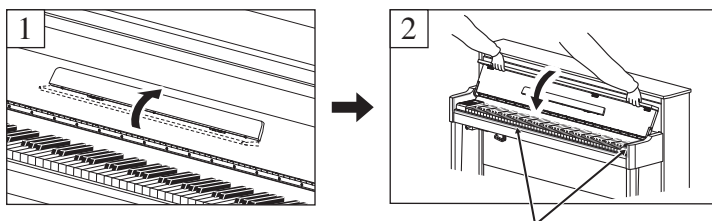

CAUTION
Be careful to avoid catching your fingers between the fallboard and the instrument.

CAUTION

- Hold the fallboard with both hands when opening or closing it. Do not release it until it is fully opened or closed. Be careful to avoid catching fingers (yours or others, especially children's) between the fallboard and the unit.
- Do not apply excessive force when closing the fallboard. Applying excessive force to the fallboard when closing it could damage the SOFT-CLOSE™ mechanism, and possibly result in injury to your hands and fingers caught under the closing fallboard.
- Do not place anything (such as metal objects or pieces of paper) on top of the fallboard. Small objects placed on the fallboard may fall inside the unit when the fallboard is opened and may be nearly impossible to remove. Once inside, they could cause electric shock, short circuit, fire or other serious damage to the instrument.

Turning the Power On/Off

1 Connect the power cord in the order shown in the illustration.

Refer to the “Panel Controls and Terminals” on page 10 for information on the location of the [AC IN] jack.

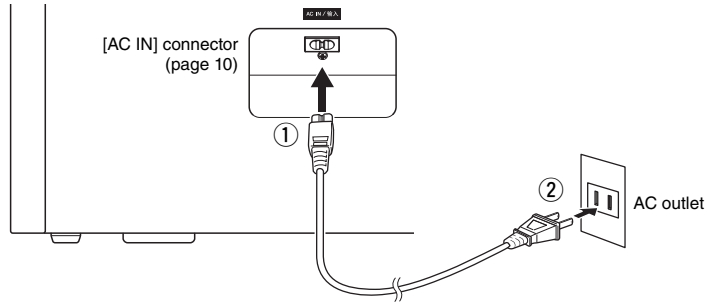

When disconnecting the power cord, first turn off the power, then follow this procedure in reverse order.

⚠ WARNING

Use only the AC power cord supplied with the instrument. If the supplied power cord is lost or damaged and needs to be replaced, contact your Yamaha dealer. The use of an inappropriate replacement can pose a fire and shock hazard!

⚠ WARNING

The type of AC power cord provided with the instrument may be different depending on the country in which the instrument was purchased. (In some areas a plug adaptor may be provided to match the pin configuration of the AC wall outlets in your area.) Do NOT modify the plug provided with the instrument. If the plug will not fit the outlet, have a proper outlet installed by a qualified electrician.

⚠ CAUTION

When setting up the product, make sure that the AC outlet you are using is easily accessible. If some trouble or malfunction occurs, immediately turn off the power switch and disconnect the plug from the outlet.

2 Turn down the [MASTER VOLUME] control to “MIN.”

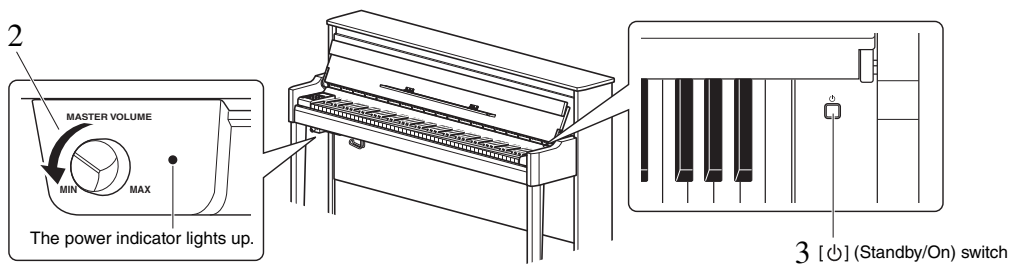

3 Press the [⏻] (Standby/On) switch on the right of the keyboard to turn the power on.

The power indicator located on the right of the [MASTER VOLUME] control lights up. The display indicators flash in a pattern, indicating the instrument is currently starting up, and stop flashing when startup is completed.

NOTICE

Do not press any keys, buttons or pedals until the instrument has completely started up (roughly five seconds after turning on the switch). Doing so may cause some keys to not play normally or some other malfunction to occur.

4 Play the keyboard.

While playing the keyboard, adjust the volume level by using the [MASTER VOLUME] control located at the left of the panel.



5 Turn off the power by pressing the [⏻] (Standby/On) switch for about a second.

The power gradually turns off.

⚠ CAUTION

Even after the power switch is turned off, electricity is still flowing to the instrument at the minimum level. Remove the electric plug from the outlet when the instrument is not to be used for extended periods of time, or during electrical storms.

Auto Power Off function

To prevent unnecessary power consumption, this instrument features an Auto Power Off function that automatically turns the power off if the instrument is not operated for approximately 30 minutes.

Disabling Auto Power Off (simple method)

Turn the power on while holding down the lowest key on the keyboard.

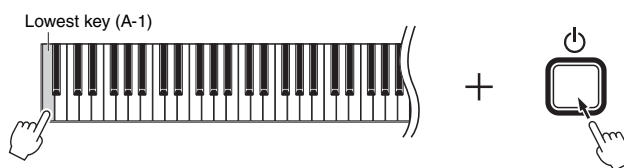

The indication “P_oF” appears on the display briefly and Auto Power Off is disabled.

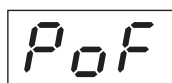

Disabling or enabling the Auto Power Off setting

While the power is on, simultaneously hold down [FUNCTION] and press the A5 key. Pressing the A5 key repeatedly in this condition toggles between “OFF” (disabled) and “On” (enabled), and the setting appears on the display.

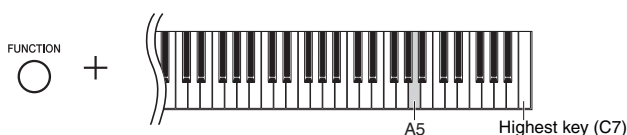

Confirming the firmware version of this instrument

You can confirm the firmware version of your instrument.

While holding down [FUNCTION], press the B5 key. The current version appears on the display.

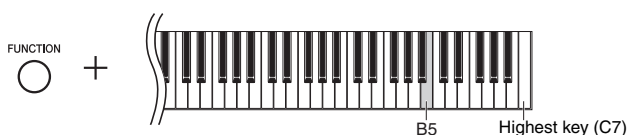

About the latest Firmware Version

Yamaha may from time to time update firmware of the product without notice for improvement.

Make sure to check our website for information of the latest release and upgrade the firmware for your instrument.

Adjusting the Master Volume

To adjust the volume level by using the [MASTER VOLUME] control located at the front left, just below the keyboard while playing the keyboard.

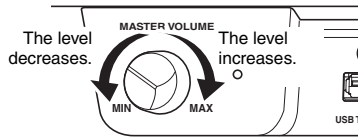

⚠ CAUTION

Do not use this instrument at a high volume level for a long period of time, or your hearing may be damaged.

Intelligent Acoustic Control (IAC)

This function automatically adjusts and controls the sound quality according to the overall volume of the instrument. Even when the volume is low, it permits both low sounds and high sounds to be clearly heard. Note that the IAC is effective only from the sound output of the instrument speakers.

● To turn on/off the IAC:

While holding down [FUNCTION], press the C0 key repeatedly (if necessary).

Default setting: On

● To adjust the IAC Depth:

While holding down [FUNCTION], press one of the keys between A0–D#1.

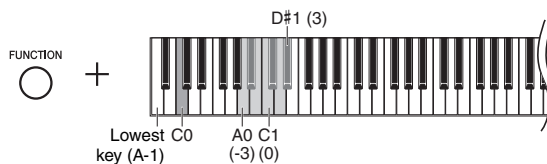

Setting range: -3 (A0) – 0 (C1) – 3 (D#1)

Default setting: 0 (C1)

The higher the value, the more clearly that low and high sounds are heard at lower volume levels.

Using Headphones

Since this instrument is equipped with two [PHONES] jacks, you can connect two sets of standard stereo headphones. If you are using only one set of headphones, insert a plug into either jack; this automatically shuts off the speakers.

⚠ CAUTION

Avoid listening to the instrument at a high volume level through headphones for a long period of time, to prevent hearing damage.

NOTICE

Do not hang anything other than the headphones on the hanger. Otherwise, the instrument or the hanger may be damaged.

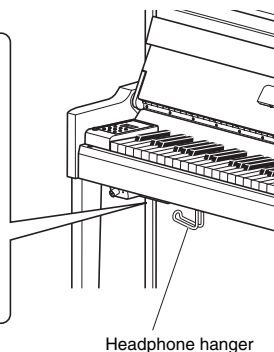
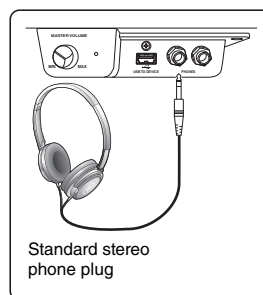

Reproducing the Natural Sound Distance Sensation (when using Headphones)—Binaural Sampling and Stereophonic Optimizer

This instrument features two advanced technologies that allow you to enjoy exceptionally realistic, natural sound, even though listening on headphones.

● Binaural Sampling (“CFX Grand” Voice only)

Binaural sampling is a method that uses two special microphones set at the ear position of a performer and records the sound from a piano as it is. Listening to the sound with this effect through headphones gives the impression of being immersed in the sound, as if it was actually emanating from the piano. Moreover, you can enjoy the sound naturally for a long time without ear strain. When the default Voice, “CFX Grand” (page 17) is selected, connecting the headphones automatically enables the binaural sampling sound.

● Stereophonic Optimizer (Piano Voices other than “CFX Grand”)

The Stereophonic Optimizer is an effect which reproduces natural sound distance like the sound of binaural sampling even though you hear it on headphones. When one of the Piano Voices other than “CFX Grand” (Display numbers 2–5; page 17) is selected, connecting headphones enable the Stereophonic Optimizer.

Turning the Binaural Sampling and Stereophonic Optimizer function on/off

When headphones are connected, the sound from this instrument changed to the sound of Binaural Sampling or the sound enhanced with the Stereophonic Optimizer. Since these sounds are optimized for listening with headphones, we recommend that you set this function to “OFF” (as described below).

You should turn these functions off when:

- Playing the sound of this instrument with an external powered speaker system or a mixer, while monitoring the sound output from this instrument on connected headphones.
- Making an audio recording (page 28) and then playing that recorded audio Song through speakers. (Make sure to turn off these functions before audio recording.)

NOTE

Before connecting an external powered speaker system, be sure to read “Using an External Stereo System for Playback—AUX OUT [L/L+R] [R] jacks” (page 36).

While holding down [PIANO/VOICE], press the C6 key repeatedly (if necessary) to turn this function on/off. The specified value is shown on the display while both controls are held.

Default setting: On

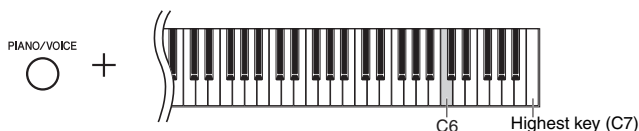

Using the Pedals

The instrument has three pedals that produce a range of expressive effects similar to those produced by the pedals on an acoustic piano.

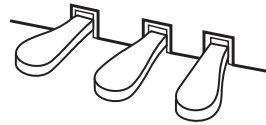

Damper Pedal (Right)

Pressing this pedal will sustain notes longer. Releasing this pedal immediately stops (damps) any sustained notes. The damper pedal features a half-pedal function.



↑ If you press and hold the damper pedal here, all the notes shown will be sustained.

● Half-pedal function

This function allows the sustain length to vary depending on how far the pedal is pressed. The farther you press the pedal, the more the sound sustains. For example, if you press the damper pedal and all notes you are playing sound a bit murky and loud with too much sustain, you can release the pedal half way to subdue the sustain (murkiness).

● To set the Half Pedal Point:

While holding down [PIANO/VOICE], press one of the A#4–E5 keys. This operation sets the degree to which pressing the damper pedal applies the half-pedal effect. The smaller the value, the shallower the half-pedal point. The larger the value, the deeper the half-pedal point.

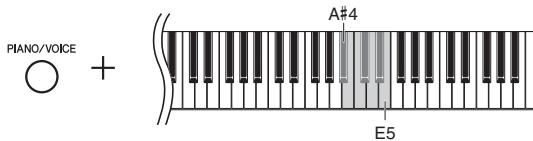

Setting range: -2 (A#4) – 4 (E5)
Default Setting: 0

GP Responsive Damper Pedal

This special pedal has been designed to provide enhanced tactile response and, when pressed, is much closer in feel to the pedal of an actual grand piano. It makes it easier to physically experience the half-pedal point and more easily apply the half-pedal effect than other pedals.

Sostenuto Pedal (Center)

Pressing this pedal while holding the notes will sustain the pressed notes (as if the damper pedal had been pressed), but all subsequently played notes will not be sustained. This makes it possible to sustain a chord, for example, while the other notes are played “staccato.”



↑ If you press and hold the sostenuto pedal here, only the notes held at this timing will be sustained.

Soft Pedal (Left)

Pressing this pedal will reduce the volume and slightly change the timbre of the notes. The notes played before this pedal is pressed are not affected.

NOTE

While the sostenuto pedal is held, the Organ (Display numbers 12–14; page 17) or Piano + Strings (Display number 15) Voices sound continuously without decay after the notes have been released.

Basic Operations and More

Selecting a Voice

● To select the CFX Grand Voice:

Simply press [PIANO/VOICE]. “1” will appear on the display.

● To select a different Voice:

While holding down [PIANO/VOICE], press [+] or [-]. Pressing the buttons switches through the 15 Voices in numerical order, as indicated in the Voice List below.

Voice List

Display	Voice name	Descriptions	VRM*
	CFX Grand	Yamaha's CFX concert grand piano sound with a wide dynamic range for maximum expressive control. It is suitable for playing in any music genre and style. When headphones are connected, this Voice is automatically changed to “Binaural CFX Grand” (below).	○
1	Binaural CFX Grand	Yamaha's CFX concert grand piano sound sampled by Binaural Sampling, the method optimized for headphone use. Listening this through headphones gives the impression of being immersed in the sound, as if it was actually emanating from the piano. This Voice is selected automatically when headphones are connected. Refer to page 18 for details. (This Voice cannot be selected following the procedure of “Selecting a Voice” instructions above.)	○
2	Bösendorfer Imperial	The famed sound of the Vienna-made Bösendorfer Imperial concert grand piano. Its spacious sound evokes the size of the instrument, and is ideal for expressing tenderness in compositions.	○
3	Studio Grand	The sound of Yamaha's C7 grand piano, which is often used in recording studios. Its bright and clear sound is good for popular styles.	○
4	Ballad Grand	Grand piano sound with a soft and warm tone. Good for playing ballads.	○
5	Upright Piano	The sound sampled from an upright piano, the Yamaha SU7. Enjoy the unique tonal character and a lighter, more casual feel.	○
6	Stage E.Piano	The sound of an electric piano using hammer-struck metallic “tines.” Soft tone when played lightly, and an aggressive tone when played hard.	-
7	DX E.Piano	An electronic piano sound produced by an FM synthesizer. The tone will change as you vary your playing touch. Ideal for popular music.	-
8	Vintage E.Piano	A different type of electric piano sound than Stage E.piano. Widely used in rock and popular music.	-
9	Harpsichord 8'	The sound of the instrument frequently used in baroque music. Variations in playing touch will not affect the volume, and a characteristic sound will be heard when you release the key.	-
10	Harpsi. 8'+4'	A harpsichord with an added upper octave. Produces a more brilliant sound.	-
11	Celesta	The sound of a celesta (a percussion instrument in which hammers strike metallic bars to produce sound). This instrument is well-known for its appearance in “Dance of the Sugarplum Fairies” from Tchaikovsky's “Nutcracker Suite.”	-
12	Organ Principal	This Voice features the combination of pipes (8'+4'+2') of a principal (brass instrument) organ. It is suitable for Baroque church music.	-
13	Organ Tutti	This Voice features a full coupler of a pipe organ, famous for the sound used in “Tocatta and Fugue” by Bach.	-
14	Jazz Organ	The sound of a “tonewheel” type electric organ. Sampled with Rotary SP effect, its rotation speed is slow. Often heard in jazz and rock idioms.	-
15	Piano + Strings	Combination of piano and strings ensemble Voices, giving you a richly textured sound as if you were playing the piano with orchestral accompaniment.	-

*VRM: Simulated string resonance sound with physical modeling when the damper pedal is pressed or keys are pressed. Refer to page 21 for details.

NOTE

To understand the characteristics of various Voices, listen to Demo Songs for each Voice (page 18).

Listening to the Voice Demo Songs

Demo Songs effectively demonstrate each of this instrument's Voices.

1 Select the Voice for the Demo Song that you want to listen to.

2 Press [DEMO/SONG].

The Demo Song for the Voice selected in Step 1 starts.

To change the Demo Song during playback:

Press [+] or [-].

To adjust the playback tempo:

While holding down [METRONOME], press [+] or [-].

To pause playback:

During playback, press [▶/||] (Play/Pause) to pause playback. Pressing it again resumes Demo Song playback from the current position.

3 Press [DEMO/SONG] again to stop playback.

Demo Song List

Display	Voice Name	Song Name	Composer
d01	CFX Grand Binaural CFX Grand	Variations brillantes op.12	F. F. Chopin
d02	Bösendorfer	Mädchens Wunsch (6 Chants polonaise S.480 R.145)	F. Liszt / F. F. Chopin
d03	Studio Grand	Original	-
d04	Ballad Grand	Original	-
d05	Upright Piano	Italienisches Konzert, BWV 971 1st mov.	J. S. Bach
d06	Stage E.Piano	Original	-
d07	DX E.Piano	Original	-
d08	Vintage E.Piano	Original	-
d09	Harpichord 8'	Concerto a cembalo obbligato, 2 violini, viola e continuo No.7, BWV 1058	J. S. Bach
d10	Harpsi. 8'+4'	Gigue, Französische Suiten No.5, BWV 816	J. S. Bach
d11	Celesta	Danse de la Fée Dragée	P. I. Tchaikovsky
d12	Organ Principal	Herr Christ, der ein'ge Gottes-Sohn, BWV 601	J. S. Bach
d13	Organ Tutti	Original	-
d14	Jazz Organ	Original	-
d15	Piano + Strings	Original	-

The Songs d03, d04, d06-d08, and d13-d15 are Yamaha's original pieces (©2017 Yamaha Corporation).

NOTE

You can play the keyboard along with the Demo Song.

NOTE

No MIDI data will be output during Voice Demo playback.

NOTE

The Binaural CFX Grand Voice is automatically selected when you select the CFX Grand Voice while headphones are connected. Refer to the "Voice List" on page 17 for details.

Using the Metronome

The metronome feature is convenient for practicing with an accurate tempo.

1 Press [METRONOME] to start the metronome.

While the metronome sounds, a dot at the right side of the LED display and the lamp of the metronome button flash on and off to the tempo.

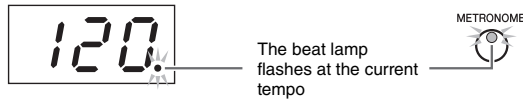

2 Press [METRONOME] again to stop the metronome.

Selecting the Beat

While holding down [METRONOME], press one of the C3–F3 keys. The selected value is shown on the display while both controls are held.

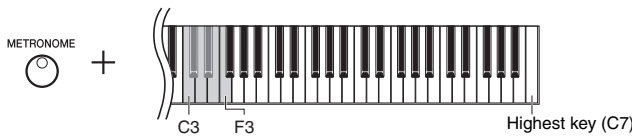

Default setting: 0 (No 1st beat accent)

NOTE

The Beat of the metronome is restored to the default setting when the power is turned off.

Display	Key	Beat	Display	Key	Beat
0	C3	0 (no 1st beat accent)	4	D#3	4
2	C#3	2	5	E3	5
3	D3	3	6	F3	6

Only the first beat is accented with a bell sound when set to a value other than 0.

Adjusting the Metronome volume

While holding down [METRONOME], press one of the C1–G2 keys to set the volume. The specified value is shown on the display while both controls are held.

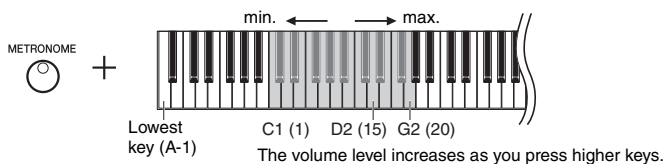

Setting range: 1–20
Default setting: 15

Adjusting the Tempo

The tempo of Metronome can be adjusted. You can also adjust the playback tempo of a MIDI Song (page 25) as well as the playback speed of an Audio Song (page 25) as they are playing.

● **To increase or decrease the value by 1:**

While holding down [METRONOME], press [+] (or the C#5 key) to increase or [-] (or the B4 key) to decrease. While only the Metronome is playing, simply press [+] or [-] to change the tempo of the Metronome.

● **To increase or decrease the value by 10:**

While holding down [METRONOME], press the D5 key to increase or the A#4 key to decrease.

● **To reset the value to the default:**

While holding down [METRONOME], press the C5 key or press [+] and [-] simultaneously. While only the Metronome is playing, simply press both [+] and [-] simultaneously to reset the Metronome to its default tempo.

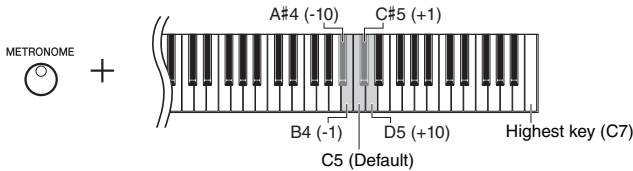

NOTE

Adjusting the tempo of Metronome cannot be done during the playback of Audio Songs (page 25).

Metronome

Setting range: 5 to 500 beats per minute
Default setting: 120

MIDI Song

Setting range: 5 to 500 beats per minute
Normal setting: Depends on the selected Song

Audio Song

Setting range: 75% to 125%
Normal setting: 100%

NOTE

The metronome tempo is restored to the default setting when the power is turned off.

Changing the Touch Sensitivity

You can specify the Touch Sensitivity (how the sound responds to the way you play the keys).

While holding down [PIANO/VOICE], press one of the A6–C7 keys. The selected Touch Sensitivity is shown on the display while both controls are held.

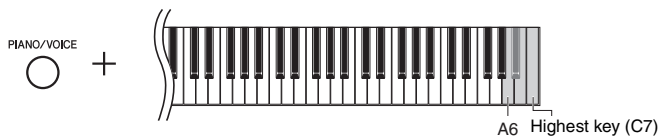

Display	Key	Touch Sensitivity	Descriptions
<i>OFF</i>	A6	Fixed	The volume level does not change at all regardless of whether you play the keyboard soft or hard.
<i>1</i>	A#6	Soft	The volume level does not change much when you play the keyboard soft or hard.
<i>2</i>	B6	Medium	This is the standard piano touch response.
<i>3</i>	C7	Hard	The volume level changes very widely from pianissimo to fortissimo to facilitate dynamic and dramatic expression. You have to hit the keys hard to produce a loud sound.

Default setting: 2 (Medium)

NOTE

The touch type is restored to the default setting when the power is turned off.

NOTE

This setting does not change the weight of the keyboard, but only the response.

Playing the Realistic Resonance-enhanced VRM Voices

On an actual acoustic piano, if you press the damper pedal and play a key, not only does the string of the pressed key vibrate, it also causes other strings and the soundboard to vibrate, with each influencing the rest, creating a rich and brilliant resonance that sustains and spreads. The VRM (Virtual Resonance Modeling) technology featured in the NU1X reproduces the complicated interaction of both string and soundboard resonance faithfully using a virtual musical instrument (physical modeling), and makes the sound more like a real acoustic piano. Since instantaneous resonance is made at the moment according to the state of the keyboard or pedal, you can vary the sound expressively by changing the timing of your pressing the keys, and the timing and depth of your pressing the pedal.

The default setting of this function is on. Simply by selecting a VRM Voice (page 17), you can enjoy the VRM effect. You can turn the VRM function on or off, and adjust the depth.

Turning the VRM function on or off

While holding down [PIANO/VOICE], press the C0 key repeatedly (if necessary).

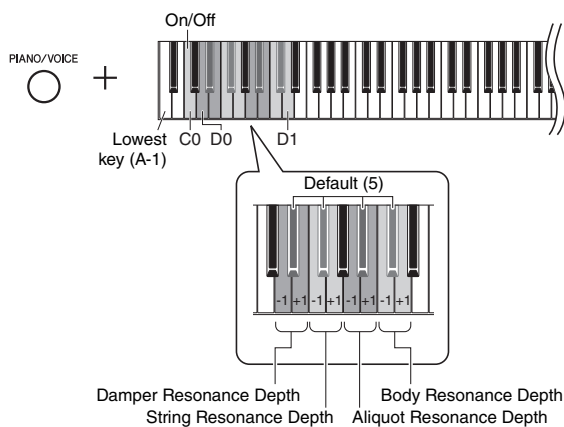

Adjusting the depth of the VRM effect

While holding down [PIANO/VOICE], press one of the keys in the ranges of D0–D1. During the operation, the specified value is shown on the display.

Display	Key	Value	Descriptions
0-10	D0-E0	Damper Resonance Depth	Adjusts the depth of the VRM effect heard when pressing the damper pedal.
0-10	F0-G0	String Resonance Depth	Adjusts the depth of the VRM effect heard when playing the keyboard.
0-10	A0-B0	Aliquot Resonance Depth	Adjusts the sympathetic vibrations of the Aliquot (See below.) resonance effect.
0-10	C1-D1	Body Resonance Depth	Adjust the resonance of the piano itself, i.e. the soundboard, sides, frame and so on.

What is Aliquot?

Aliquot is a stringing method for pianos that uses extra, un-struck strings in the upper octaves to enhance the tone. These strings sympathetically vibrate with other strings in an acoustic piano, resonating with overtones, and adding richness, brilliance and complex color to the sound. Since they do not have damper, they will continue sounding even after you release your hands from the keyboard.

Setting range: 0–10
Default setting: 5

Setting range: 0–10
Default setting: 5

Setting range: 0–10
Default setting: 5

Setting range: 0–10
Default setting: 5

NOTE

The depth of the VRM effect is restored to the default setting when the power is turned off.

Enhancing the Sound with Reverb

The Reverb effect simulates the natural reverberation of a concert hall.

Turning the Reverb on or off

Press [REVERB] repeatedly (if necessary).

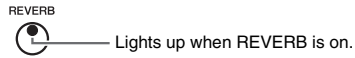

Adjusting the Reverb Depth

While holding down [REVERB], press [+] or [-]. The current value is shown on the display while both controls are held.

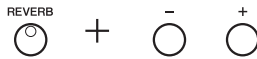

To restore the default value, press [+] and [-] simultaneously while holding [REVERB].

Setting range: 1–20
Default setting: Depends on the selected Voice

NOTE

The Reverb Depth is restored to the default setting when the power is turned off.

NOTE

Holding [REVERB] shows the Reverb Depth value on the display.

Transposing the Pitch in Semitones

You can shift the pitch of the entire keyboard up or down in semitones to facilitate playing in difficult key signatures and match the pitch of the keyboard to the range of a singer or other instruments. For example, if “+5” is selected, playing the key C produces a pitch of F, letting you play a song of F major as though it were in C major.

- **To transpose the pitch down:**

While holding down [FUNCTION], press a key between F#2 (-6) and B2 (-1).

- **To transpose the pitch up:**

While holding down [FUNCTION], press a key between C#3 (+1) and F#3 (+6).

- **To restore the original pitch:**

While holding down [FUNCTION], press the C3 key.

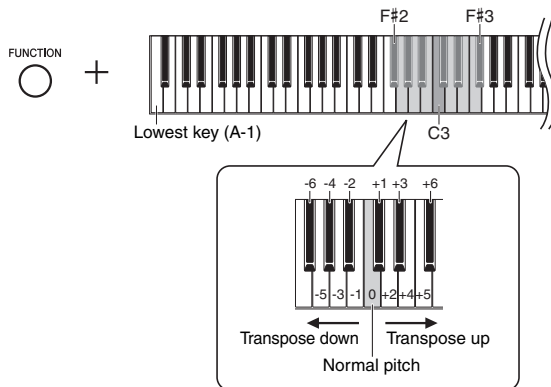

The specified value is shown on the display.

Default setting: 0 (Normal pitch)
Setting range: -6 – +6

NOTE

The Transpose value is restored to the default setting when the power is turned off.

Fine-tuning the Pitch

You can fine-tune the pitch of the entire instrument. This function is useful when you play this instrument along with other instruments or recorded music.

During the operation described below, you can check the Pitch value shown on the display. (The hundreds place value has been omitted.)

42.0

Example: 442.0Hz

- **To tune up (in roughly 0.2Hz steps):**

While holding down [FUNCTION], press [+]. Holding down both buttons shows the current pitch setting (Hz).

- **To tune down (in roughly 0.2Hz steps):**

While holding down [FUNCTION], press [-]. Holding down both buttons shows the current pitch setting (Hz).

- **To restore standard pitch:**

While holding down [FUNCTION], press [+] and [-] simultaneously. Holding down all three buttons shows the current pitch setting (Hz).

NOTE

The tuning value is retained even when the power is turned off.

Hz (Hertz):

This unit of measurement refers to the frequency of a sound and represents the number of times a sound wave vibrates in a second.

Setting range: 414.8–466.8Hz (=A3)
Default setting: 440.0Hz (=A3)

Setting the Scale Tuning

You can select various scales for the instrument. Equal Temperament is the most common contemporary piano tuning scale. However, history has known numerous other scales, many of which serve as the basis for certain genres of music. This feature lets you experience the tunings of these genres.

Selecting a Scale

While holding down [FUNCTION], press one of the C5–F#5 keys. Holding down both controls shows the current value on the display.

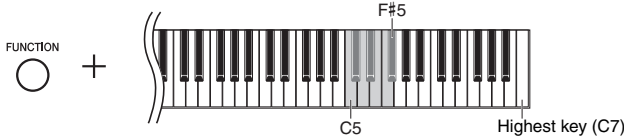

Default setting: 1 (Equal)

NOTE

The scale is restored to the default setting when the power is turned off.

Display	Key	Scale	Description
1	C5	Equal	The pitch range of each octave is divided equally into twelve parts, with each half-step evenly spaced in pitch. This is the most commonly used tuning in music today.
2	C#5	Pure Major	These tunings preserve the pure mathematical intervals of each scale, especially for triad chords (root, third, fifth). You can hear this best in actual vocal harmonies—such as choirs and a cappella singing.
3	D5	Pure Minor	
4	D#5	Pythagorean	This scale was devised by the famous Greek philosopher and is created from a series of perfect fifths, which are collapsed into a single octave. The 3rd in this tuning are slightly unstable, but the 4th and 5th are beautiful and suitable for some leads.
5	E5	Mean-Tone	This scale was created as an improvement on the Pythagorean scale, by making the major third interval more “in tune.” It was especially popular from the 16th century to the 18th century. Handel, among others, used this scale.
6	F5	Werckmeister	This composite scale combines the Werckmeister and Kirnberger systems, which were themselves improvements on the mean-tone and Pythagorean scales. The main feature of this scale is that each key has its own unique character. The scale was used extensively during the time of Bach and Beethoven, and even now it is often used when performing period music on the harpsichord.
7	F#5	Kirnberger	

Selecting the Base Note

For scales 2 and 3 in particular, you should specify the key you intend to play (Base Note). While holding down [FUNCTION], press one of the C4–B4 keys. Holding down both controls shows the current value on the display.

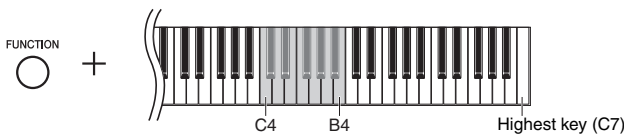

Default setting: C

NOTE

The base note is restored to the default setting when the power is turned off.

Key	Base Note	Key	Base Note	Key	Base Note	Key	Base Note
C4	C	D#4	E♭	F#4	F#	A4	A
C#4	C#	E4	E	G4	G	A#4	B♭
D4	D	F4	F	G#4	A♭	B4	B

Example:

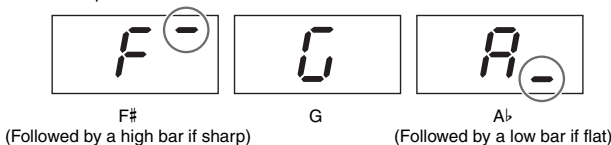

Playing Back Songs

This instrument can play back Songs contained in internal memory or USB flash drive connected to the [USB TO DEVICE] terminal. There are two kinds of Songs that can be played back: MIDI Songs and Audio Songs.

● Song data formats that can be played

Songs	MIDI Songs A MIDI Song contains data of your keyboard performance (such as which keys you played and how hard you played them), and is not a recording of the actual sound itself. The performance information refers to which keys are played, at what timing, and at what strength—just as in a musical score. Based on the recorded performance information, the tone generator (of the digital piano, etc.) outputs the corresponding sound. A MIDI Song uses a small amount of data capacity in comparison to audio recording.	Audio Songs An Audio Song is a recording of the performed sound itself. This data is recorded in the same way as that used in recording cassette tapes, or with voice recorders, etc. This data can be played with a portable music player, etc., allowing you to easily let other people hear your performance.
Data formats	SMF (Standard MIDI File) Formats 0 and 1 One of the most common and widely compatible MIDI formats used for storing sequence data. MIDI Songs recorded in this instrument are saved as SMF Format 0.	WAV format (.wav) Audio file format commonly used by computers. This instrument can play 44.1kHz/16bit stereo WAV files. Audio Songs recorded on this instrument are saved in this format.
Extension	.MID	.WAV

NOTE

When playing back MIDI Songs containing Voices that are incompatible with this instrument such as XG and GM Songs, the Voices may not sound as intended on the original. In addition, Song data of MIDI channels 3–16 cannot be played back, since this instrument can recognize only MIDI channels 1 and 2. This is why you should only play back Songs which have data of only MIDI channels 1–2, to which the piano performance is assigned.

Songs compatible with this instrument

Song Category List (XX indicates numerals.)

Song Category		Song Number	Descriptions
d,XX	Voice Demo Song (MIDI Song)	d0 1–d 15	Each Song effectively demonstrates each of this instrument's Voices (page 18).
P,XX	Preset Song (MIDI Song)	P0 1–P50	50 classical Preset Songs (page 43) permanently stored to the instrument. For information on these Songs, see the music book "50 Classical Music Masterpieces," included with this instrument.
R,XX*	Audio Song in USB flash drive	R00–R99	User Songs which have been recorded with this instrument (page 28)
C,XX*		C00–C99**	External Songs, commercially available or which have been recorded on a computer, etc.
S,XX*	MIDI Song in USB flash drive	S00–S99	User Songs which have been recorded with this instrument (page 28)
F,XX*		F00–F99**	External Songs, commercially available or which have been recorded on a computer, etc.
U,XX	MIDI Song in internal memory of this instrument	U0 1–U 10	User Songs which have been recorded to internal memory of the instrument (page 28)
		L00–L99**	External Songs (commercially available or which have been recorded on a computer, etc.) transferred from a computer to this instrument.

* Shown only when USB flash drive is connected.

** When data does not exist, the Song number is not displayed.

● User Songs and External Songs

Songs recorded by this instrument are called "User Songs" while Songs created in other ways or on other instruments are called "External Songs." In USB flash drive, Songs in the USER FILES folder are handled as User Songs while Songs in a location other than the USER FILES folder are handled as External Songs. When you record a Song to USB flash drive, a USER FILES folder is created automatically and the resulting User Song will be saved in this folder.

Playing Back Songs

To play back a Song on a USB flash drive:

Read "About USB Devices" (page 31), then connect the USB flash drive to the [USB TO DEVICE] terminal, and follow the instructions below.

- 1 While holding down [DEMO/SONG], press [+] to select the desired Song Category (page 25).

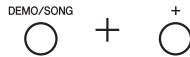

- 2 Press [+] or [-] to select the specific Song number (see "Song Category List" on page 25), or "*.r d" (random) or "*.RL" (all).

- Song numberPlays back only the selected Song.
- *.r dPlays back the Songs of this type continuously in random order.
- *.RLPlays back all the Songs of this type continuously in sequential order.

The asterisk (*) indicates "P", "R", "C", "S", "F" or "U" designation in the display.

- 3 Press [▶/||] (Play/Pause) to start playback.

During playback, the current measure number (for MIDI Songs) or playing time (for Audio Songs) is shown on the display.

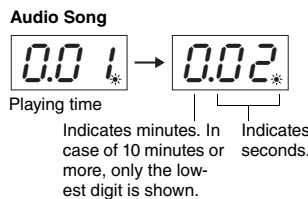
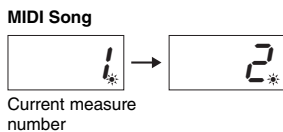

For information on operations such as Pause, Rewind, Fast Forward, etc., refer to "Playback-related Operations" on page 27.

- 4 Press [DEMO/SONG] to stop playback.

If a specific Song number is selected in Step 2, playback stops automatically when the end of the Song is reached.

NOTE

The Song Categories will appear on the display in the following order:
 d.XX → P.XX → (R.XX) → (C.XX) → (S.XX) → (F.XX) → U.XX → d.XX etc.

NOTE

"R.XX", "C.XX", "S.XX" and "F.XX" are shown only when a USB flash drive is connected.

NOTE

Song indications such as "F.DD" and "C.DD" may not appear immediately depending on the amount of the folders in the USB flash drive.

NOTE

This instrument can select or play Songs saved to only the first, second, or third hierarchical folder level. For details, refer to page 32.

NOTE

During playback of a Demo Song, "*.r d" or "*.RL" cannot be selected.

NOTE

- During Demo Song playback, the current measure number is not shown on the display.
- You can play the keyboard along with Song playback.
- The metronome can be used during playback. It will automatically stop when playback is stopped.
- When playing back External Songs on a USB flash drive, actual playback is done in numerical or alphabetical order, according to the Song titles.

Playback-related Operations

Adjusting the tempo (MIDI Song) or playback speed (Audio Song)

You can change the playback tempo of a MIDI Song. You can also adjust the playback speed of an Audio Song during its playback.

While holding down [METRONOME], press [+] / [-] or C#5/B4 key to increase or decrease the value. To reset the value to default, press [+] and [-] simultaneously while holding down [METRONOME]. For details, refer to page 20.

Adjusting the volume (only for Audio Song)

The volume level of this instrument may be markedly different from that of commercially available Audio Song or one recorded on another device. To adjust the volume of the Audio Song, press one of the C1–G2 keys while holding down [DEMO/SONG].

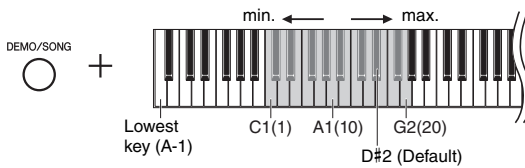

The higher the key, the greater the volume.

Pause

During playback, press [▶/⏸] to pause playback. The display will also pause and the [▶/⏸] lamp will flash. Pressing it again resumes Song playback from the current position.

Rewind/Fast forward

During playback, press [-] or [+] to move back or forth through the measures. Pressing one of these buttons once moves one measure back/forward for MIDI Songs, or one second for Audio Songs.

Returning to the Song Top

During playback, press [-] and [+] simultaneously to jump to the top of the Song.

Setting the Character Code

If the Song cannot be called up, you may need to select the appropriate Character Code from the following two settings.

● International

For playing back Songs with names using western European characters (including umlaut or diacritic marks). To select this, turn on the power while holding down the A-1 and A#-1 keys.

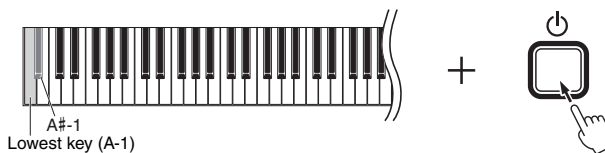

● Japanese

For playing back Songs with names using Japanese characters. To select this, turn on the power while holding down the A-1 and B-1 keys.

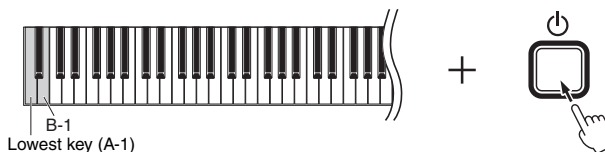

MIDI Song

Setting range: 5 to 500 beats per minute
Default setting: Depends on the selected Song

Audio Song

Setting range: 75% to 125%
Default setting: 100%

Setting range: 1–20

Default setting: 16

NOTE

During playback of a Demo Song, Rewind/Fast Forward operations or returning to the Song top cannot be done.

Setting range: JA (Japanese) / Int (International)

Default setting: Int

Recording Your Performance

This instrument allows you to record your performance by using one of the following two methods. The recorded performance can be played back as a User Song.

● MIDI recording

With this method, your keyboard performances are recorded and saved to internal memory of this instrument or USB flash drive as a MIDI Song (via the SMF format 0). Up to 10 Songs can be recorded to the instrument, although more can be recorded to USB flash drive (See below).

● Audio recording

With this method, your keyboard performances are recorded then saved to USB flash drive as an Audio Song in stereo WAV format of normal CD-quality resolution. The saved Audio Song can be transmitted to then played on portable music players. The recordable time differs depending on the capacity of the USB flash drive.

1 Connect a USB flash drive to the [USB TO DEVICE] terminal.

When is USB flash drive necessary?

MIDI Songs can be saved to internal memory of this instrument or to USB flash drive, while Audio Songs can only be saved to the USB flash drive.

As necessary, prepare a USB flash drive referring to “About USB Devices” (page 31).

NOTE

In case any message appears on the display when connecting the USB flash drive to the instrument, refer to the “Message List” on page 41.

NOTE

If you make an audio recording while using headphones and then play that recorded audio Song through speakers, you should set “Binaural sampling/Stereophonic Optimizer” to “OFF.” Refer to page 15 for details.

NOTE

Songs recorded with the MIDI recording cannot be converted to Audio Songs.

NOTE

Record mode cannot be called up in the following situations.

- During Song playback (page 26)
- During file management operations such as Copy (page 33), Delete (page 30) and Format (page 32)

2 Select the Recording method.

● To make a MIDI Recording:

While holding down [DEMO/SONG], press [+] or [-] until “U**” (for saving data to the instrument) or “S**” (for saving data to the USB flash drive) is shown on the display.

● To make an Audio Recording:

While holding down [DEMO/SONG], press [+] or [-] until “R**” (for saving data to the USB flash drive) is shown on the display.

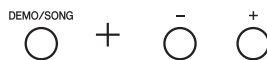

3 Press [+] or [-] to select a Song number.

- **U0 1-U 10** User Song in this instrument (MIDI Song)
- **S00-S99** User Song in USB flash drive (MIDI Song)
- **R00-R99** User Song in USB flash drive (Audio Song)

● When the selected Song contains already-recorded data:

You can confirm it by checking the display.

When Song contains data:



Three dots light up.

When Song does not contain data:



Only the left-most dot lights up.

NOTICE

When the selected Song contains data, keep in mind that recording new data will erase the existing data.

4 Select a Voice (page 17) and other parameters such as Beat (page 19) for recording.

5 Press [REC] to engage the Record mode.

The [REC] lamp lights up, and the [▶/II] (Play/Pause) lamp flashes according to the current tempo.



To exit from the Record mode, press [REC] again.

6 Start recording.

Play a note on the keyboard or press [▶/II] to start recording.

●With MIDI Recording:

While recording, the current measure number is shown on the display.

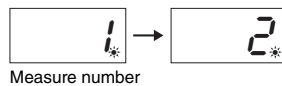

●With Audio Recording:

While recording, the elapsed time is shown on the display.

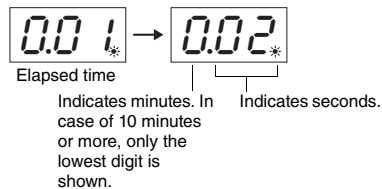

7 Press [REC] or [▶/II] to stop recording.

Dashes appear on the display in succession, indicating that the recorded data is being saved. After the data is saved, an “E n d” message appears for three seconds, indicating that the Record mode is disengaged.

NOTICE

While dashes appear on the display in succession, never turn off the power or disconnect the USB flash drive. Doing so may delete all Song data in the instrument, including external Songs (page 25).

8 Press [▶/II] to play the recorded Song.

To stop playback, press [DEMO/SONG].

Regarding the operations such as Pause or Rewind/Fast forward etc., refer to “Playback-related Operations” on page 27.

Using the Metronome

You can use the metronome while recording, although the metronome sound will not be recorded.

If memory space is running low:

An “E n d” or “F U L” message will appear on the display after pressing [REC]. If “E n d” appears, you can start recording. However, keep in mind that your performance data may not have been correctly saved or recording may stop automatically. If “F U L” appears, you cannot start recording. We recommend that you first remove any unnecessary files (page 30) to ensure sufficient memory capacity.

NOTE

With audio recording, audio signals such as those from the [AUX IN] jack are also recorded.

NOTE

The recorded User Song data on this instrument can be copied to a USB flash drive. Refer to page 33.

When engaging the Record Mode (pressing [REC]) without selecting a Song number

Your performance will be recorded to the selected Song when you press [REC].

NOTICE

When the selected Song contains data, keep in mind that recording new data will erase the existing data.

If one of the following Songs (page 25) is selected, your performance will be recorded to a User Song (page 25) as indicated.

- External audio Song “L .XX” Recorded to “R .XX”.
- External MIDI Song on USB flash drive “F .XX” Recorded to “S .XX”.
- External MIDI Song in internal memory of the instrument “L .XX” Recorded to “U .XX”.
- Voice Demo Song “J .XX”, Preset Song “P .XX” Recorded to “U .XX”.

Then, the Song number as the Recording target will be the lowest Song number (of those containing no data) in each Song category, “R”, “S” and “U”.

If there are no empty User Songs, “R.0.0”, “S.0.0”, or “U.0.1” will be used as the Recording target.

Deleting a Song file

A User Song can be deleted.

- 1 **If necessary, connect the USB flash drive to the [USB TO DEVICE] terminal.**
- 2 **Select the Song to be deleted.**
For details on how to select a Song file, refer to page 26.
- 3 **While holding down [FUNCTION], press [REC].**

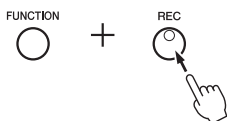

“DEL” appears on the display for a while, then “n 5” appears on the display. If you wish to cancel this operation, press [-].

- 4 **Press [+] to execute the Delete operation.**

Dashes appear in succession on the display, indicating that the Delete operation is in process. When the operation is completed, “END” appears on the display.

NOTICE

While dashes appear in succession on the display, never turn off the power or disconnect the USB flash drive. Doing so may not only corrupt the Song data to be deleted but also other data in the internal memory or the USB flash drive.

NOTE

In case a message appears on the display when connecting a USB flash drive to the instrument, refer to the “Message List” on page 41.

NOTE

Song Playback is not available after executing Step 3. Make sure to confirm the to-be-deleted Song before executing Step 3.

NOTE

The operation here does not apply to Songs transferred from the computer to this instrument's internal memory. If you want to delete such a Song, use a computer.

Using USB Flash Drives

With a USB flash drive plugged in, you can use this instrument to perform the following tasks.

- **Formatting a USB flash drive** page 32
- **Listening to songs stored on the USB flash drive** page 25
- **Recording your performances on the USB flash drive** page 28
- **Copying User Songs recorded on the instrument to the USB flash drive** page 33

NOTE

- When deleting Songs on the USB flash drive, refer to page 30.
- The Format, Copy and Delete operations cannot be done in the following situations.
 - During Song playback (page 26)
 - Record mode (page 29)

About USB Devices

Precautions when using the [USB TO DEVICE] terminal

This instrument features a built-in [USB TO DEVICE] terminal. When connecting a USB device to the terminal, be sure to handle the USB device with care. Follow the important precautions below.

NOTE

For more information about the handling of USB devices, refer to the owner's manual of the USB device.

■ Compatible USB devices

- USB flash drive
- USB hub
- USB wireless LAN adaptor (UD-WL01, which is included only in some areas) (page 38)

Other USB devices such as a USB hub, computer keyboard or mouse cannot be used.

The instrument does not necessarily support all commercially available USB devices. Yamaha cannot guarantee operation of USB devices that you purchase.

Before purchasing a USB device for use with this instrument, please visit the following web page:

<http://download.yamaha.com/>

Although USB devices 2.0 to 3.0 can be used on this instrument, the amount of time for saving to or loading from the USB device may differ depending on the type of data or the status of the instrument. USB 1.1 devices cannot be used on this instrument.

NOTE

The rating of the [USB TO DEVICE] terminal is a maximum of 5V/500mA. Do not connect USB devices having a rating above this, since this can cause damage to the instrument itself.

■ Connecting a USB device

When connecting a USB device to the [USB TO DEVICE] terminal, make sure that the connector on the device is appropriate and that it is connected in the proper direction.

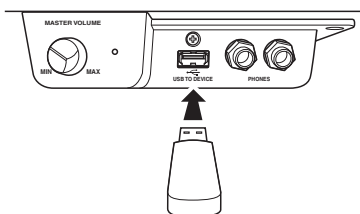

NOTE

- **Avoid connecting or disconnecting the USB device during playback/recording and file management operations (such as Save, Copy, Delete and Format), or when accessing the USB device. Failure to observe this may result in "freezing" of the operation of the instrument or corruption of the USB device and the data.**
- **When connecting then disconnecting the USB device (and vice versa), make sure to wait a few seconds between the two operations.**
- **Do not use an extension cable when connecting a USB device.**

NOTE

If you intend to connect two or three devices at the same time to a terminal, you should use a bus-powered USB hub. Only one USB hub can be used. If an error message appears while using the USB hub, disconnect the hub from the instrument, then turn on the power of the instrument and re-connect the USB hub.

■ Using a USB flash drive

By connecting the instrument to a USB flash drive, you can save data you've created to the connected device, as well as read data from the connected USB flash drive.

● Number of USB flash drives that can be used

Only one USB flash drive can be connected to the [USB TO DEVICE] terminal.

(If necessary, use a USB hub. The number of USB flash drive that can be used simultaneously with musical instruments even when a USB hub is used is only one.)

● Formatting a USB flash drive

You should format the USB flash drive only with this instrument (page 32). A USB flash drive formatted on another device may not operate properly.

NOTE

The format operation overwrites any previously existing data. Make sure that the USB flash drive you are formatting does not contain important data.

● To protect your data (write-protect)

To prevent important data from being inadvertently erased, apply the write-protect provided with each USB flash drive. If you are saving data to the USB flash drive, make sure to disable write-protect.

● Turning off the instrument

When turning off the instrument, make sure that the instrument is NOT accessing the USB flash drive by playback/recording or file management (such as during Save, Copy, Delete and Format operations). Failure to do so may corrupt the USB flash drive and the data.

Formatting USB Flash Drive

NOTICE

Executing the Format operation will delete all data in the USB flash drive. Before formatting, save important data to a computer or another storage device.

- 1 Connect the USB flash drive to the [USB TO DEVICE] terminal.
- 2 While holding [FUNCTION] and [▶/||] (Play/Pause), press [REC].
 “FOr” appears on the display for a while, then “n 5” appears. If you wish to cancel this operation, press [-] here.



NOTE

When you execute a Song Recording (page 29), Copy (page 33) or Delete (page 30) operation, a “UnF” prompt may appear on the display, indicating that the USB flash drive has not been formatted yet. In this case, execute the Format operation by proceeding from Step 2 as described at left.

- 3 Press [+] to execute the Format operation.

Dashes appear in succession on the display, indicating that Formatting is in process. When the operation is completed, “ErD” appears on the display.

NOTICE

While dashes appear in succession on the display, never turn off the power or disconnect the USB flash drive. Doing so may corrupt the data on the USB flash drive, and the Format operation will not be executed properly.

Managing files on a USB flash drive

When organizing files on a USB flash drive using a computer, etc., make sure to place External Songs only in the first, second, or third hierarchical folder level. This instrument will not be able to select or play songs from any level lower than that.

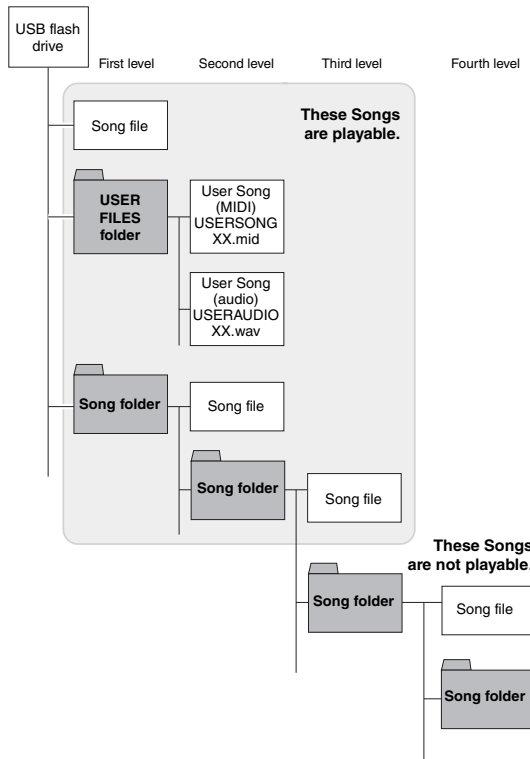

Copying User Songs in the Instrument to USB Flash Drive

You can copy the User Song in the instrument to the USB flash drive. The copied Song is saved as SMF format 0 to the “USER FILES” folder in the USB flash drive, and the file is automatically named as “USERSONG***.MID” (**: numerals).

- 1 **Connect the USB flash drive to the [USB TO DEVICE] terminal.**
- 2 **For the Copy source, select a User Song in this instrument.**
For detailed instructions, refer to page 25.
- 3 **While holding [FUNCTION], press [▶/||] (Play/Pause).**



On the display, “SRU” appears for a while then the Song number (for example “5.00”) appears as Copy destination.

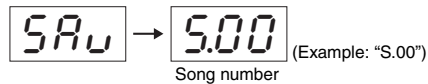

To cancel the Copy operation before it begins, press any button other than [▶/||] here.

- 4 **Press [▶/||] to execute the Copy operation.**
Dashes appears in succession on the display, indicating that the Copy operation is in process. When the Copy is completed, “END” appears on the display.

NOTICE

When dashes appear in succession on the display, never turn off the power or disconnect the USB flash drive. Doing so may corrupt the data on the USB flash drive.

NOTE

If any Song other than one of the User Songs is selected in Step 2, “Prd” appears in Step 3. In this case, return back to Step 2.

NOTE

When there is insufficient free memory capacity in the USB flash drive, the copied Song cannot be saved. To ensure sufficient memory, try erasing unnecessary files (page 30).

Backup Data and Initialization

Backup Data in Internal Memory

The following data, referred to as Backup data, as well as User Song data and External Song data will be maintained even if the power is turned off.

- Character Code page 27
- Tuning page 23
- IAC on/off page 14
- IAC Depth page 14
- Auto Power Off on/off page 13
- Metronome volume page 19
- Audio Song volume page 27
- AUX IN Noise Gate on/off page 36
- Half Pedal Point page 16
- Binaural Sampling / Stereophonic Optimizer on/off page 15
- VRM function on/off page 21
- *Bluetooth* on/off page 39

Initializing the Backup Data

While holding down the C7 key, turn on the power. The Backup data (with the exception of “Character Code”) will be initialized. Note that User Songs and External Songs are not erased.

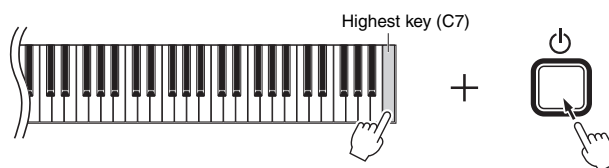

“ \llcorner ” appears on the display, and the initialization starts. When the initialization finishes, the display turns dark.

NOTICE

While the display indicators flash in a pattern (i.e., data is being initialized), never turn off the power. Doing so may delete all Song data in the instrument, including external Songs (page 25), or corrupt the Backup data and cause the Format operation not to be executed properly.

NOTE

If this instrument somehow becomes disabled or malfunctions, turn off the power to the instrument, then perform the initialization procedure.

Connections

⚠ CAUTION

Before connecting the instrument to other electronic components, turn off the power to all the components. Before turning the power on or off to all components, set all volume levels to minimum (0). Otherwise, damage to the components, electrical shock, or even permanent hearing loss may occur.

Jacks and Terminals

Refer to the “Panel Controls and Terminals” on page 10 for information on the location of the jacks and terminals.

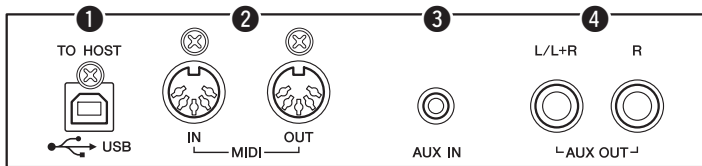

(Left side of the front surface below the keyboard)

- ① [USB TO HOST] terminal page 37
- ② MIDI [IN] [OUT] terminals page 36
- ③ [AUX IN] jack See below.
- ④ AUX OUT [L/L+R] [R] jacks page 36
- ⑤ [USB TO DEVICE] terminal..... page 31

Connecting Audio Devices ([AUX IN] jack, AUX OUT [L/L+R] [R] jacks)

Playing a Portable Audio Player with the Built-in Speakers—[AUX IN] jack

You can connect the headphone jack of a portable audio player to the instrument’s [AUX IN] jack, letting you hear the sound of that audio player through the built-in speakers of the instrument.

NOTICE

To avoid damage to the devices, first turn on the power to the external device, then to the instrument. When turning off the power, first turn off the power to the instrument, then to the external device.

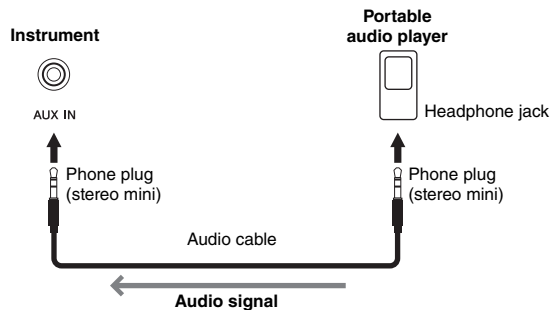

NOTE

Use audio cables and adaptor plugs having no (zero) resistance.

● **Minimizing noise of the input sound via Noise Gate**

By default, this instrument cuts unwanted noise from the input sound. However, this may result in necessary sounds also being cut, such as the soft decay sound of a piano or guitar. To avoid this, set the Noise Gate to off via the following operation.

While holding down [FUNCTION], press the C#6 key repeatedly to toggle Noise Gate on and off as needed.

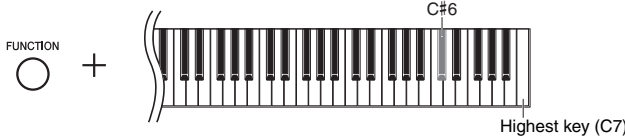

Default setting: On

Using an External Stereo System for Playback—AUX OUT [L/L+R] [R] jacks

These jacks let you connect the instrument to external powered speaker systems, for playing in larger venues at higher volumes.

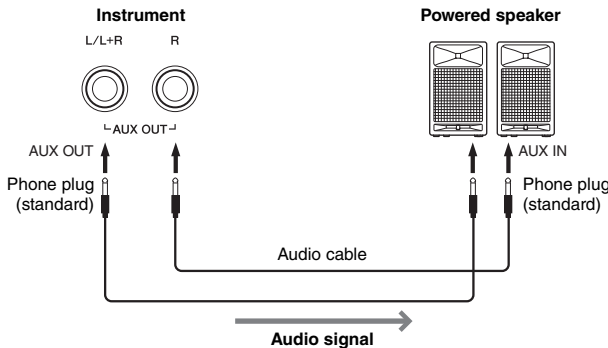

NOTE

Use audio cables and adaptor plugs with no resistance.

NOTE

Use only the AUX OUT [L/L+R] jack for connection with a mono device.

NOTE

If you are monitoring the sound output via the AUX OUT [L/L+R] [R] jacks from headphones connected to the instrument, you should set "Binaural sampling/Stereophonic Optimizer" to "OFF." Refer to page 15 for details.

NOTICE

- To avoid possible damage to the devices, first turn on the power to the instrument, then to the external device. When turning off the power, first turn off the power to the external device, then to the instrument. Since this instrument's power may automatically be turned off due to the Auto Power Off function (page 13), turn off the power to the external device, or disable Auto Power Off when you do not intend to operate the instrument. If the instrument's power is automatically turned off via the Auto Power Off function, first turn off the external device, then turn on the power to the instrument then the external device again.
- When the AUX OUT jacks are connected to an external device, never connect the [AUX IN] jacks to the output jacks of the external device. Doing so could result in feedback (oscillation) that may damage both the devices.

Connecting External MIDI Devices (MIDI [IN] [OUT] terminals)

MIDI (Musical Instrument Digital Interface) is a global format standard for performance data transmission and reception between electronic musical instruments. Connecting musical instruments that support MIDI via MIDI cables enables you to transfer performance and setting data between multiple musical instruments. Using MIDI, you can also achieve more advanced performances than using just a single musical instrument.



NOTE

You need a dedicated MIDI cable to make a MIDI connection.

NOTE

The handled MIDI messages differ depending on the MIDI instrument. In other words, some MIDI messages transmitted from this instrument may not be recognized on a different MIDI instrument. For details, you should check the MIDI Implementation Chart of each MIDI instrument. The MIDI Implementation Chart of this instrument is described in the "MIDI Reference" on the website (page 9).

NOTE

During Song playback, data of only MIDI channels 3–16 will be output via MIDI.

NOTE

Voice Demo Song and Preset Song data are not transmitted via MIDI.

Example for MIDI connection

Example 1:

The connection below allows you to play the sounds of an external MIDI tone generator from the keyboard of this instrument.

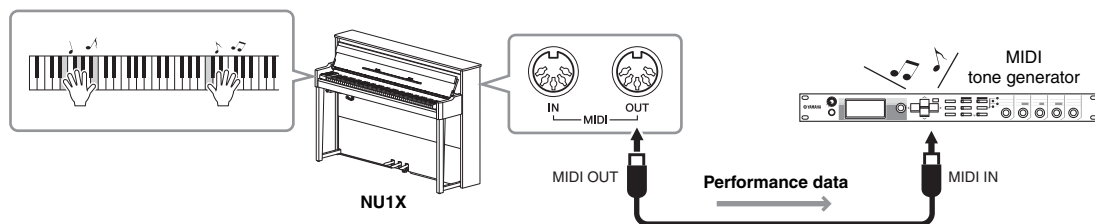

Set the MIDI Receive Channel of the external MIDI tone generator to “1,” since the MIDI Transmit Channel of this instrument is set to “1.”

Example 2:

The connection below allows you to play the sounds of this instrument by playing back a Song on an external MIDI keyboard or sequencer.

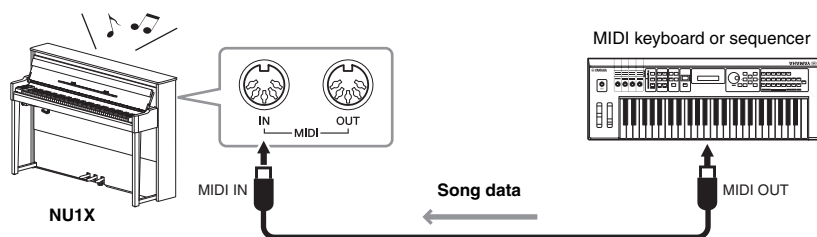

The MIDI Receive Channels of this instrument can only be set to 1 and 2. This is why the data for the piano part should be assigned to MIDI Channels 1 and 2 of the Song.

Local Control on/off

Normally, playing the keyboard will control the internal tone generator. This situation is called “Local Control ON.” If you want to use the keyboard only for controlling an external MIDI instrument, turn off Local Control. With this setting, this instrument will produce no sound even if you play the keyboard.

● To turn the Local Control ON or OFF:

While holding down [FUNCTION], press the C6 key repeatedly (if necessary).



Default setting: On

Connecting to a Computer ([USB TO HOST] terminal)

By connecting a computer to the [USB TO HOST] terminal, you can transfer Song data between the instrument and the computer via MIDI, and take advantage of sophisticated computer music software. For details, refer to the “Computer-related Operations” on the website (page 9).

NOTICE

Use an AB type USB cable of less than 3 meters. USB 3.0 cables cannot be used.

Files that can be transferred from a computer to this instrument (and vice versa).

- Song file: .mid (SMF format 0, 1)

Connecting to a smart device such as iPhone/iPad ([USB TO DEVICE]/ [USB TO HOST], MIDI [IN][OUT] terminals)

You can connect a smart device such as an iPhone or iPad to this instrument via the USB wireless LAN adaptor UD-WL01, or the wireless MIDI adaptor UD-BT01 or MD-BT01 (These adaptors are sold separately and may not be available in some areas.). By using appropriate application tools on your smart device, you can take advantage of convenient functions and get more enjoyment out of this instrument.

For information about the compatible smart devices and application tools, access the Web page of each application tool on the following page:

<http://www.yamaha.com/kbdapps/>

NOTICE

Do not place your smart device such as an iPhone/iPad in an unstable position. Doing so may cause the device to fall and result in damage.

NOTE

- Before using the [USB TO DEVICE] terminal, be sure to read "Precautions when using the [USB TO DEVICE] terminal" on page 31.
- When you use the instrument along with an application on your smart device, such as iPhone/iPad, we recommend that you set your device to not emit radio waves (for example, by setting "Airplane Mode" to "ON").

Connection with the wireless LAN adaptor (UD-WL01*)

*UD-WL01 (sold separately) may not be available depending on your area.

There are two types of connections with the USB wireless adaptor (UD-WL01) described below.

● **Connecting by Access Point Mode**

The Access Point mode allows you to directly connect UD-WL01 (sold separately) and a smart device such as iPhone/iPad, without the need for using an access point. You can use this mode when there is not any access point available for connection to the instrument, or when it is unnecessary to connect to another network while a smart device is connected to the instrument.

- 1 Initialize the instrument (if necessary; see page 34).
- 2 Connect the UD-WL01 (sold separately) to the [USB TO DEVICE] terminal.
- 3 Connect a smart device such as iPhone/iPad to the instrument (as an access point).

● **Connecting by the Infrastructure Mode (Automatic Setup by WPS)**

The Infrastructure mode uses an access point for data communication between a USB wireless LAN adaptor and a network. You can use this mode when you connect to the internet while connecting the wireless LAN adaptor to the instrument.

- 1 Connect the UD-WL01 (sold separately) to the [USB TO DEVICE] terminal.
- 2 Hold down [WPS] on the UD-WL01 for three seconds.
- 3 Press the WPS button on your access point within two minutes after step 2.

Access point

An "access point" refers to a device which acts as a base station when data is transmitted/received via a USB wireless LAN adaptor. Some access points are combined with router or modem functions.

NOTE

When you change the Infrastructure mode (see below) to the Access Point mode, initialize the instrument (page 34).

NOTE

Once you connect by Infrastructure mode, you can connect to a network automatically without executing steps 2 and 3.

Connection with the wireless MIDI adaptor (UD-BT01/MD-BT01*)

*UD-BT01 (sold separately) / MD-BT01(sold separately) may not be available depending on your area.

For details on connections, refer to the "iPhone/iPad Connection Manual" on the website (page 9).

Using the *Bluetooth* audio function

Before using the *Bluetooth* function, be sure to read “About *Bluetooth*” on page 40.

This instrument is equipped with *Bluetooth* functionality. You can input the sound of the audio data saved in a *Bluetooth*-equipped device to this instrument and listen to it through the built-in speaker of the instrument. Also, you can record the input audio data as an Audio Song (page 28).

* *Bluetooth*-equipped device

In this manual, “*Bluetooth*-equipped device” means a device that can transmit the audio data saved in it to the instrument using the *Bluetooth* function via wireless communication; for example, smart phone, digital audio player, etc. For proper operation, the device must be compatible with A2DP (Advanced Audio Distribution Profile).

Pairing with *Bluetooth*-equipped Devices

If you wish to connect your *Bluetooth*-equipped device to the instrument via *Bluetooth*, the device needs to be paired with the instrument first.

Once the *Bluetooth*-equipped device has been paired with this instrument, there is no need to perform pairing again.

1 Hold down [FUNCTION] for 3 seconds.

The instrument will enter into Pairing mode. At the same time the  (*Bluetooth*) lamp will flash and “bt” message will appear on the display. To cancel the pairing, press [▶/||] (Play/Pause).

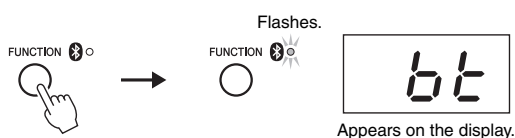

2 On your *Bluetooth*-equipped device, set the *Bluetooth* function to on and select “NU1X” from the connection list.

For details, refer to the *Bluetooth*-equipped device owner’s manual.

After pairing is completed, the  (*Bluetooth*) lamp will light up and the message will disappear and the display will turn dark.

3 Play back audio data on your *Bluetooth*-equipped device to confirm that the built-in speakers of the instrument can output the audio sound.

When you turn on the instrument the next time, the last connected *Bluetooth*-equipped device will be connected to this instrument automatically, if the *Bluetooth* function of the device and the instrument is set to on. If it is not connected automatically, select the model name of the instrument from the connections list on the device.

Pairing

“Pairing” means to register *Bluetooth*-equipped devices on this instrument, and establish the mutual recognition for wireless communication between the two.

NOTE

Only one *Bluetooth*-equipped device can be connected to this instrument at a time (although up to 8 devices can be paired to this instrument). When pairing with the 9th *Bluetooth*-equipped device has succeeded, pairing data for the device with the oldest connection date will be deleted.

NOTE

When the *Bluetooth* function of this instrument is set to “Off,” standby for pairing with the instrument is not enabled when holding [FUNCTION] for 3 seconds. In this case, set *Bluetooth* to “On” (See below.), and then start pairing.

NOTE

- Make sure to complete the settings on the *Bluetooth*-equipped device within 5 minutes. After 5 minutes passed, the Pairing mode ends automatically and the  (*Bluetooth*) lamp turns off.
- If you are required to enter a passkey, enter the numerals “0000.”

NOTE

You can adjust the volume of the sound input via *Bluetooth* by the [MASTER VOLUME] control. To adjust the volume balance between your keyboard performance and the input sound via *Bluetooth*, adjust the volume on the *Bluetooth*-equipped device.

Switching the *Bluetooth* Function On/Off

By default, the *Bluetooth* function will be set to on right after turning the instrument’s power on. However, you can set the function to off when you want to disconnect the connection between the instrument and the *Bluetooth*-equipped device, or when you want to try to connect the device to the instrument again, etc.

While holding down [FUNCTION], press the F6 key repeatedly (if necessary).



About *Bluetooth*

Bluetooth availability

This instrument is equipped with *Bluetooth* functionality; however, even this functionality may not ensure support of *Bluetooth*, depending on the country in which you purchased the product. If the *Bluetooth* logo is printed on the control panel, this means that the product is equipped with *Bluetooth* functionality.

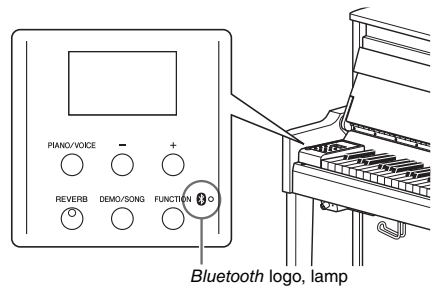

- *Bluetooth* is a technology for wireless communication between devices within an area of about 10 meters (33 ft.) employing the 2.4 GHz frequency band.

Bluetooth®

- The *Bluetooth*® word mark and logos are registered trademarks owned by *Bluetooth* SIG, Inc. and any use of such marks by Yamaha is under license.

■ **Handling *Bluetooth* communications**

- The 2.4 GHz band used by *Bluetooth* compatible devices is a radio band shared by many types of equipment. While *Bluetooth* compatible devices use a technology minimizing the influence of other components using the same radio band, such influence may reduce the speed or distance of communications and in some cases interrupt communications.
- The speed of signal transfer and the distance at which communication is possible differs according to the distance between the communicating devices, the presence of obstacles, radio wave conditions and the type of equipment.
- Yamaha does not guarantee all wireless connections between this unit and devices compatible with *Bluetooth* function.

Message List

Message	Descriptions
<i>bt</i>	The instrument is standing by for <i>Bluetooth</i> pairing. While this message appears, you cannot operate the instrument.
<i>CLR</i>	Displayed when the initialization (page 34) is completed.
<i>con</i>	Displayed when Musicsoft Downloader is started on a computer connected to the instrument. While this message appears, you cannot operate the instrument.
<i>EO1</i>	Displayed when the character code (page 27) is not appropriate for the file name of the Song which you are selecting. Switch the character code.
	Displayed when the data format is not compatible with this instrument, or the data has some other problems. This Song cannot be selected.
	Displayed when no USB flash drive can be found, or a problem has occurred in the USB flash drive. Disconnect and connect the device again, then execute the operation. If this message appears repeatedly even when there aren't any other likely problems, the USB flash drive may be damaged.
	The Song you have selected cannot be copied or deleted on this instrument. Copy or delete these types of Songs on a computer.
<i>EO2</i>	The memory or the number of the files in the copy destination USB flash drive is full. Remove any unnecessary files in the USB flash drive.
<i>EO2</i>	Indicates that the USB flash drive is protected.
<i>EO3</i>	Displayed when the memory of the USB flash drive becomes full, or the number of files and folders exceeds the system limit.
<i>EO4</i>	Displayed when Audio Song playback or recording has failed. If you are using a USB flash drive to which data has already been stored or deleted a number of times, first make sure that the device does not contain important data, then format it (page 32) and connect to the instrument again.
<i>EE1</i>	A malfunction has occurred in the instrument. Contact your nearest Yamaha dealer or authorized distributor.
<i>EEE</i>	A malfunction has occurred in the instrument. Contact your nearest Yamaha dealer or authorized distributor.
<i>End</i>	Displayed when the current operation is completed.
<i>EnP</i>	The memory of the instrument or the USB flash drive is running out. We recommend that you remove any unnecessary files (page 30) to ensure sufficient memory capacity before start recording.
<i>FUL</i>	The operation could not be completed because the instrument's internal memory or the USB flash drive is nearly full. If this message is shown while recording, your performance data may not be correctly saved.
<i>ny</i>	Confirms whether each operation is executed or not.
<i>Pro</i>	Displayed when you try to overwrite or delete a protected Song or read-only file. Use a read-only file after cancelling the read-only setting.
<i>UnF</i>	Displayed when an unformatted USB flash drive is connected. First make sure that the device does not contain important data, then format it (page 32).
<i>Uoc</i>	Communication with the USB flash drive has been shut down because of overcurrent to the USB flash drive. Disconnect the USB flash drive from the [USB TO DEVICE] terminal, then turn on the power of the instrument again.
<i>UU1</i>	Communication with the USB flash drive has failed. Remove the USB flash drive and make the connection again. If the message appears even when the USB flash drive is connected properly, the USB flash drive may be damaged.
<i>UU2</i>	This USB flash drive is not supported on this instrument, or too many USB flash drives may have been connected. Refer to "About USB Devices" (page 31) for information on the USB flash drive connection.
<i>WPS</i>	The instrument is in Access Point mode and standing by for connection to an access point by WPS (page 38). While this message appears, you cannot operate the instrument.
<i>WPS.</i>	A malfunction occurred in the instrument while it was standing by for connection to an access point by WPS (page 38). Reconnect the UD-WL01 (sold separately) to the instrument and try to connect to the access point by WPS again.

* When an operation (such as saving or data transfer) is in process, the display shows a sequence of flashing dashes.

* Press any button to exit from these message displays.

Troubleshooting

Problem	Possible Cause and Solution
The instrument does not turn on.	The instrument has not been plugged in properly. Securely insert the female plug into the socket on the instrument, and the male plug into a proper AC outlet (page 12).
A click or pop is heard when the power is turned on or off.	Electrical current is being applied to the instrument. This is normal.
The power is automatically turned off.	This is normal and due to the Auto Power Off function. If necessary, set the parameter of the Auto Power Off function (page 13).
Noise is heard from the instrument's speakers or headphones.	The noise may be due to interference caused by the use of a mobile phone in close proximity to the instrument. Turn off the mobile phone, or use it further away from the instrument. Noise can be heard when you use the instrument along with the application on your smart device, such as an iPad, iPhone, or iPod touch. We recommend that you set your device to not emit radio waves (for example, by setting "Airplane Mode" to "ON") in order to avoid noise caused by communication.
The overall volume is low, or no sound is heard.	The volume is set too low: set it to an appropriate level using the [MASTER VOLUME] control (page 14). Make sure a pair of headphones is not connected to the [PHONES] jack (page 15). Make sure that Local Control (page 37) is on.
The pitch and/or tone of the Piano Voices in certain ranges do not sound right.	The Piano Voices attempt to precisely simulate actual piano sounds. However, as a result of sampling algorithms, overtones in some ranges may sound exaggerated, producing a somewhat different pitch or tone. This is normal, and no cause for concern.
Sound is not heard on a particular key.	Keyboard may not function normally if the key was pressed when the power was turned on. Turn off the power and turn it on again to reset the function. Do not touch any keys when turning the power on (page 12).
Mechanical noise is heard during performance.	This is normal. The keyboard mechanism of this instrument is the same as that of an actual piano, which also has mechanical noise.
When playing the same key repeatedly and quickly or playing a trill continuously for a long time, a sound louder than expected (considering your playing strength) might very occasionally occur.	This might be caused by the mechanical structure of the keys and the action; this is normal, but only very seldom occurs.
The key you pressed does not return to the original position smoothly.	Since the keyboard mechanism of this instrument is the same as that of an actual piano, the mechanism may change over years of use. If this occurs or causes problems in performance, contact your Yamaha dealer.
Some keys sound louder or quieter than other keys.	
Sound input to the [AUX IN] jacks is interrupted.	The output volume of the external device connected to this instrument is too low, resulting in the sound being cut off via the Noise Gate after it is input to this instrument. <ul style="list-style-type: none"> • Increase the output volume of the external device. The volume level reproduced via this instrument's speakers can be adjusted by using the [MASTER VOLUME] control. • Set the Noise Gate to off (page 36).
The USB flash drive has hung up (stopped).	Disconnect the USB flash drive and connect it to the instrument again. The USB flash drive is not compatible with the instrument. Only use the USB flash drive whose compatibility has been confirmed by Yamaha (page 31).
Higher or lower notes do not sound correctly when the transpose setting is made.	The instrument can cover the range of C-2–G8 when you set the transposition. If notes lower than C-2 are played, the actual resulting sound is one octave higher. If notes higher than G8 are played, the resulting sound is one octave lower.
The Bluetooth-equipped device cannot be paired with nor connected to this instrument.	The Bluetooth function of the instrument is off; make sure that it is turned on (page 39). The Bluetooth-equipped device is not paired with this instrument. The device and this instrument need to be paired to each other via Bluetooth (page 39). The Bluetooth function of the Bluetooth-equipped device is not activated. Make sure that the function is activated. This instrument and the Bluetooth-equipped device are too far apart. Use the device in close proximity to this instrument. There is a device (microwave oven, wireless LAN device, etc.) that outputs signals in the 2.4 GHz frequency band nearby. Move the instrument away from any devices that might be emitting radio-frequency signals.
Sound input via Bluetooth is interrupted.	The output volume of the Bluetooth-equipped device connected to this instrument is too low, resulting in the sound being cut off via the Noise Gate after it is input to this instrument. Increase the output volume of the device. The volume level reproduced via this instrument's speakers can be adjusted by using the [MASTER VOLUME] control.

* The message list (page 41) is also provided for your reference.

Preset Song List

(50 Classical Music Masterpieces)

Display	Song Name	Composer
Arrangements		
P.01	Canon D dur	J. Pachelbel
P.02	Air On the G Strings	J. S. Bach
P.03	Jesus, Joy of Man's Desiring	J. S. Bach
P.04	Twinkle, Twinkle, Little Star	Traditional
P.05	Piano Sonate op.31-2 "Tempest" 3rd mov.	L. v. Beethoven
P.06	Ode to Joy	L. v. Beethoven
P.07	Wiegenlied op.98-2	F. P. Schubert
P.08	Grande Valse Brillante	F. F. Chopin
P.09	Polonaise op.53 "Héroïque"	F. F. Chopin
P.10	La Campanella	F. Liszt
P.11	Salut d'amour op.12	E. Elgar
P.12	From the New World	A. Dvořák
P.13	Sicilienne	G. U. Fauré
P.14	Clair de lune	C. A. Debussy
P.15	Jupiter (The Planets)	G. Holst
Duets		
P.16	Menuett (Eine kleine Nachtmusik K.525)	W. A. Mozart
P.17	Menuett G dur	L. v. Beethoven
P.18	Marcia alla Turca	L. v. Beethoven
P.19	Piano Concerto No.1 op.11 2nd mov.	F. F. Chopin
P.20	The Nutcracker Medley	P. I. Tchaikovsky
Original Compositions		
P.21	Prelude (Wohltemperierte Klavier I No.1)	J. S. Bach
P.22	Menuett G dur BWV Anh.114	J. S. Bach
P.23	Piano Sonate No.15 K.545 1st mov.	W. A. Mozart
P.24	Turkish March	W. A. Mozart
P.25	Piano Sonate op.13 "Pathétique" 2nd mov.	L. v. Beethoven
P.26	Für Elise	L. v. Beethoven
P.27	Piano Sonate op.27-2 "Mondschein" 1st mov.	L. v. Beethoven
P.28	Impromptu op.90-2	F. P. Schubert
P.29	Frühlingslied op.62-6	J. L. F. Mendelssohn
P.30	Fantaisie-Impromptu	F. F. Chopin
P.31	Etude op.10-3 "Chanson de l'adieu"	F. F. Chopin
P.32	Etude op.10-12 "Revolutionary"	F. F. Chopin
P.33	Valse op.64-1 "Petit chien"	F. F. Chopin
P.34	Nocturne op.9-2	F. F. Chopin
P.35	Nocturne KK4a-16/BI 49 [Posth.]	F. F. Chopin
P.36	Träumerei	R. Schumann
P.37	Barcarolle	P. I. Tchaikovsky
P.38	La prière d'une Vierge	T. Badarzewska
P.39	Liebesträume No.3	F. Liszt
P.40	Blumenlied	G. Lange
P.41	Humoresque	A. Dvořák
P.42	Arietta	E. H. Grieg
P.43	Tango (España)	I. Albéniz
P.44	The Entertainer	S. Joplin
P.45	Maple Leaf Rag	S. Joplin
P.46	La Fille aux Cheveux de Lin	C. A. Debussy
P.47	Arabesque No.1	C. A. Debussy
P.48	Cakewalk	C. A. Debussy
P.49	Je te veux	E. Satie
P.50	Gymnopédies No.1	E. Satie

Specifications

Product Name		Hybrid Piano	
Size/Weight	Width	1,501 mm (59-1/8")	
	Height	1,024 mm (40-5/16")	
	Depth	463 mm (18-1/4")	
	Weight	111 kg (244 lbs, 11 oz)	
Control Interface	Keyboard	Number of Keys	88 (A-1 – C7)
		Key Surfaces - White	Acrylic resin
		Touch Response	Hard/Medium/Soft/Fixed
	Sensor System	Key Sensors	Non-contact optical fiber
	Pedal	Number of Pedals	3
		Functions	Damper (with half-pedal effect), Sostenuto, Soft
Type		GP Responsive Damper Pedal	
Cabinet	Fallboard	Soft-Close Fallboard	Yes
	Music Rest		Yes
Voices	Tone Generation	Piano Sound	Yamaha CFX, Bösendorfer Imperial
		Binaural Sampling	Yes (CFX Grand Voice only)
	Piano Effect	VRM	Yes
		Key-off Samples	Yes
		Smooth Release	Yes
	Polyphony (max.)		256
Preset	Number of Voices	15	
Effects	Types	Reverb	Yes
		Intelligent Acoustic Control (IAC)	Yes
		Stereophonic Optimizer	Yes
Songs (MIDI)	Preset	Number of Preset Songs	15 Voice Demo Songs + 50 Classics
	Recording	Number of Songs	10
		Number of Tracks	1
		Data Capacity	approx. 500 KB/Song
	Format	Playback	SMF (Format 0, Format 1)
		Recording	SMF (Format 0)
Recording/ Playback (Audio)	Recording Time (max.)		80 minutes/Song
	Format	Playback	WAV (44.1 kHz, 16 bit, stereo)
		Recording	WAV (44.1 kHz, 16 bit, stereo)
Functions	Overall Controls	Metronome	Yes
		Tempo Range	5 – 500
		Transpose	-6 – 0 – +6
		Tuning	414.8 – 440.0 – 466.8 Hz (approx. 0.2 Hz increments)
		Scale Type	7 Types
	<i>Bluetooth</i> (May not have this functionality depending on the country in which you purchased the product.)	<i>Bluetooth</i> version	4.1
		Supported profile	A2DP
		Compatible codec	SBC
		Wireless output	<i>Bluetooth</i> class 2
		Maximum communication distance	Approx. 10 m (33 ft)
		Range of transmit frequency	2,402 – 2,480 MHz
		Maximum RF output Power	4 dBm
Storage and Connectivity	Storage	Internal Memory	Total maximum size approx. 1.5 MB
		External Drives	USB flash drive
	Connectivity	Headphones	Standard stereo phone jack (x 2)
		MIDI	IN/OUT
		AUX IN	Stereo Mini
		AUX OUT	[L/L+R] [R] (Standard phone jack)
		USB TO DEVICE	Yes
		USB TO HOST	Yes
Sound System	Amplifiers	(45 W + 45 W) x 2	
	Speakers	(16 cm + 1.9 cm) x 2	
	Acoustic Optimizer	Yes	
Power Supply	Auto Power Off	Yes	
Included Accessories		Owner's Manual (this book), Power cord, Felt key cover, Bench*, Online Member Product Registration, Felt strip set, "50 Classical Music Masterpieces" Music Book * May not be included depending on your area. Check with your dealer.	
Separately Sold Accessories (May not be available depending on your area.)		Headphones (HPH-50/HPH-100/HPH-150) USB wireless LAN adaptor (UD-WL01) Wireless MIDI Adaptor (UD-BT01/MD-BT01)	

* The contents of this manual apply to the latest specifications as of the publishing date. To obtain the latest manual, access the Yamaha website then download the manual file. Since specifications, equipment or separately sold accessories may not be the same in every locale, please check with your Yamaha dealer.

Index

Numerics

50 Classical Music Masterpieces ..43

A

Access Point Mode38
Access point38
Accessories9
Aliquot Resonance21
Audio recording28
Audio Song25
Auto Power Off13
AUX IN35
AUX OUT36

B

Backup34
Base Note24
Beat19
Binaural Sampling15
Bluetooth39, 40
Body Resonance21

C

Character Code27
Computer37
Computer-related Operations9
Connection35
Control Panel10
Copy33

D

Damper Resonance21
Data format25
Delete30
Demo Song18
Demo Song List18
Display10

E

External Song25

F

Fallboard11
Fast forward27
Format (USB Flash Drive)32

H

Half Pedal Point16
Half-pedal16

Headphone hanger15
Headphones15
Hz (Hertz)23

I

Infrastructure Mode38
Initialization34
Installing7
Intelligent Acoustic Control (IAC) ..14
iPhone/iPad38
iPhone/iPad Connection Manual ...9

L

Local Control37

M

Maintenance6
Master Volume14
Message List41
Metronome19
MIDI36, 38
MIDI Basics9
MIDI recording28
MIDI Reference9
MIDI Song25
Music Rest11

N

Noise Gate36

P

Pairing39
Pause27
Pedal16
Playback
 all26
 Audio Song26
 Demo Song18
 MIDI Song26
 Preset Song26
 random26
Playback speed (Audio Song) ...27
Power12
PRECAUTIONS5
Preset Song List43

Q

Quick Operation Guide46

R

Recording28
Reverb22
Rewind27

S

Scale24
Smart device38
Song25
Song Category List25
Specifications44
Stereophonic Optimizer15
String Resonance21

T

Tempo20
Tempo (MIDI Song)27
Touch Sensitivity20
Transporting7
Transpose23
Troubleshooting42
Tuning7, 23

U

USB Device31
USB Flash Drive31
USB hub31
USB TO DEVICE31, 35, 38
USB TO HOST37, 38
USB wireless LAN adaptor ..31, 38
User Song25

V

Version13
Virtual Resonance Modeling ...21
Voice17
Voice Demo Song18
Voice List17
Volume (Audio Song)27
Volume (Master Volume)14
Volume (Metronome volume) ..19
VRM21

W

Wireless LAN38
Wireless MIDI adaptor38

Quick Operation Guide

While holding down the button on the control panel, press one of the corresponding keys's shown below to set parameters.

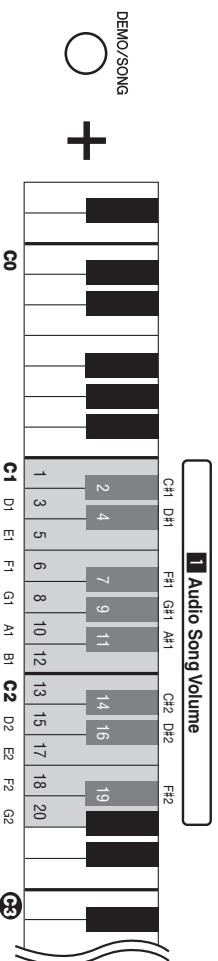

1 Audio Song Volume	(page 27)	12 Tempo	(page 20)
2 VRM	(page 21)	13 IAC	(page 14)
3 Damper Resonance Depth	(page 21)	14 IAC Depth	(page 14)
4 String Resonance Depth	(page 21)	15 Transpose	(page 23)
5 Aliquot Resonance Depth	(page 21)	16 Base Note	(page 24)
6 Body Resonance Depth	(page 21)	17 Scale	(page 24)
7 Half Pedal Point	(page 16)	18 Auto Power Off function	(page 13)
8 Binaural Sampling/ Stereophonic Optimizer	(page 15)	19 Version	(page 13)
9 Touch Sensitivity	(page 20)	20 Local Control	(page 37)
10 Metronome Volume	(page 19)	21 AUX IN Noise Gate	(page 36)
11 Metronome Beat	(page 19)	22 Bluetooth Pairing	(page 39)
		23 Bluetooth Function	(page 39)

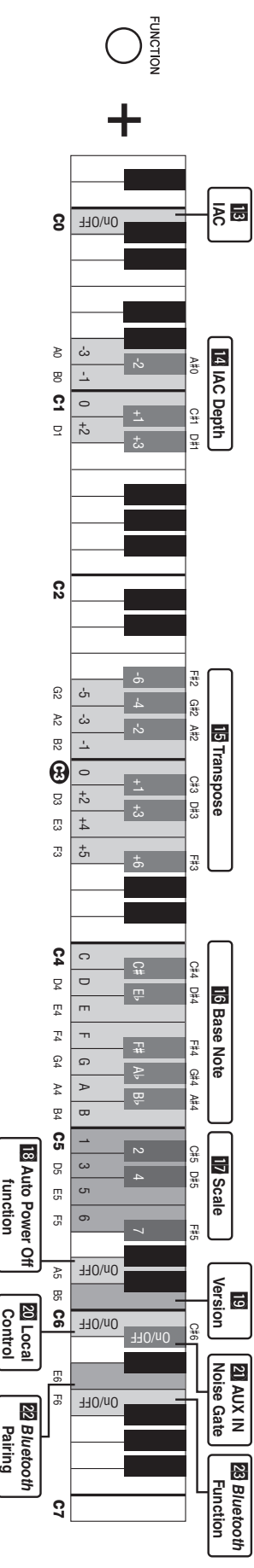
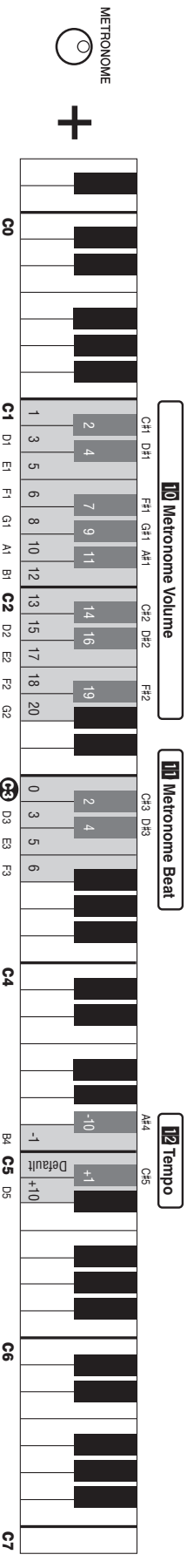
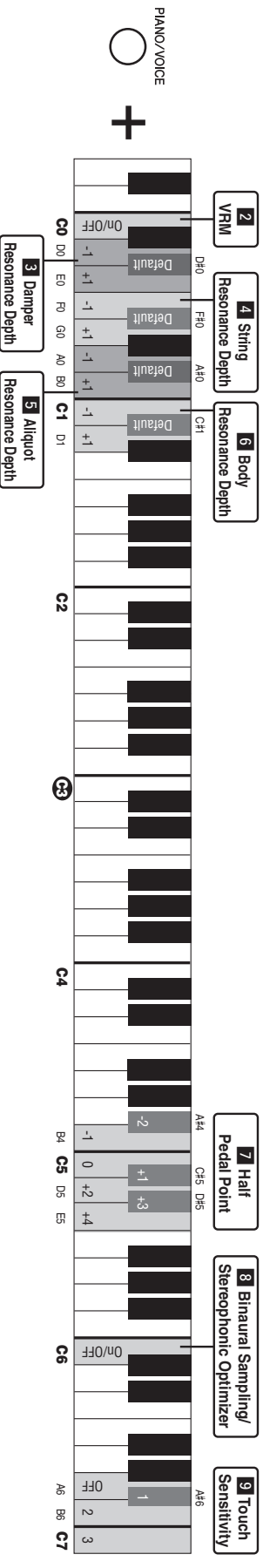

FUNCTION
+

METRONOME
+

PIANO/VOICE
+

DEMO/SONG
+

18 Auto Power Off function

20 Local Control

22 Bluetooth Pairing

19 Version

21 AUX IN Noise Gate

23 Bluetooth Function

Information for users on collection and disposal of old equipment:



This symbol on the products, packaging, and/or accompanying documents means that used electrical and electronic products should not be mixed with general household waste.

For proper treatment, recovery and recycling of old products, please take them to applicable collection points, in accordance with your national legislation.

By disposing of these products correctly, you will help to save valuable resources and prevent any potential negative effects on human health and the environment which could otherwise arise from inappropriate waste handling.

For more information about collection and recycling of old products, please contact your local municipality, your waste disposal service or the point of sale where you purchased the items.

For business users in the European Union:

If you wish to discard electrical and electronic equipment, please contact your dealer or supplier for further information.

Information on Disposal in other Countries outside the European Union:

This symbol is only valid in the European Union. If you wish to discard these items, please contact your local authorities or dealer and ask for the correct method of disposal.

(weee_eu_en_02)

For U.S.A.

This transmitter must not be co-located or operated in conjunction with any other antenna or transmitter.

For CANADA

This device complies with Industry Canada licence-exempt RSS standard(s). Operation is subject to the following two conditions: (1) this device may not cause interference, and (2) this device must accept any interference, including interference that may cause undesired operation of the device.

Le présent appareil est conforme aux CNR d'Industrie Canada applicables aux appareils radio exempts de licence. L'exploitation est autorisée aux deux conditions suivantes : (1) l'appareil ne doit pas produire de brouillage, et (2) l'utilisateur de l'appareil doit accepter tout brouillage radioélectrique subi, même si le brouillage est susceptible d'en compromettre le fonctionnement.

For U.S.A. and CANADA

This equipment complies with FCC/IC radiation exposure limits set forth for an uncontrolled environment and meets the FCC radio frequency (RF) Exposure Guidelines and RSS-102 of the IC radio frequency (RF) Exposure rules. This equipment has very low levels of RF energy that are deemed to comply without testing of specific absorption rate (SAR).

Cet équipement est conforme aux limites d'exposition aux rayonnements énoncées pour un environnement non contrôlé et respecte les règles des radioélectriques (RF) de la FCC lignes directrices d'exposition et d'exposition aux fréquences radioélectriques (RF) CNR-102 de l'IC. Cet équipement émet une énergie RF très faible qui est considérée conforme sans évaluation du débit d'absorption spécifique (DAS).

For EU countries

BG Bulgarian

ОПРОСТЕНА ЕС ДЕКЛАРАЦИЯ ЗА СЪОТВЕТСТВИЕ

С настоящото Yamaha Music Europe GmbH декларира, че този тип радиосъоръжение [NU1X] е в съответствие с Директива 2014/53/ЕС. Цялостният текст на ЕС декларацията за съответствие може да се намери на следния интернет адрес: <https://europe.yamaha.com/en/support/compliance/doc.html>

ES Spanish

DECLARACIÓN UE DE CONFORMIDAD SIMPLIFICADA

Por la presente, Yamaha Music Europe GmbH declara que el tipo de equipo radio-eléctrico [NU1X] es conforme con la Directiva 2014/53/UE. El texto completo de la declaración UE de conformidad está disponible en la dirección Internet siguiente: <https://europe.yamaha.com/en/support/compliance/doc.html>

CS Czech

ZJEDNODUŠENÉ EU PROHLÁŠENÍ O SHODĚ

Tímto Yamaha Music Europe GmbH prohlašuje, že typ rádiového zařízení [NU1X] je v souladu se směrnicí 2014/53/EU. Úplné znění EU prohlášení o shodě je k dispozici na této internetové adrese: <https://europe.yamaha.com/en/support/compliance/doc.html>

DA Danish

FORENKLET EU-OVERENSSTEMMELSESERKLÆRING

Herved erklærer Yamaha Music Europe GmbH, at radioudstyrstypen [NU1X] er i overensstemmelse med direktiv 2014/53/EU. EU-overensstemmelseserklæringens fulde tekst kan findes på følgende internetadresse: <https://europe.yamaha.com/en/support/compliance/doc.html>

DE German

VEREINFACHTE EU-KONFORMITÄTSERKLÄRUNG

Hiermit erklärt Yamaha Music Europe GmbH, dass der Funkanlagentyp [NU1X] der Richtlinie 2014/53/EU entspricht. Der vollständige Text der EU-Konformitätserklärung ist unter der folgenden Internetadresse verfügbar: <https://europe.yamaha.com/en/support/compliance/doc.html>

ET Estonian

LIHTSUSTATUD ELI VASTAVUSDEKLARATSIOON

Käesolevaga deklareerib Yamaha Music Europe GmbH, et käesolev raadioseadme tüüp [NU1X] vastab direktiivi 2014/53/EL nõuetele. ELi vastavusdeklaratsiooni täielik tekst on kättesaadav järgmisel internetiaadressil: <https://europe.yamaha.com/en/support/compliance/doc.html>

EL Greek

ΑΠΛΟΥΣΤΕΥΜΕΝΗ ΔΗΛΩΣΗ ΣΥΜΜΟΡΦΩΣΗΣ ΕΕ

Με την παρούσα ο/η Yamaha Music Europe GmbH, δηλώνει ότι ο ραδιοεξοπλισμός [NU1X] πληροί την οδηγία 2014/53/ΕΕ. Το πλήρες κείμενο της δήλωσης συμμόρφωσης ΕΕ διατίθεται στην ακόλουθη ιστοσελίδα στο διαδίκτυο: <https://europe.yamaha.com/en/support/compliance/doc.html>

EN English

SIMPLIFIED EU DECLARATION OF CONFORMITY

Hereby, Yamaha Music Europe GmbH declares that the radio equipment type [NU1X] is in compliance with Directive 2014/53/EU. The full text of the EU declaration of conformity is available at the following internet address: <https://europe.yamaha.com/en/support/compliance/doc.html>

FR French

DECLARATION UE DE CONFORMITE SIMPLIFIEE

Le soussigné, Yamaha Music Europe GmbH, déclare que l'équipement radioélectrique du type [NU1X] est conforme à la directive 2014/53/UE. Le texte complet de la déclaration UE de conformité est disponible à l'adresse internet suivante: <https://europe.yamaha.com/en/support/compliance/doc.html>

HR Croatian

POJEDNOSTAVLJENA EU IZJAVA O SUKLADNOSTI

Yamaha Music Europe GmbH ovime izjavljuje da je radijska oprema tipa [NU1X] u skladu s Direktivom 2014/53/EU. Cjeloviti tekst EU izjave o sukladnosti dostupan je na sljedećoj internetskoj adresi: <https://europe.yamaha.com/en/support/compliance/doc.html>

IT Italian

DICHIARAZIONE DI CONFORMITÀ UE SEMPLIFICATA

Il fabbricante, Yamaha Music Europe GmbH, dichiara che il tipo di apparecchiatura radio [NU1X] è conforme alla direttiva 2014/53/UE. Il testo completo della dichiarazione di conformità UE è disponibile al seguente indirizzo Internet: <https://europe.yamaha.com/en/support/compliance/doc.html>

LV Latvian

VIENTKĀRŠOTA ES ATBILSTĪBAS DEKLARĀCIJA

Ar šo Yamaha Music Europe GmbH deklarē, ka radioiekārta [NU1X] atbilst Direktīvai 2014/53/ES. Pilns ES atbilstības deklarācijas teksts ir pieejams šādā interneta vietnē: <https://europe.yamaha.com/en/support/compliance/doc.html>

LT Lithuanian

SUPAPRASTINTA ES ATITIKTIES DEKLARACIJA

Aš, Yamaha Music Europe GmbH, patvirtinu, kad radijo įrenginių tipas [NU1X] atitinka Direktyvą 2014/53/ES. Visas ES atitikties deklaracijos tekstas prieinamas šiuo interneto adresu: <https://europe.yamaha.com/en/support/compliance/doc.html>

HU Hungarian

EGYSZERŰSÍTETT EU-MEGFELELŐSÉGI NYILATKOZAT

Yamaha Music Europe GmbH igazolja, hogy a [NU1X] típusú rádióberendezés megfelel a 2014/53/EU irányelvnek. Az EU-megfelelőségi nyilatkozat teljes szövege elérhető a következő internetes címen: <https://europe.yamaha.com/en/support/compliance/doc.html>

NL Dutch

VEREENVOUDIGDE EU-CONFORMITEITSVERKLARING

Hierbij verklaar ik, Yamaha Music Europe GmbH, dat het type radioapparatuur [NU1X] conform is met Richtlijn 2014/53/EU. De volledige tekst van de EU-conformiteitsverklaring kan worden geraadpleegd op het volgende internetadres: <https://europe.yamaha.com/en/support/compliance/doc.html>

PL Polish

UPROSZCZONA DEKLARACJA ZGODNOŚCI UE

Yamaha Music Europe GmbH niniejszym oświadcza, że typ urządzenia radiowego [NU1X] jest zgodny z dyrektywą 2014/53/UE. Pełny tekst deklaracji zgodności UE jest dostępny pod następującym adresem internetowym: <https://europe.yamaha.com/en/support/compliance/doc.html>

PT Portuguese

DECLARAÇÃO UE DE CONFORMIDADE SIMPLIFICADA

O(a) abaixo assinado(a) Yamaha Music Europe GmbH declara que o presente tipo de equipamento de rádio [NU1X] está em conformidade com a Diretiva 2014/53/UE. O texto integral da declaração de conformidade está disponível no seguinte endereço de Internet: <https://europe.yamaha.com/en/support/compliance/doc.html>

RO Romanian

DECLARAȚIA UE DE CONFORMITATE SIMPLIFICATĂ

Prin prezenta, Yamaha Music Europe GmbH declară că tipul de echipamente radio [NU1X] este în conformitate cu Directiva 2014/53/UE. Textul integral al declarației UE de conformitate este disponibil la următoarea adresă internet: <https://europe.yamaha.com/en/support/compliance/doc.html>

SK Slovak

ZJEDNODUŠENÉ EÚ VYHLÁSENIE O ZHODE

Yamaha Music Europe GmbH týmto vyhlasuje, že rádiové zariadenie typu [NU1X] je v súlade so smernicou 2014/53/EÚ. Úplné EÚ vyhlásenie o zhode je k dispozícii na tejto internetovej adrese: <https://europe.yamaha.com/en/support/compliance/doc.html>

SL Slovenian

POENOSTAVLJENA IZJAVA EU O SKLADNOSTI

Yamaha Music Europe GmbH potrjuje, da je tip radijske opreme [NU1X] skladen z Direktivo 2014/53/EU. Celotno besedilo izjave EU o skladnosti je na voljo na naslednjem spletnem naslovu: <https://europe.yamaha.com/en/support/compliance/doc.html>

FI Finnish

YKSINKERTAISTETTU EU-VAATIMUSTENMUKAISUUSVAKUUTUS

Yamaha Music Europe GmbH vakuuttaa, että radiolaitetyyppi [NU1X] on direktiivin 2014/53/EU mukainen. EU-vaatimustenmukaisuusvakuutuksen täysimittainen teksti on saatavilla seuraavassa internetosoitteessa: <https://europe.yamaha.com/en/support/compliance/doc.html>

SV Swedish

FÖRENKLAD EU-FÖRSÄKRAN OM ÖVERENSSTÄMMELSE

Härmed försäkrar Yamaha Music Europe GmbH att denna typ av radioutrustning [NU1X] överensstämmer med direktiv 2014/53/EU. Den fullständiga texten till EU-försäkran om överensstämmelse finns på följande webbadress: <https://europe.yamaha.com/en/support/compliance/doc.html>

TR Turkey

BASİTLEŞTİRİLMİŞ AVRUPA BİRLİĞİ UYGUNLUK BİLDİRİMİ

İşbu belge ile, Yamaha Music Europe GmbH, radyo cihaz tipinin [NU1X], Direktif 2014/53/AB'ye uygunluğunu beyan eder. AB uyumu beyanının tam metni aşağıdaki internet adresinden edinilebilir: <https://europe.yamaha.com/en/support/compliance/doc.html>



Important Notice: Guarantee Information for customers in European Economic Area (EEA) and Switzerland

Important Notice: Guarantee Information for customers in EEA* and Switzerland For detailed guarantee information about this Yamaha product, and Pan-EEA* and Switzerland warranty service, please either visit the website address below (Printable file is available at our website) or contact the Yamaha representative office for your country. * EEA: European Economic Area	English
Wichtiger Hinweis: Garantie-Information für Kunden in der EWR* und der Schweiz Für nähere Garantie-Information über dieses Produkt von Yamaha, sowie über den Pan-EWR*- und Schweizer Garantieservice, besuchen Sie bitte entweder die folgende angegebene Internetadresse (eine druckfähige Version befindet sich auch auf unserer Webseite), oder wenden Sie sich an den für Ihr Land zuständigen Yamaha-Vertrieb. *EWR: Europäischer Wirtschaftsraum	Deutsch
Remarque importante: informations de garantie pour les clients de l'EEE et la Suisse Pour des informations plus détaillées sur la garantie de ce produit Yamaha et sur le service de garantie applicable dans l'ensemble de l'EEE ainsi qu'en Suisse, consultez notre site Web à l'adresse ci-dessous (le fichier imprimable est disponible sur notre site Web) ou contactez directement Yamaha dans votre pays de résidence. * EEE : Espace Economique Européen	Français
Belangrijke mededeling: Garantie-informatie voor klanten in de EER* en Zwitserland Voor gedetailleerde garantie-informatie over dit Yamaha-product en de garantieservice in heel de EER* en Zwitserland, gaat u naar de onderstaande website (u vindt een afdrukbare bestand op onze website) of neemt u contact op met de vertegenwoordiging van Yamaha in uw land. * EER: Europese Economische Ruimte	Nederlands
Aviso importante: información sobre la garantía para los clientes del EEE* y Suiza Para una información detallada sobre este producto Yamaha y sobre el soporte de garantía en la zona EEE* y Suiza, visite la dirección web que se incluye más abajo (la versión del archivo para imprimir está disponible en nuestro sitio web) o póngase en contacto con el representante de Yamaha en su país. * EEE: Espacio Económico Europeo	Español
Aviso importante: informazioni sulla garanzia per i clienti residenti nell'EEA* e in Svizzera Per informazioni dettagliate sulla garanzia relativa a questo prodotto Yamaha e l'assistenza in garanzia nei paesi EEA* e in Svizzera, potete consultare il sito Web all'indirizzo riportato di seguito (è disponibile il file in formato stampabile) oppure contattare l'ufficio di rappresentanza locale della Yamaha. * EEA: Area Economica Europea	Italiano
Aviso importante: informações sobre as garantias para clientes da AEE* e da Suíça Para obter uma informação pormenorizada sobre este produto da Yamaha e sobre o serviço de garantia na AEE* e na Suíça, visite o site a seguir (o arquivo para impressão está disponível no nosso site) ou entre em contato com o escritório de representação da Yamaha no seu país. * AEE: Área Económica Europeia	Português
Σημαντική σημείωση: Πληροφορίες εγγύησης για τους πελάτες στον ΕΟΧ* και Ελλάδα Για λεπτομερείς πληροφορίες εγγύησης σχετικά με το παρόν προϊόν της Yamaha και την κάλυψη εγγύησης σε όλο το χώρο του ΕΟΧ* και την Ελλάδα, επισκεφτείτε την παρακάτω ιστοσελίδα (Εκτυρίσιμη μορφή είναι διαθέσιμη στην ιστοσελίδα μας) ή απευθυνθείτε στην αντιπροσωπεία της Yamaha στη χώρα σας. * ΕΟΧ: Ευρωπαϊκό Οικονομικό Χώρο	Ελληνικά
Viktig: Garantiinformasjon for kunder i EES-området* och Schweiz För detaljerad information om denna Yamaha-produkt samt garantireservice i hela EES-området* och Schweiz kan du antingen besöka nedanstående webbadress (en utskriftsvärdig fil finns på webbplatsen) eller kontakta Yamahas officiella representant i ditt land. *EES: Europeiska Ekonomiska Samarbetsområdet	Svenska
Viktig merknad: Garantiinformasjon for kunder i EØS* og Sveits Detaljert informasjon om dette Yamaha-produktet og garantireservice for hele EØS-området* og Sveits kan fås enten ved å besøke nettstedene nedenfor (utskriftsversion finnes på våre nettsider) eller kontakte Yamahas kontoret i landet der du bor. *EØS: Det europeiske økonomiske samarbeidsområdet	Norsk
Viktig oplysning: Garantioplysninger til kunder i EØO* og Schweiz De kan finne detaljerte garantioplysninger om dette Yamaha-produkt og den fælles garantireserviceordning for EØO* (og Schweiz) ved at besøge det websted, der er angivet nedenfor (der findes en fil, som kan udskrives, på vores websted), eller ved at kontakte Yamahas nationale repræsentationskontor i det land, hvor De bor. * EØO: Det Europæiske Økonomiske Område	Dansk

Tärkeä ilmoitus: Taku tiedot Euroopan talousalueen (ETA)* ja Sveitsin asiakkaille Tämän Yamaha-tuotteen sekä ETA-alueen ja Sveitsin takuuta koskevat yksityiskohtaiset tiedot saatte alla olevasta netti-sivustosta. (Tulostettava tiedosto saatavissa sivustollamme.) Voititte myös ottaa yhteyttä paikalliseen Yamaha-edustajaan. *ETA: Euroopan talousalue	Suomi
Ważne: Warunki gwarancji i informacje obowiązujące w EOG* i Szwajcarii Aby dowiedzieć się więcej na temat warunków gwarancyjnych tego produktu firmy Yamaha i serwisu gwarancyjnego w całym EOG* i Szwajcarii, należy odwiedzić wskazaną poniżej stronę internetową (plik gotowy do wydruku znajduje się na naszej stronie internetowej) lub skontaktować się z przedstawicielstwem firmy Yamaha w swoim kraju. * EOG — Europejski Obszar Gospodarczy	Polski
Důležité oznámení: Záruční informace pro zákazníky v EHS* a ve Švýcarsku Podrobné záruční informace o tomto produktu Yamaha a záručním servisu v celém EHS* a ve Švýcarsku naleznete na níže uvedené webové adrese (soubor k tisku je dostupný na našich webových stránkách) nebo se můžete obrátit na zastoupení firmy Yamaha ve své zemi. * EHS: Evropský hospodářský prostor	Česky
Fontos figyelmeztetés: Garancia-információk az EGT* területén és Svájcban élő vásárlók számára A jelen Yamaha termékre vonatkozó részletes garancia-információk, valamint az EGT*-re és Svájcra kiterjedő garanciális szolgáltatás tekintetében keressék fel a webhelyünkön az alábbi címen (a webhelyen nyomtatható fájl is talál), vagy pedig lépjen kapcsolatba az országában működő Yamaha képviselői iróddal. * EGT: Európai Gazdasági Térség	Magyar
Ouline märkeus: Garantiteave Euroopa Majanduspiirkonna (EMP)* ja Šveitsi klientidele Täpsemat teabete saamiseks selle Yamaha toote garantii ning kogu Euroopa Majanduspiirkonna ja Šveitsi garantiteeninduse kohta, külastage palun veebisaiti alljärgneval aadressil (meie saidil on saadaval printitav fail) või pöörduge Teie regiooni Yamaha esinduse poole. * EMP: Euroopa Majanduspiirkond	Eesti keel
Svarīgs paziņojums: garantijas informācija klientiem EEZ* un Šveicē Lai saņemtu detalizētāku garantijas informāciju par šo Yamaha produktu, kā arī garantijas apkalpošanu EEZ* un Šveicē, lūdzam apmeklēt vietni, kurā norādīts tālruna numurs vai e-pasts, vai arī iet uz vietni, kurā ir norādīts adreses un tālruna numurs. * EEZ: Eiropas Ekonomikas zona	Latviešu
Dėmesio: informacija dėl garantijos pirkėjams EEE* ir Šveicarijoje Jei reikia išsamesios informacijos apie šį „Yamaha“ produktą ir jo techninę priežiūrą visoje EEE* ir Šveicarijoje, apsilankykite mūsų svetainėje toliau nurodytu adresu (svetainėje yra spausdinamas failas) arba kreipkitės į „Yamaha“ atstovybę savo šalyje. *EEE – Europos ekonominė erdvė	Lietuvių kalba
Dôležité upozornenie: Informácie o záruke pre zákazníkov v EHP* a Švajčiarsku Podrobnejšie informácie o záruke týkajúcej sa tohto produktu od spoločnosti Yamaha a garanciou servisu v EHP* a Švajčiarsku nájdete na webovej stránke uvedenej nižšie (na našej webovej stránke je k dispozícii súbor na tlač) alebo sa obráťte na zástupcu spoločnosti Yamaha vo svojej krajine. * EHP: Európsky hospodársky priestor	Slovenčina
Pomembno obvestilo: Informacije o garanciji za kupce v EGP* in Švici Za podrobnejše informacije o tem Yamahinem izdelku ter garancijskem servisu v celotnem EGP in Švici, obiščite spletno mesto, ki je navedeno spodaj (nesljajiva datoteka je na voljo na našem spletnem mestu), ali se obrnite na Yamahinega predstavnika v svoji državi. * EGP: Evropski gospodarski prostor	Slovenščina
Важно съобщение: Информация за гаранцията за клиенти в ЕИП* и Швейцария За подробна информация за гаранцията за този продукт на Yamaha и гаранционното обслужване в панаевропейската зона на ЕИП* и Швейцария или посетете посочения по-долу сайт (на нашия уеб сайт има файл за печат), или се свържете с представителния офис на Yamaha във вашата страна. * ЕИП: Европейско икономическо пространство	Български език
Notificarea importantă: Informații despre garanție pentru clienții din SEE* și Elveția Pentru informații detaliate privind acest produs Yamaha și serviciul de garanție Pan-SEE* și Elveția, vizitați site-ul la adresa de mai jos (fișierul imprimabil este disponibil pe site-ul nostru) sau contactați biroul reprezentanței Yamaha din țara dumneavoastră. * SEE: Spațiul Economic European	Limba română

<http://europe.yamaha.com/warranty/>

For details of products, please contact your nearest Yamaha representative or the authorized distributor listed below.

Para detalles sobre productos, contacte su tienda Yamaha más cercana o el distribuidor autorizado que se lista debajo.

Pour plus de détails sur les produits, veuillez-vous adresser à Yamaha ou au distributeur le plus proche de vous figurant dans la liste suivante.

NORTH AMERICA

CANADA

Yamaha Canada Music Ltd.
135 Milner Avenue, Toronto, Ontario M1S 3R1,
Canada
Tel: +1-416-298-1311

U.S.A.

Yamaha Corporation of America
6600 Orangethorpe Avenue, Buena Park, CA 90620,
U.S.A.
Tel: +1-714-522-9011

CENTRAL & SOUTH AMERICA

MEXICO

Yamaha de México, S.A. de C.V.
Av. Insurgentes Sur 1647 Piso 9, Col. San José
Insurgentes, Delegación Benito Juárez, México,
D.F., C.P. 03900, México
Tel: +52-55-5804-0600

BRAZIL

Yamaha Musical do Brasil Ltda.
Rua Fidêncio Ramos, 302 – Cj 52 e 54 – Torre B –
Vila Olímpia – CEP 04551-010 – São Paulo/SP,
Brazil
Tel: +55-11-3704-1377

ARGENTINA

**Yamaha Music Latin America, S.A.,
Sucursal Argentina**
Olga Cossetini 1553, Piso 4 Norte,
Madero Este-C1107CEK,
Buenos Aires, Argentina
Tel: +54-11-4119-7000

PANAMA AND OTHER LATIN AMERICAN COUNTRIES/ CARIBBEAN COUNTRIES

Yamaha Music Latin America, S.A.
Edif. Torre Banco General, F7, Urb. Marbella,
Calle 47 y Aquilino de la Guardia, Panama,
P.O.Box 0823-05863, Panama, Rep.de Panama
Tel: +507-269-5311

EUROPE

THE UNITED KINGDOM/IRELAND

Yamaha Music Europe GmbH (UK)
Sherbourne Drive, Tilbrook, Milton Keynes,
MK7 8BL, U.K.
Tel: +44-1908-366700

GERMANY

Yamaha Music Europe GmbH
Siemensstrasse 22-34, 25462 Rellingen, Germany
Tel: +49-4101-303-0

SWITZERLAND/LIECHTENSTEIN

**Yamaha Music Europe GmbH, Branch
Switzerland in Thalwil**
Seestrasse 18a, 8800 Thalwil, Switzerland
Tel: +41-44-3878080

AUSTRIA/CROATIA/CZECH REPUBLIC/ HUNGARY/ROMANIA/SLOVAKIA/ SLOVENIA

Yamaha Music Europe GmbH, Branch Austria
Schleiergasse 20, 1100 Wien, Austria
Tel: +43-1-60203900

POLAND

Yamaha Music Europe GmbH
Sp.z o.o. Oddział w Polsce
ul. Wielicka 52, 02-657 Warszawa, Poland
Tel: +48-22-880-08-88

BULGARIA

Dinacord Bulgaria LTD.
Bul.Iskarsko Schose 7 Targowski Zentar Ewropa
1528 Sofia, Bulgaria
Tel: +359-2-978-20-25

MALTA

Olimpus Music Ltd.
Valletta Road, Mosta MST9010, Malta
Tel: +356-2133-2093

NETHERLANDS/BELGIUM/ LUXEMBOURG

Yamaha Music Europe, Branch Benelux
Clarissenhof 5b, 4133 AB Vianen, The Netherlands
Tel: +31-347-358040

FRANCE

Yamaha Music Europe
7 rue Ambroise Croizat, Zone d'activités de Pariest,
77183 Croissy-Beaubourg, France
Tel: +33-1-6461-4000

ITALY

Yamaha Music Europe GmbH, Branch Italy
Via Tinelli N.67/69 20855 Gerno di Lesmo (MB),
Italy
Tel: +39-039-9065-1

SPAIN/PORTUGAL

**Yamaha Music Europe GmbH Ibérica, Sucursal
en España**
Ctra. de la Coruna km. 17,200, 28231
Las Rozas de Madrid, Spain
Tel: +34-91-639-88-88

GREECE

Philippos Nakas S.A. The Music House
19th km. Leof. Lavriou 190 02 Peania – Attiki,
Greece
Tel: +30-210-6686260

SWEDEN

**Yamaha Music Europe GmbH Germany filial
Scandinavia**
JA Wettergrensgata 1, 400 43 Göteborg, Sweden
Tel: +46-31-89-34-00

DENMARK

**Yamaha Music Denmark,
Filial of Yamaha Music Europe GmbH, Tyskland**
Generatorvej 8C, ST. TH., 2860 Soborg, Denmark
Tel: +45-44-92-49-00

FINLAND

F-Musiikki Oy
Antaksentie 4
FI-01510 Vantaa, Finland
Tel: +358 (0)96185111

NORWAY

**Yamaha Music Europe GmbH Germany -
Norwegian Branch**
Grini Næringspark 1, 1332 Østerås, Norway
Tel: +47-6716-7800

ICELAND

Hljóðfaerahúsid Ehf.
Sidumula 20
IS-108 Reykjavik, Iceland
Tel: +354-525-5050

RUSSIA

Yamaha Music (Russia) LLC.
Room 37, entrance 7, bld. 7, Kievskaya street,
Moscow, 121059, Russia
Tel: +7-495-626-5005

OTHER EUROPEAN COUNTRIES

Yamaha Music Europe GmbH
Siemensstrasse 22-34, 25462 Rellingen, Germany
Tel: +49-4101-303-0

AFRICA

Yamaha Music Gulf FZE
JAFZA-16, Office 512, P.O.Box 17328,
Jebel Ali FZE, Dubai, UAE
Tel: +971-4-801-1500

MIDDLE EAST

TURKEY

Yamaha Music Europe GmbH
Merkezi Almanya Türkiye Istanbul Şubesi
Maslak Meydanı Sokak, Spring Giz Plaza Bagimsiz
Böl. No:3, Sarıyer İstanbul, Turkey
Tel: +90-212-999-8010

CYPRUS

Nakas Music Cyprus Ltd.
Nikis Ave 2k
1086 Nicosia
Tel: + 357-22-511080
Major Music Center
21 Ali Riza Ave. Ortakoy
P.O.Box 475 Nicosia, Cyprus
Tel: (392) 227 9213

OTHER COUNTRIES

Yamaha Music Gulf FZE
JAFZA-16, Office 512, P.O.Box 17328,
Jebel Ali FZE, Dubai, UAE
Tel: +971-4-801-1500

ASIA

THE PEOPLE'S REPUBLIC OF CHINA

Yamaha Music & Electronics (China) Co., Ltd.
2F, Yunhedasha, 1818 Xinzha-lu, Jingan-qu,
Shanghai, China
Tel: +86-400-051-7700

HONG KONG

Tom Lee Music Co., Ltd.
11/F., Silvercord Tower 1, 30 Canton Road,
Tsimshatsui, Kowloon, Hong Kong
Tel: +852-2737-7688

INDIA

Yamaha Music India Private Limited
P-401, JMD Megapolis, Sector-48, Sohna Road,
Gurgaon-122018, Haryana, India
Tel: +91-124-485-3300

INDONESIA

PT. Yamaha Musik Indonesia (Distributor)
Yamaha Music Center Bldg. Jalan Jend. Gatot
Subroto Kav. 4, Jakarta 12930, Indonesia
Tel: +62-21-520-2577

KOREA

Yamaha Music Korea Ltd.
8F, Dongsung Bldg. 21, Teheran-ro 87-gil,
Gangnam-gu, Seoul, 06169, Korea
Tel: +82-2-3467-3300

MALAYSIA

Yamaha Music (Malaysia) Sdn. Bhd.
No.8, Jalan Perbandaran, Kelana Jaya, 47301
Petaling Jaya, Selangor, Malaysia
Tel: +60-3-78030900

SINGAPORE

Yamaha Music (Asia) Private Limited
Block 202 Hougang Street 21, #02-00,
Singapore 530202, Singapore
Tel: +65-6740-9200

TAIWAN

Yamaha Music & Electronics Taiwan Co., Ltd.
2F., No.1, Yuandong Rd., Banqiao Dist.,
New Taipei City 22063, Taiwan (R.O.C.)
Tel: +886-2-7741-8888

THAILAND

Siam Music Yamaha Co., Ltd.
3, 4, 15, 16th Fl., Siam Motors Building,
891/1 Rama 1 Road, Wangmai,
Pathumwan, Bangkok 10330, Thailand
Tel: +66-2215-2622

VIETNAM

Yamaha Music Vietnam Company Limited
15th Floor, Nam A Bank Tower, 201-203 Cach
Mang Thang Tam St., Ward 4, Dist.3,
Ho Chi Minh City, Vietnam
Tel: +84-8-3818-1122

OTHER ASIAN COUNTRIES

<http://asia.yamaha.com>

OCEANIA

AUSTRALIA

Yamaha Music Australia Pty. Ltd.
Level 1, 80 Market Street, South Melbourne,
VIC 3205 Australia
Tel: +61-3-9693-5111

NEW ZEALAND

Musik Works LTD
P.O.Box 6246 Wellesley, Auckland 4680,
New Zealand
Tel: +64-9-634-0099

COUNTRIES AND TRUST TERRITORIES IN PACIFIC OCEAN

<http://asia.yamaha.com>

Yamaha Global Site
<https://www.yamaha.com/>

Yamaha Downloads
<http://download.yamaha.com/>

Manual Development Group
© 2017 Yamaha Corporation

Published 07/2017 POSC* *- **A0
Printed in China

ZW14240