

A Console-format Powered Mixer for Advanced Live Applications

More sources? Bigger venues? If your sound reinforcement requirements are getting serious, but you still want the convenience and reliable performance of a Yamaha powered mixer, check out the console-style EMX5014C. Here's an all-in-one solution that will appeal to bands and venue operators alike. The EMX5014C transports and sets up with the ease of systems built around the smaller EMX-series powered mixers, but will also prove it's worth in more permanent installations. It can even be rack-mounted for vertical or angled operation, and real space savings! But of course the EMX5014C offers much more than just convenience. It provides a surprising palette of features and versatile signal routing options that can take your live sound to the next level. And it's a Yamaha, so you know it's going to sound great.

EMX5014C POWERED MIXER

Up To 8 Mics, 14 Inputs Total

4 Stereo inputs

500 W + 500 W (4Ω)

3-band Mid-sweep Channel EQ

9-band Stereo Graphic EQ

One-knob Compression

FCL System

SPX Digital Effects

Dual AUX Sends

Input Gain Trim

Comprehensive I/O

PFL and AFL Monitoring

Power Select Switch

Standby Mode

Power Amp Mode Switch

YAMAHA Speaker Processing

Lightweight Design

Rack Mountable

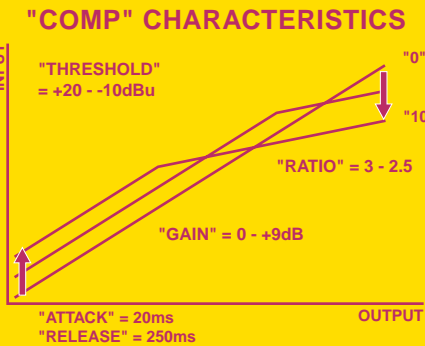
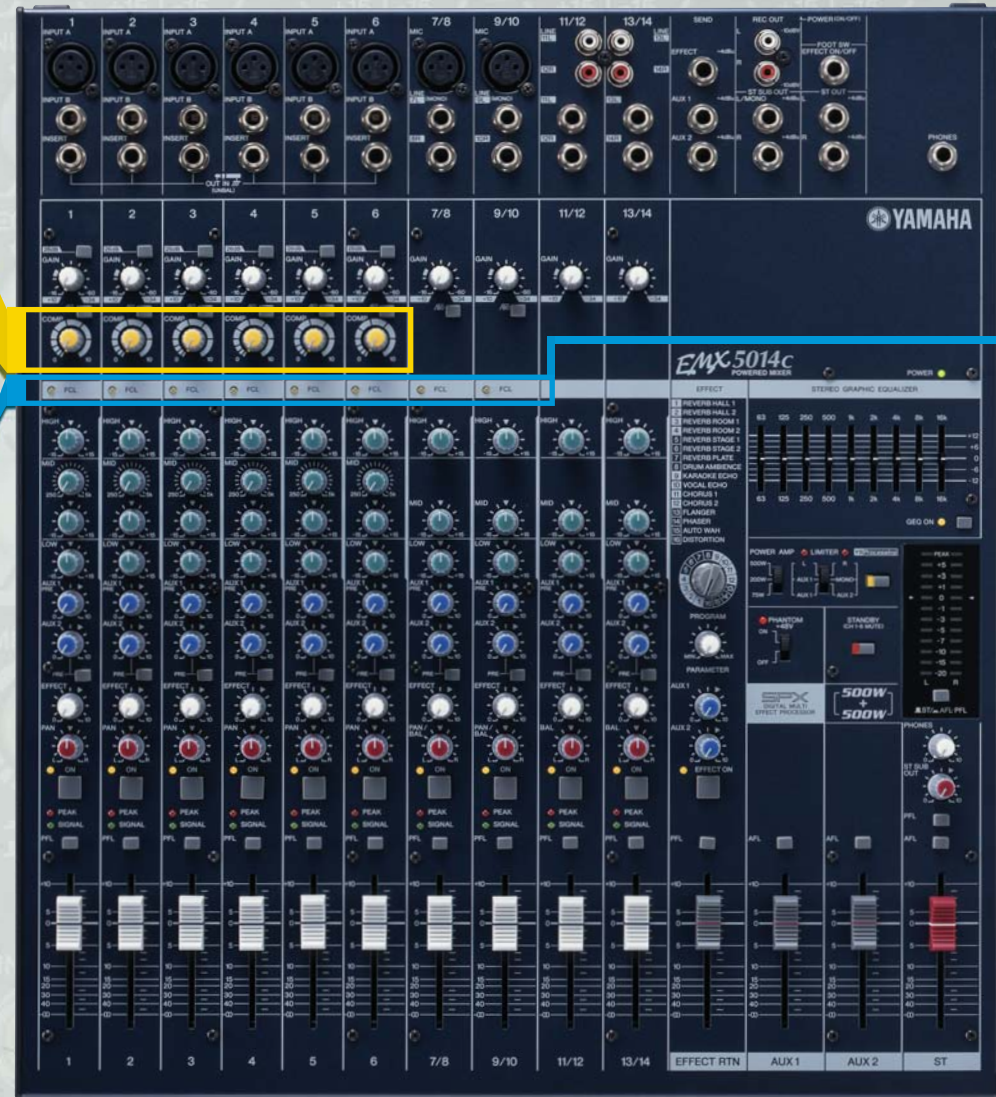

Console Controllability and Versatility

With the many features and control functions provided by the EMX5014C, console style is the only way to go. It's still compact enough to be placed in the stage area and controlled by the performers – especially if rack mounted – but its console configuration also makes it an ideal choice for front-of-house type operation by a sound engineer. Linear faders are another advantage of the console layout, providing precise level control as well as graphic representation of relative channel levels.

Expanded EQ Capability

Like the other EMX-series mixers, the EMX5014C features 3-band EQ on all input channels, but goes a step further on the six mono channels with mid-frequency sweep controls. The mid EQ center frequency can be continuously swept from 250 Hz through 5 kHz so you can precisely pinpoint frequencies in the critical midrange that require compensation or enhancement, providing significantly greater enhanced tailoring potential. The stereo graphic equalizer has also been expanded with 9 bands that can be used for more effective room voicing or feedback control.

One-knob Compression on Mono Channels

Built-in channel dynamics is normally a feature reserved for much larger (and more expensive) mixers. But in the EMX5014C you get compressors on all six monaural mic/line channels. Judicious application of compression can help to make vocals ride the mix better, give you that smooth compressed guitar sound, deliver more punchy bass, and generally refine your mixes in a multitude of ways. Yamaha's unique one-knob compressors are simple to use, too. There's no need to juggle multiple attack, threshold, makeup gain, and other controls – just set the COMP control to the amount of compression you need.

Feedback Channel Locating (FCL) System

FCL System indicator LEDs at the top of each channel light if the corresponding channel goes into feedback. So if and when feedback occurs you'll be able to locate the channel(s) in which it is occurring immediately and rectify the problem without delay.

Versatile 14-Input Configuration

The EMX5014C has a total of 14 input channels – six for monaural microphone or line input, plus four stereo pairs. Two of the stereo channels can function either as monaural microphone inputs or stereo line inputs. Switchable phantom power is provided for all microphone inputs. This system lets you use up to eight microphone channels plus two stereo inputs if your sources are mostly microphones. Or if you need to handle more stereo sources – say, Background Music, from a DJ mixer, and two stereo keyboards – the EMX5014C will comfortably handle all of these in addition to six monaural microphone or line inputs.

Comprehensive I/O

Although the EMX5014C and a pair of speakers or two are all you need to create a powerful, high-performance live sound system, it features a range of inputs and outputs that allow it to be integrated into larger systems. Insert patch points on the mono input channels, for example, let you add outboard signal processing to individual input channels. And although you have all the effects you're likely to need built in, and monitor power, external AUX and EFFECT sends allow you to route the mixer's signals to external signal processing and/or monitor systems as required. Stereo out, stereo sub-out, and record outputs are also provided.

SPX Digital Effects

Normally you'll only need ambience effects such as reverb and delay for live sound applications – and the EMX5014C includes some of the finest reverb and delay effects available built right in – but if you need other effects as well they're right at your fingertips. You can dial up a selection of 16 top-quality Yamaha SPX effects – including reverb, echo, chorus, flanger, phaser, and even distortion. Yamaha SPX digital effects are widely recognized as being some of the finest available, and the effects provided in the EMX mixers live up to that reputation.

Dual AUX Sends

AUX 1 and AUX 2 send controls, with pre/post fader switching for AUX 2, adjust the level of the channel signal sent to the auxiliary buses for monitoring or effects send. The availability of two AUX sends provides considerable flexibility for effect and monitor routing. You could, for example, use the channel EFFECT controls to control send level to the internal SPX effect processor while using AUX 2 to feed an external effects unit, and AUX 1 to feed a stage monitor system.

Yamaha Speaker Processing

You'll undoubtedly want to use at least one pair of Yamaha Club-series speakers with the EMX5014C for the superior sound and projection they provide. If you do you'll really appreciate the enhanced low-end output and high-end smoothness provided by built-in Yamaha speaker processing.

Rack Mountable

With the optional RK5014 rack-mount kit, the EMX5014C can be conveniently mounted in a portable or installed rack. This has been made possible by a combination of the mixer's configuration and a highly efficient fan cooling system that ensures reliable, stable operation.

Other Pro-class Features

- Gain controls and 26-dB pad switches allow optimum level matching with just about any source.
- 80-Hz high pass filters for elimination of unwanted low-frequency noise and rumble.
- Channel ON switches let you switch individual channels into or out of the mix.
- Pan control adjusts the position of mono channel signals in the stereo sound field, while balance controls on stereo channels control the balance of the stereo image.
- High-quality linear faders individually adjust the level of each channel.
- PFL (pre-fader listen) switches allow isolated monitoring of individual channels.
- All input channels feature signal and peak indicators for visual signal monitoring.
- Linear AUX 1, AUX 2, and EFFECT RTN faders with AFL (after-fader listen) monitor switches.
- Stereo master fader with both PFL and AFL monitor switches.
- Limiter indicators tell you when the internal limiter circuitry has been activated due to power amplifier overload.
- Power Amp mode selector allows two-channel power amplifier to be quickly configured for Main + Main, Mono + Aux 1, or Aux 1 + Aux 2 operation.
- Power amplifier output selector allows selection of 500, 200, or 75 watt output per channel.
- Stand-by switch instantly mutes all mono inputs.
- Precise 12-segment stereo level meter.
- Phones jack with independent level control.
- High-quality SPEAKON speaker connectors for fast, reliable connection. Phone jack connectors are also provided.



Dimensions

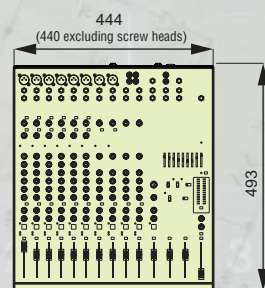

Rear Panel



System Examples

500-watt Mains and Monitor

In this basic system the EMX5014C Speaker A output is driving a pair of parallel-connected S112V speakers for solid front-of-house sound, while an SM12V driven by the Speaker B output serves as a stage monitor.

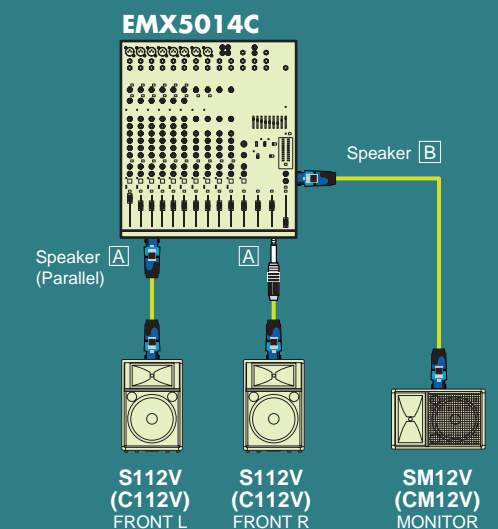

Integrated Solutions for Superior Live Sound

Experienced musicians, performers, speakers, and club operators know the importance of a high-quality sound system with the right features and performance to deliver their sound. Where portability and convenience are important criteria, a system based on a high-performance Yamaha EMX-series powered mixer is definitely the way to go. In one integrated, portable unit you have a mixer to combine and balance your microphone, instrument, and line sources, effects to refine and polish your sound, and power to drive the main speakers and even monitor speakers as well. But that's nowhere near the whole story – Yamaha EMX-series Powered Mixers offer a range of features that let you mix, process, and deliver your sound with maximum quality and creative control ... and, of course, that unrivalled Yamaha sound.



Angled Cabinet for Easy Access

This thoughtful feature makes the control panel easy to see and access when the unit is placed on the floor.

EMX512SC POWERED MIXER

For larger venues and audiences, or if you plan to use it for outdoor sound, the EMX512SC with a pair of whopping 500-watt amplifiers to ensure that your music or message comes across with full impact.

- Up To 8 Mics, 12 Inputs Total
- 2 Stereo inputs
- 500 W + 500 W (4Ω)
- 3-band Channel EQ
- 7-band Stereo Graphic EQ
- One-knob Compression
- FCL System
- SPX Digital Effects
- Power Select Switch
- Standby Mode
- YAMAHA Speaker Processing
- Lightweight Design
- Angled Cabinet
- Rack Mountable



EMX312SC POWERED MIXER

If you need a little more power – 300 watts + 300 watts – and the added advantage of one-knob compression on mono channels, the EMX312SC may be the model you need.

- Up To 8 Mics, 12 Inputs Total
- 2 Stereo inputs
- 300 W + 300 W (4Ω)
- 3-band Channel EQ
- 7-band Stereo Graphic EQ
- One-knob Compression
- FCL System
- SPX Digital Effects
- Power Select Switch
- Standby Mode
- YAMAHA Speaker Processing
- Lightweight Design
- Angled Cabinet
- Rack Mountable



EMX212s POWERED MIXER

The lowest-powered model in the series offers a pair of 220-watt amplifiers per channel that should be more than sufficient for small-to-medium size venues.

- Up To 8 Mics, 12 Inputs Total
- 2 Stereo inputs
- 220 W + 220 W (4Ω)
- 3-band Channel EQ
- 7-band Stereo Graphic EQ
- SPX Digital Effects
- Power Select Switch
- Standby Mode
- YAMAHA Speaker Processing
- Lightweight Design
- Angled Cabinet
- Rack Mountable

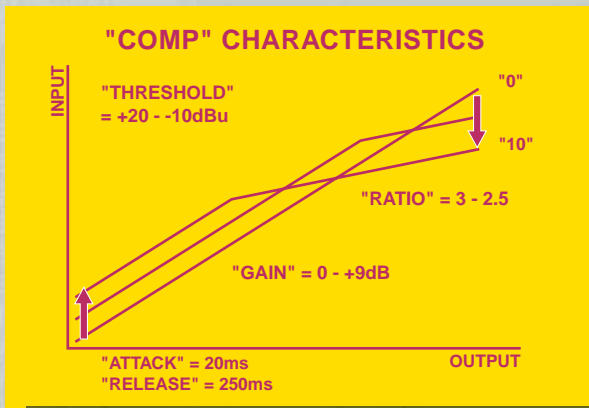

Features For Superior Sound and Convenience

Great Yamaha Sound

Yamaha is a leader in the field of professional live sound for a very good reason: we deliver the sound and performance that the pros demand. The EMX-series powered mixers are no exception. They're built at the same standards of sonic performance and rugged reliability that makes Yamaha the first choice for live sound applications from schools to stadiums around the globe.

One-knob Compression on Mono Channels (EMX512SC & EMX312SC)

All four monaural mic/line channels on the EMX512SC and EMX312SC feature built-in compressors that can help to bring vocals to the front of the mix, give your guitars extra smoothness and presence, deliver a more punchy bass sound, and generally refine your mixes in a multitude of ways. These one-knob compressors are simple to use, too. There's no need to juggle multiple attack, threshold, makeup gain, and other controls – just set the COMP control to the amount of compression you need.

Feedback Channel Locating (FCL) System

FCL System indicator LEDs at the top of each channel light if the corresponding channel goes into feedback, so you won't have to fumble around searching for the channel that needs adjustment.

12 Inputs

All three mixers in this series offer a total of 12 input channels – four for monaural microphone (incl. Phantom Power) or line input, plus four pairs that can function either as monaural microphone inputs or stereo line inputs – providing you with a versatile mix of input capabilities for a wide range of applications. If you need only microphone inputs you can use up to eight mic channels. Or if, for example, you want to play recorded background music during breaks (that's one stereo channel), and you have a keyboard player with a stereo-output keyboard (that's one more stereo channel), you still have six mic/line inputs. If you use all four stereo pairs to handle stereo line sources you have four channels available for mono mic or line input. This is a very versatile system that can adapt to your needs.

High Power For Main and Monitor Speakers

These powered mixers certainly don't skimp on power. From the EMX212S with 200 watts per channel to the EMX512SC with a solid 500 watts per channel, there's a power configuration to suit any application and venue. All models also feature a power mode switch that lets you use the two power channels as a stereo amplifier, or you can use one of the channels for the main speaker(s) and the other to drive monitors with a separate monitor mix set up via the channel MONITOR controls.



SPX Digital Effects

The EMX212S, EMX312SC, and EMX512SC all feature a selection of 16 top-quality Yamaha SPX effects – including reverb, echo, chorus, flanger, phaser, and even distortion – that can add the final touch to your live presentation. Yamaha SPX digital effects are widely recognized as being some of the finest available, and the effects provided in the EMX mixers live up to that reputation.

Built-in Graphic EQ

Graphic equalizers are provided for both the main and monitor channels, so you can effectively control feedback or tailor the sound to the match the room and program material.

Stand-by Mode

When you're done with a set, simply engage the stand-by mode to mute all mono channels while leaving the 2-track inputs active for background music playback while you're taking your break.

Yamaha Speaker Processing

Yamaha Club-series speakers are fine performers in their own right, but with Yamaha Speaker Processing you get extra-smooth highs and enhanced low-frequency output.

Durable, Lightweight Design

The EMX powered mixers offer the ideal combination of outstanding sound performance and easy handling. They're lightweight – only 8 kilograms (17.6 lbs.) – and feature conveniently located handles for maximum carrying comfort. They're also built tough to withstand the rigors of use on the road.



- SPX DIGITAL MULTI EFFECT PROCESSOR
- 1 REVERB HALL 1
 - 2 REVERB HALL 2
 - 3 REVERB ROOM 1
 - 4 REVERB ROOM 2
 - 5 REVERB STAGE 1
 - 6 REVERB STAGE 2
 - 7 REVERB PLATE
 - 8 DRUM AMBIENCE
 - 9 KARAOKE ECHO
 - 10 VOCAL ECHO
 - 11 CHORUS 1
 - 12 CHORUS 2
 - 13 FLANGER
 - 14 PHASER
 - 15 AUTO WAH
 - 16 DISTORTION
- PROGRAM
- PARAMETER
- ON

SPX DIGITAL MULTI EFFECT PROCESSOR



Rear Panel

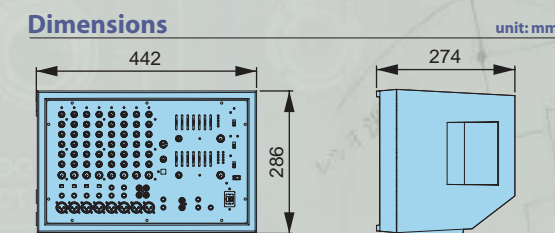



P.T. Yamaha Music manufacturing Asia

—Manufacturing the electronic instruments and PA products

From the initial design to final manufacturing, all production processes for the Yamaha EMX series Powered Mixers are performed entirely inside the company.

Moreover, every product that comes off our production line must pass strict quality controls using the sophisticated test instruments. Thus, all of this enables us to deliver the highest quality products to you.

An Interview with the EMX Design Team
Built-in Compression Adds Live-sound Versatility to the new EMX-series Powered Mixers

New Features

- What is the main difference compared to previous EMX-series mixers?
The main difference is built-in compression. Compression is indispensable in almost all professional recording and live-sound applications, but we believe that this is the first time it has been built into an analog live mixer.
- Most "box type" mixers have no insert connectors, so there has really been no convenient way to use compression with them. As a result, many users of this type of powered mixer have never used compression, but we wanted them to have that option in the new EMX series.
- Although compression is used in most pro audio applications, it has been a bit too difficult for beginners to take full advantage of. That's why we've streamlined it down to the essentials and made it very easy to use.
- Another important new feature is FCL (Feedback Channel Location). This system detects feedback and shows you which channel is causing the problem. Some mixers from other manufacturers have indicators in the graphic equalizer section that show the feedback frequency, but indicating the problem channel allows the feedback to be more effectively controlled using channel EQ.
- If you try to control feedback using the EMX graphic equalizer, for example, you end up changing the sound of the entire program. For this reason it is far more effective to control it at the input, thus avoiding degradation of the overall sound.

The Battle Against Heat

- Tell us about how you avoided heat problems in such compact enclosures.
Heat and high power output unavoidably go hand-in-hand. In this case we were also determined to reduce weight, so the design, hardware, and mechanics teams joined forces to pursue this goal. Changing even a single component can alter the heat profile enough to require a change in heat sink design, and that change can cause a change in sound quality, so the design process involves a lot of trial and error.
- In this particular case, the fact that we were able to use internal heat-flow simulation and analysis was a huge advantage. We were able to define an enclosure shape on the computer, and then by analyzing the heat flow while refining the heat sink configuration we were able to come to within 80% or 90% of the ideal final design. The final stages using physical prototypes still relied on trial and error.

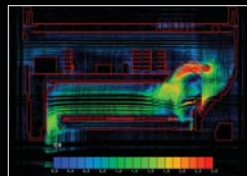

- In the box-type 212C, 312SC, and 512SC, it was easy to mount the fan away from the circuit board to minimize degradation of the audio signal. But in the console-type EMX5014C finding the ideal fan location was extremely difficult. Since the fan must be located near the input circuitry, special measures have been taken to ensure that electronic and mechanical noise from the fan do not affect sound quality, while at the same time ensuring maximum heat extraction.

- The hardware team wanted to increase the size of the body by 30 millimeters, but our goals for a streamlined, compact design were important enough that we decided to find other ways to achieve the desired performance.

Reliability Without Compromising Performance

- The simplicity and aesthetic appeal of the designs are quite impressive. Tell us about the design concept.
Simplicity was the main goal, particularly in the console-type 5014C. We wanted to consolidate the mixer controls, so the utility control section has been clearly separated. We didn't even want any handles to be visible.
- An important idea implemented in the box-type models is that they can be set at an angle like monitor speakers. The integral handles are also an important design feature, and achieving the required strength was a constant problem.

- Achieving the ideal blend of size, weight, and durability is quite difficult. As usual, demands from the sales team continue to escalate while the hardware and mechanics teams try to turn them into reality ... without ever reducing or compromising features or performance. Computer simulation was called into play once again, providing an accurate preview of the mold-flow characteristics of the resin used for the box-type housings.

- The final strength of the molded housings depends to a large degree on how the molten resin is introduced in the mold, and how it flows within the mold.

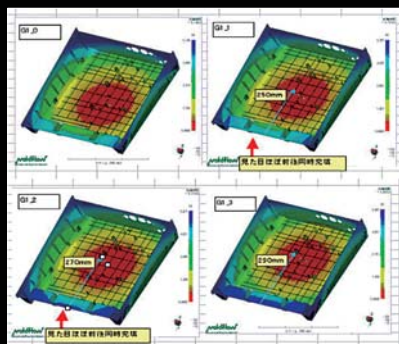

- The strength of the integral handles was also predicted using computer simulation, and as a result, we have achieved strength comparable to that of aluminum.

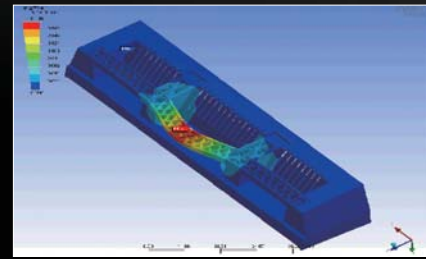

Achieving Pure Sound Quality

- What measures have been taken to ensure optimum sound quality?
Of course sound quality is first and foremost in the design of any model. Achieving the lowest possible noise and hum when changing components is always a challenge. There's influence from vibration, from the current flowing through the components themselves, and a simple op-amp IC change can precipitate a large change in sound. We often find ourselves using the best components we can find rather than compromise on sound quality. Even the FCL system has an effect on the sound, and we were able to achieve a dramatic improvement by simply eliminating a single component from the circuit. Once again, the final design depends on trial-and-error listening tests while changing components.
- With SPX effects in all models in this EMX series, plus compression and FCL, you can rely on a single EMX powered mixer to deliver outstanding live sound, especially in applications that use mostly microphones.

- Most compressors have at least two controls, what is the idea behind having just one?
Simplicity. Standard compression controls can be very difficult to set quickly and accurately, but we've managed to provide well-balanced threshold and ratio settings that can be controlled by a single knob. By focusing primarily on microphone applications in which compression is applied to vocals, acoustic guitar, or similar sources, great-sounding compression can be dialed in quickly and easily.

- There's a good description of compression and its uses in the owner's manual. We hope that our users will take advantage of this very useful feature.

EMX5014C Block and Level Diagram

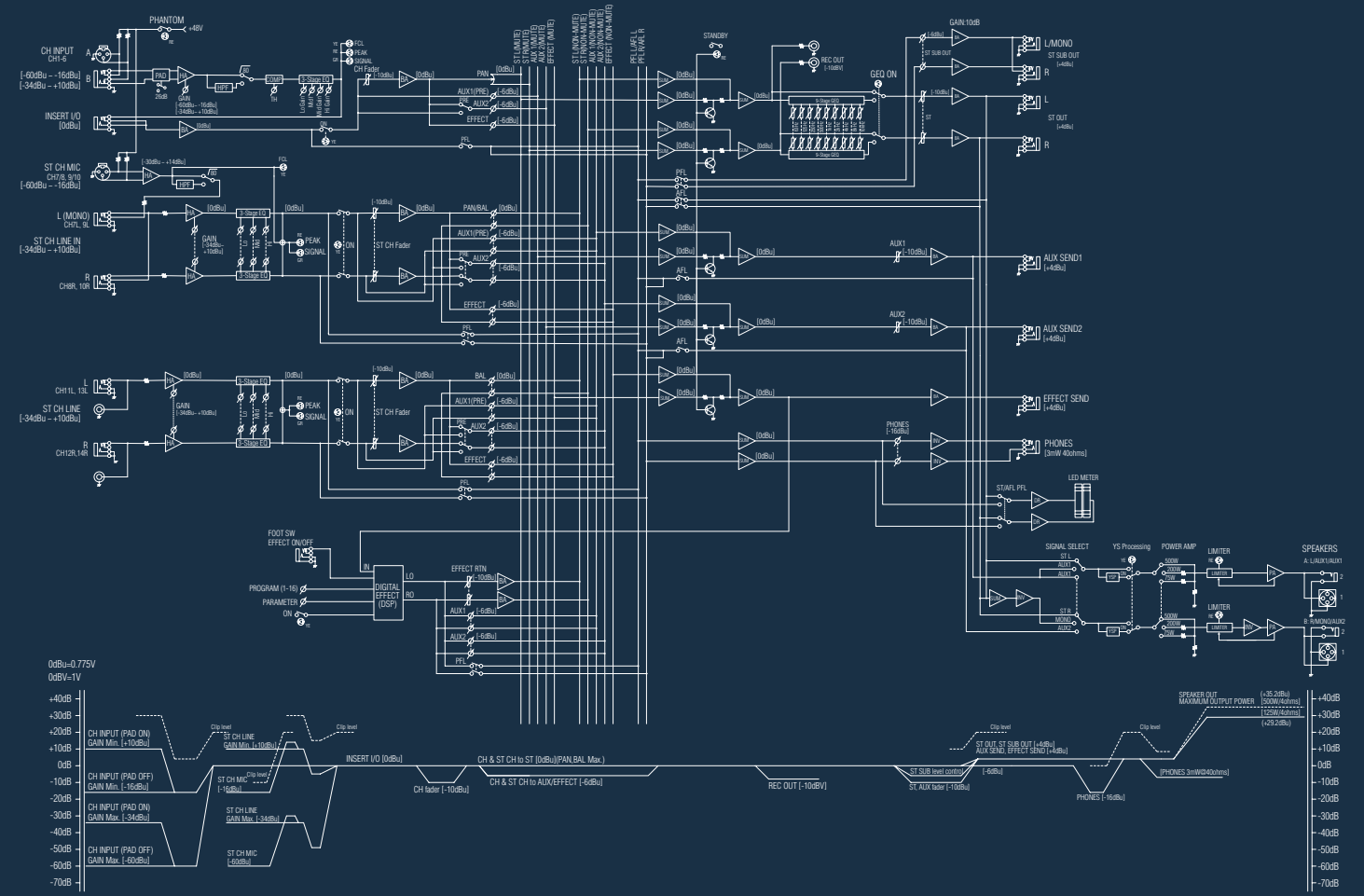

EMX512SC, EMX312SC, EMX212S Block and Level Diagram

